



Chipsmall Limited consists of a professional team with an average of over 10 year of expertise in the distribution of electronic components. Based in Hongkong, we have already established firm and mutual-benefit business relationships with customers from,Europe,America and south Asia,supplying obsolete and hard-to-find components to meet their specific needs.

With the principle of “Quality Parts,Customers Priority,Honest Operation,and Considerate Service”,our business mainly focus on the distribution of electronic components. Line cards we deal with include Microchip,ALPS,ROHM,Xilinx,Pulse,ON,Everlight and Freescale. Main products comprise IC,Modules,Potentiometer,IC Socket,Relay,Connector.Our parts cover such applications as commercial,industrial, and automotives areas.

We are looking forward to setting up business relationship with you and hope to provide you with the best service and solution. Let us make a better world for our industry!



Contact us

Tel: +86-755-8981 8866 Fax: +86-755-8427 6832

Email & Skype: info@chipsmall.com Web: www.chipsmall.com

Address: A1208, Overseas Decoration Building, #122 Zhenhua RD., Futian, Shenzhen, China



GP-X SERIES

Related Information

- General terms and conditions..... F-7
- Sensor selection guide..... P.1055~
- Glossary of terms..... P.1493
- General precautions P.1501



High-speed sampling and high resolution. The new choice for even more variegated data collection and processing.

They perform with a $\pm 0.3\%$ F.S. linearity for stainless steel and iron

Because they perform with a $\pm 0.3\%$ F.S. linearity, they can be used for sensing stainless steel and iron enabling precise measurements not affected by the work's material. Specifications corresponding to each material (stainless steel, iron, aluminum) has already been inputted in the controller enabling the easy selection of the setting that is most suitable for the particular material used.

Optimal correction of the output feature

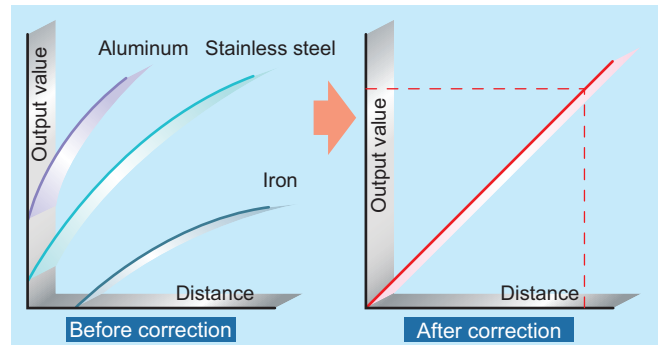

We've realized a 25 μ s (40,000 times/sec.) ultra high sampling speed

With a 25 μ s ultra high sampling speed, the GP-X series won't miss even high speed work displacements.

They possess a 0.02 % F.S. resolution for highly accurate measurement

With high resolution, 0.02 % F.S. (Note), they can perform high-accuracy measurements of micro-displacements. In particular, the sensor head GP-X3SE for 0.8 mm 0.049 in sensing can differentiate ultra micro displacement of 0.32 μ m 0.013 mil (Average number of samples: 64).
 Note: GP-XC3SE and GP-XC5SE
 Resolution: 0.04 % F.S.

These devices boast a 0.07 % F.S./ $^{\circ}$ C temperature characteristics

By combining the sensor head with the controller, we've realized 0.07 % F.S./ $^{\circ}$ C. They are highly resistant to ambient temperature changes enabling stable micro-displacement measurements.

- FIBER SENSORS
- LASER SENSORS
- PHOTOELECTRIC SENSORS
- MICRO PHOTOELECTRIC SENSORS
- AREA SENSORS
- LIGHT CURTAINS / SAFETY COMPONENTS
- PRESSURE / FLOW SENSORS
- INDUCTIVE PROXIMITY SENSORS
- PARTICULAR USE SENSORS
- SENSOR OPTIONS
- SIMPLE WIRE- SAVING UNITS
- WIRE- SAVING SYSTEMS
- MEASUREMENT SENSORS
- STATIC ELECTRICITY PREVENTION DEVICES
- LASER MARKERS
- PLC
- HUMAN MACHINE INTERFACES
- ENERGY CONSUMPTION VISUALIZATION COMPONENTS
- FA COMPONENTS
- MACHINE VISION SYSTEMS
- UV CURING SYSTEMS

- Selection Guide
- Laser Displacement
- Magnetic Displacement
- Collimated Beam
- Digital Panel Controller
- Metal-sheet Double-feed Detection

- GP-X
- GP-A

APPLICATIONS

Stroke end sensing

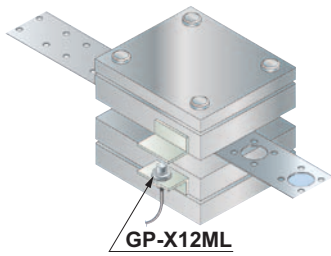

Eccentricity sensing



Height sensing

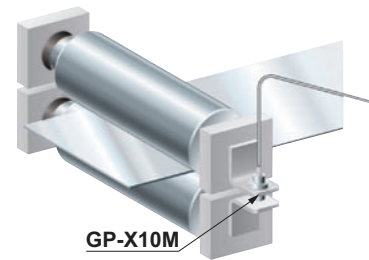

ENVIRONMENTAL RESISTANCE / VARIETY

IP67G sensor head variation

6 types of sensor heads from the ultra compact $\varnothing 3.8$ mm $\varnothing 0.150$ in cylindrical type to the long range sensing type $\varnothing 22$ mm $\varnothing 0.866$ in are available. All sensor heads are oil-proof as per IP67G enabling safe, stable performance even under harsh environments.

Controller
NPN output type,
PNP output type
DIN $\square 48$ mm $\square 1.890$ in size

GP-X22KL Sensing range: 0 to 10 mm 0 to 0.394 in Appearance: $\varnothing 22$ mm $\varnothing 0.866$ in / M12	GP-X12ML Sensing range: 0 to 5 mm 0 to 0.197 in Appearance: M12	GP-X10M Sensing range: 0 to 2 mm 0 to 0.079 in Appearance: M10	GP-X3SE Sensing range: 0 to 0.8 mm 0 to 0.031 in Appearance: $\varnothing 3.8$ mm $\varnothing 0.150$ in	GP-X5SE Sensing range: 0 to 1 mm 0 to 0.039 in Appearance: $\varnothing 5.4$ mm $\varnothing 0.213$ in	GP-X8S Sensing range: 0 to 2 mm 0 to 0.079 in Appearance: $\varnothing 8$ mm $\varnothing 0.315$ in
---	---	--	--	--	---

MOUNTING / MAINTENANCE

Sensor heads with superior workability and maintainability

Replacement of sensor heads possible

As a result of damage or other mishap rendering maintenance necessary, you can replace the sensor head with new one leaving the controller as it is.

One-touch connector hook up

The sensor head and the controller connection is a simple one-touch connector type.



Sensor head extensions possible

Between the sensor head and the controller, a **GP-XCCJ7** extension cable (optional) can be used up to a 10 m **32.808 ft** total length.

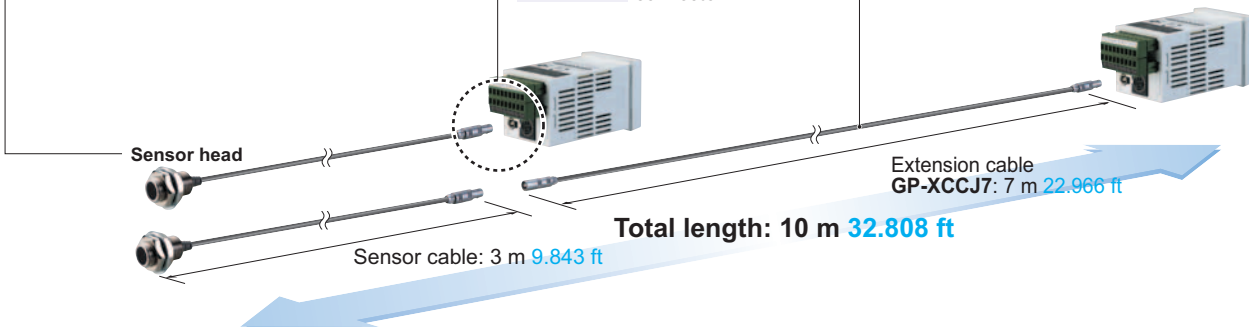

FIBER SENSORS

LASER SENSORS

PHOTOELECTRIC SENSORS

MICRO PHOTOELECTRIC SENSORS

AREA SENSORS

LIGHT CURTAINS / SAFETY COMPONENTS

PRESSURE / FLOW SENSORS

INDUCTIVE PROXIMITY SENSORS

PARTICULAR USE SENSORS

SENSOR OPTIONS

SIMPLE WIRE-SAVING UNITS

WIRE-SAVING SYSTEMS

MEASUREMENT SENSORS

STATIC ELECTRICITY PREVENTION DEVICES

LASER MARKERS

PLC

HUMAN MACHINE INTERFACES

ENERGY CONSUMPTION VISUALIZATION COMPONENTS

FA COMPONENTS

MACHINE VISION SYSTEMS

UV CURING SYSTEMS

- Selection Guide
- Laser Displacement
- Magnetic Displacement
- Collimated Beam
- Digital Panel Controller
- Metal-sheet Double-feed Detection

GP-X

GP-A

FIBER SENSORS
LASER SENSORS
PHOTOELECTRIC SENSORS
MICRO PHOTOELECTRIC SENSORS
AREA SENSORS
LIGHT CURTAINS / SAFETY COMPONENTS
PRESSURE / FLOW SENSORS
INDUCTIVE PROXIMITY SENSORS
PARTICULAR USE SENSORS
SENSOR OPTIONS
SIMPLE WIRE-SAVING UNITS
WIRE-SAVING SYSTEMS
MEASUREMENT SENSORS
STATIC ELECTRICITY PREVENTION DEVICES
LASER MARKERS
PLC
HUMAN MACHINE INTERFACES
ENERGY CONSUMPTION VISUALIZATION COMPONENTS
FA COMPONENTS
MACHINE VISION SYSTEMS
UV CURING SYSTEMS
Selection Guide
Laser Displacement
Magnetic Displacement
Collimated Beam
Digital Panel Controller
Metal-sheet Double-feed Detection

FUNCTIONS

The 5-digit, dual, 2-color digital display offers great visibility

If the measurement results fall within the setting range (GO), they will appear on the lower digital display in green. If they are out of range (HI, LO), they will be displayed in the upper digital display in orange. The display position and color change allows for accurate visibility even for momentary changes.

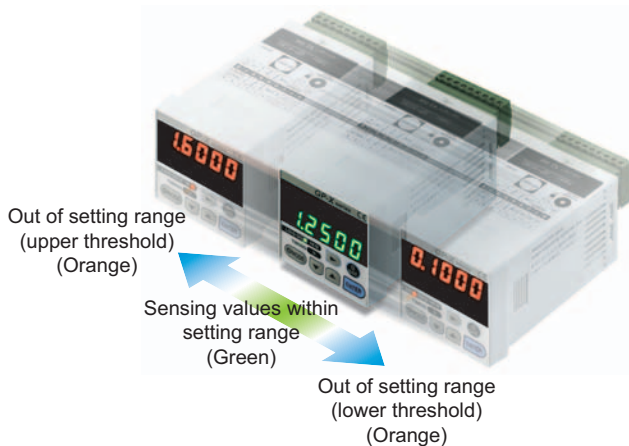

Digital input display enabling easy setting

Its dual digital display enables numerical setting while verifying setting items for each mode. Even when sensing, it enables the verification of the main settings.

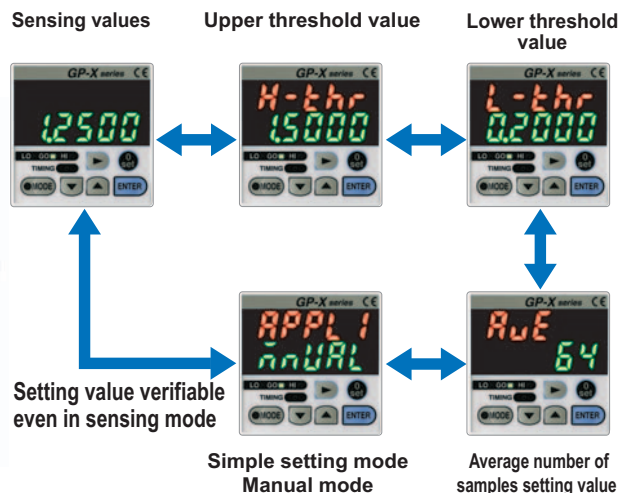

The RS-232C communication connector is standard equipment

It is capable of various controls such as saving measurement data to PC and the controller's inputted settings and loading stored memory.

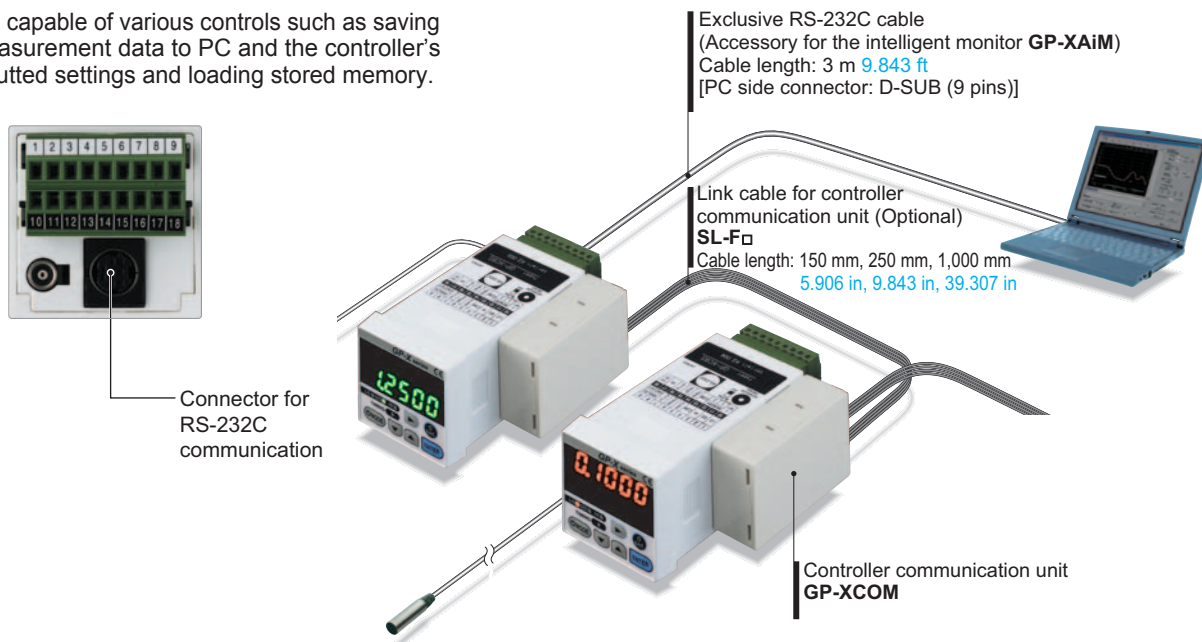

Enables sensors data comparisons and calculations

3-value judgment output for calculating measurement data conformity and calculation results between 2 interconnected controllers is rendered possible. The calculation function equipment renders digital panel controllers unnecessary.

GP-X
GP-A

OPTIONS

Datalink between sensors possible

The controller communication unit **GP-XCOM** (optional) can be linked to up to 8 controllers and load via just one RS-232C cable each controller settings and measurement data to a PC.

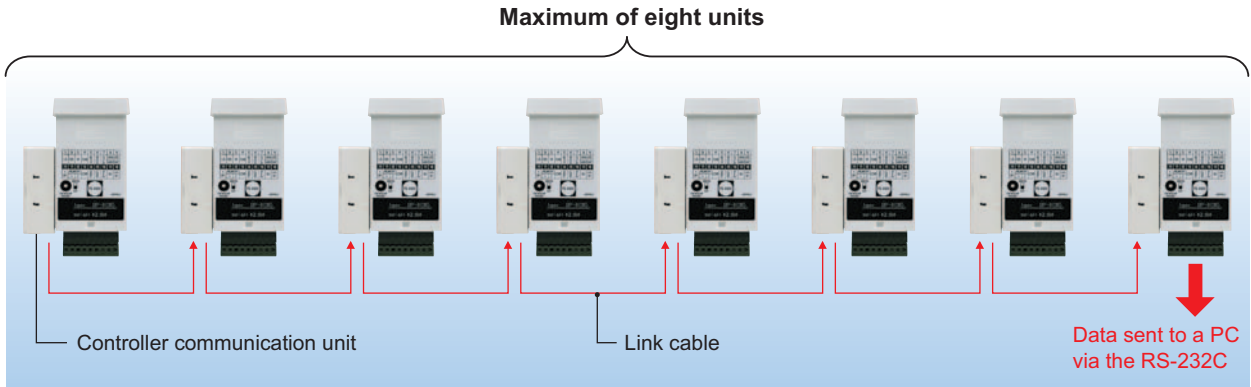

An intelligent monitor (GP-XAiM) optimal for collecting and analyzing measurement data is also available

An intelligent monitor capable of the settings for each measurement conditions and waveform display monitoring. It can perform waveform monitoring, which could until now only be done by the oscilloscope, as well as the simple loading and saving onto a PC of settings for each condition and function. (Exclusive RC-232C cable is attached.)



BCD output unit GP-XBCD (Optional)

20 kHz high-speed data output

The measurement data can be processed quickly in the PLC. (Sampling rate: 20 kHz)

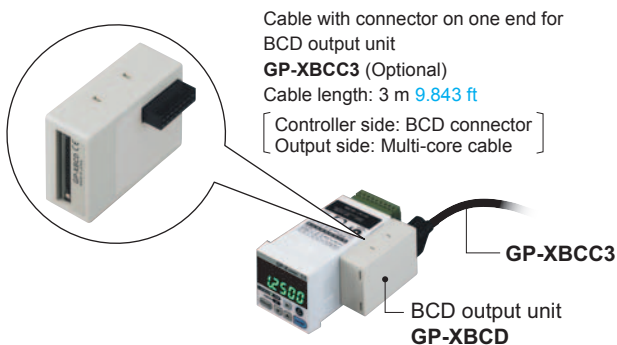

4 types of measurement modes available

Measurement modes compatible to the most widely used applications are available. Because of this, inputting setting values can be done with ease. Please select the most appropriate mode to suit your specific application.

Mutual interference prevention function

The sensor head can be made interference prevention by linking up to 8 controllers via an interference prevention output cable and shifting the oscillation timing. This enables precise measurements to be obtained even in cases where many sensor heads are crowded in the same area.

Removable type terminal block

It is equipped with a removable type European terminal block very convenient during assembly, when dividing the equipment into segments or when performing maintenance. It also features an reverse insertion prevention construction.

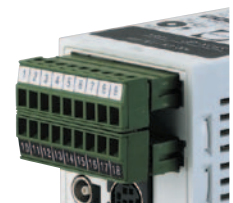

European terminal block

4 types of selectable memory functions

The setting data can be processed in 4 types of memory when measuring. This function enables either the changing of the workpiece, the sensing of multiple products or sensing after product changeover to be done smoothly.

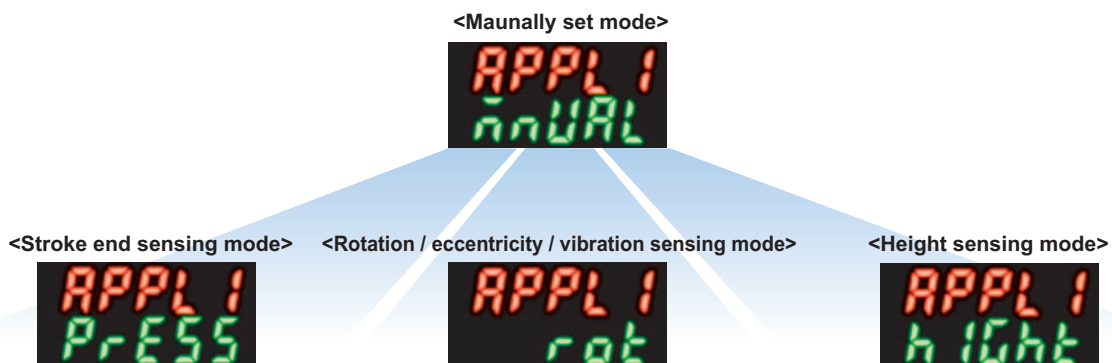

FIBER SENSORS

LASER SENSORS

PHOTOELECTRIC SENSORS

MICRO PHOTOELECTRIC SENSORS

AREA SENSORS

LIGHT CURTAINS / SAFETY COMPONENTS

PRESSURE / FLOW SENSORS

INDUCTIVE PROXIMITY SENSORS

PARTICULAR USE SENSORS

SENSOR OPTIONS

SIMPLE WIRE-SAVING UNITS

WIRE-SAVING SYSTEMS

MEASUREMENT SENSORS

STATIC ELECTRICITY PREVENTION DEVICES

LASER MARKERS

PLC

HUMAN MACHINE INTERFACES

ENERGY CONSUMPTION VISUALIZATION COMPONENTS

FA COMPONENTS

MACHINE VISION SYSTEMS

UV CURING SYSTEMS

Selection Guide

Laser Displacement

Magnetic Displacement

Collimated Beam

Digital Panel Controller





Metal-sheet Double-feed Detection

GP-X

GP-A

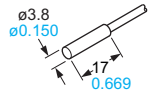
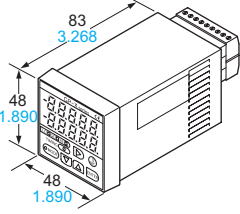
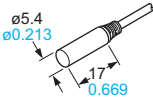
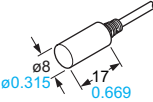
ORDER GUIDE

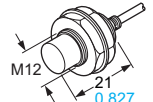
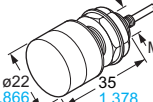
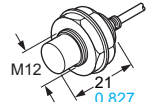
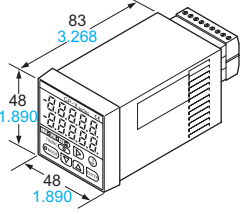
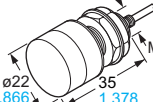
- FIBER SENSORS
- LASER SENSORS
- PHOTO-ELECTRIC SENSORS
- MICRO PHOTO-ELECTRIC SENSORS
- AREA SENSORS
- LIGHT CURTAINS/SAFETY COMPONENTS
- PRESSURE / FLOW SENSORS
- INDUCTIVE PROXIMITY SENSORS
- PARTICULAR USE SENSORS
- SENSOR OPTIONS
- SIMPLE WIRE-SAVING UNITS
- WIRE-SAVING SYSTEMS
- MEASURE-HEAT SENSORS
- STATIC ELECTRICITY PREVENTION DEVICES
- LASER MARKERS
- PLC
- HUMAN MACHINE INTERFACES
- ENERGY CONSUMPTION VISUALIZATION COMPONENTS
- FA COMPONENTS
- MACHINE VISION SYSTEMS
- UV CURING SYSTEMS

Type	Appearance (mm in)		Sensing range	Set model No. (Sensor head model No.)	Comparative output
	Sensor heads	Controller			
Non-threaded type sensor head			0 to 0.8 mm 0 to 0.031 in	GP-XC3SE (GP-X3SE)	NPN open-collector transistor
			0 to 1 mm 0 to 0.039 in	GP-XC5SE (GP-X5SE)	NPN open-collector transistor
			0 to 2 mm 0 to 0.079 in	GP-XC8S (GP-X8S)	NPN open-collector transistor
			0 to 2 mm 0 to 0.079 in	GP-XC8S-P (GP-X8S)	PNP open-collector transistor
			0 to 2 mm 0 to 0.079 in	GP-XC10M (GP-X10M)	NPN open-collector transistor
			0 to 2 mm 0 to 0.079 in	GP-XC10M-P (GP-X10M)	PNP open-collector transistor
Threaded type sensor head			0 to 5 mm 0 to 0.197 in	GP-XC12ML (GP-X12ML)	NPN open-collector transistor
			0 to 5 mm 0 to 0.197 in	GP-XC12ML-P (GP-X12ML)	PNP open-collector transistor
			0 to 10 mm 0 to 0.394 in	GP-XC22KL (GP-X22KL)	NPN open-collector transistor
			0 to 10 mm 0 to 0.394 in	GP-XC22KL-P (GP-X22KL)	PNP open-collector transistor

- Selection Guide
- Laser Displacement
- Magnetic Displacement
- Collimated Beam
- Digital Panel Controller
- Metal-sheet Double-feed Detection

GP-X

GP-A

OPTIONS

Designation	Model No.	Description	
BCD output unit	GP-XBCD	This unit outputs measurement values in BCD data format at a high speed. • Sampling frequency: 20 kHz	
Cable with connector on one end for BCD output unit	GP-XBCC3	Length: 3 m 9.843 ft	Cable for BCD data output unit • 26-core cable with connector on one end
Controller communication unit	GP-XCOM	Up to 8 controllers can be linked	
Link cable for controller communication unit	SL-F150	Length: 150 mm 5.906 in	This cable links the controller communication units. Select as per the cable length.
	SL-F250	Length: 250 mm 9.843 in	
	SL-F1000	Length: 1,000 mm 39.370 in	
Intelligent monitor	GP-XAiM	Monitoring settings for each measurement condition and measurement waveforms is enabled by way of a PC. • One exclusive RS-232C cable (3 m 9.843 ft length) is attached.	
Extension cable for sensor head	GP-XCCJ7	Length: 7 m 22.966 ft	This cable with connector is for extensions between the sensor head and controller.
Sensor head mounting bracket	MS-SS3	Mounting bracket for GP-X3SE	
	MS-SS5	Mounting bracket for GP-X5SE	
	MS-SS8	Mounting bracket for GP-X8S	

BCD output unit
Cable with connector on one end for BCD output unit

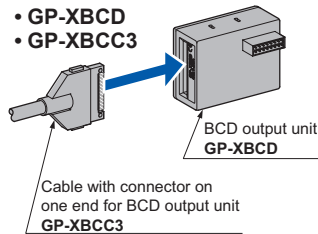

Controller communication unit
Link cable for controller communication unit

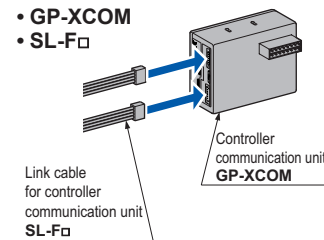

Intelligent monitor

- **GP-XAiM**



Extension cable for sensor head

- **GP-XCCJ7**

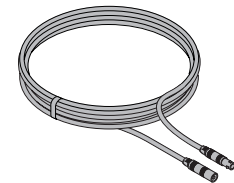

Sensor head mounting bracket

- **MS-SS□**

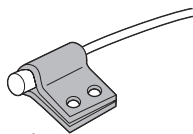

The sensor head can be easily fixed.

FIBER SENSORS

LASER SENSORS

PHOTO-ELECTRIC SENSORS

MICRO PHOTO-ELECTRIC SENSORS

AREA SENSORS

LIGHT CURTAINS / SAFETY COMPONENTS

PRESSURE / FLOW SENSORS

INDUCTIVE PROXIMITY SENSORS

PARTICULAR USE SENSORS

SENSOR OPTIONS

SIMPLE WIRE-SAVING UNITS

WIRE-SAVING SYSTEMS

MEASUREMENT SENSORS

STATIC ELECTRICITY PREVENTION DEVICES

LASER MARKERS

PLC

HUMAN MACHINE INTERFACES

ENERGY CONSUMPTION VISUALIZATION COMPONENTS

FA COMPONENTS

MACHINE VISION SYSTEMS

UV CURING SYSTEMS

Selection Guide

Laser Displacement

Magnetic Displacement

Collimated Beam

Digital Panel Controller

Metal-sheet Double-feed Detection

GP-X

GP-A

SPECIFICATIONS

Controllers

Item	Type	NPN output	PNP output
	Set model No.	GP-XC□	GP-XC□-P
Supply voltage	24 V DC ±10 % Ripple P-P 10 % or less		
Current consumption	150 mA or less		
Resolution (Note 2)	GP-XC3SE / GP-XC5SE: 0.04 % F.S. (64 times average processing) GP-XC8S / GP-XC10M / GP-XC12ML / GP-XC22KL: 0.02 % F.S. (64 times average processing)		
Sampling frequency	40 kHz (25 μs)		
Linearity (Note 2)	Within ±0.3 % F.S.		
Temperature characteristics (Note 3)	0.07 % F.S./°C or less		
Analog voltage outputs	Output voltage: -5 to +5 V (Note 4), Output impedance: 100 Ω approx.		
Response time	75 μs (maximum speed)		
Comparative outputs (HI, GO, LO)	NPN open-collector transistor <ul style="list-style-type: none"> • Maximum sink current: 100 mA • Applied voltage: 30 V DC or less (between comparative output and 0 V) • Residual voltage: 1.6 V or less (at 100 mA sink current) 0.4 V or less (at 16 mA sink current) 	PNP open-collector transistor <ul style="list-style-type: none"> • Maximum source current: 100 mA • Applied voltage: 30 V DC or less (between comparative output and +V) • Residual voltage: 1.6 V or less (at 100 mA source current) 0.4 V or less (at 16 mA source current) 	
Utilization category	DC-12 or DC-13		
Output number	HI / GO / LO 3 value output		
Output operation	HI : ON when measured value > the upper limit value GO: ON when upper limit value ≥ measured value ≥ lower limit value LO : ON when lower limit value > measured value		
Short-circuit protection	Incorporated		
External input	Photo-coupler input <ul style="list-style-type: none"> • Input current: 9 mA or less • Operating voltage: ON voltage 17 V or more (between +24 V and input) OFF voltage 4 V or less (between +24 V and input) • Input impedance: 5 kΩ approx. 	Photo-coupler input <ul style="list-style-type: none"> • Input current: 9 mA or less • Operating voltage: ON voltage 17 V or more (between 0 V and input) OFF voltage 4 V or less (between 0 V and input) • Input impedance: 5 kΩ approx. 	
Serial I/O	RS-232C		
Zero-set setting method	Push button setting / External input setting		
Indicators	MODE	Orange LED (lights up when in mode status)	
	HI	Orange LED (lights up when the upper limit value is exceeded)	
	GO	Green LED (lights up when within the upper and lower limit value)	
	LO	Orange LED (lights up when less than the lower limit value)	
	TIMING	Green LED (lights up as per the external or internal trigger timing)	
Upper level digital display part	5 digit orange LED (display of numerical values out of upper and lower limit value)		
Lower level digital display part	5 digit green LED (display of numerical values within the upper and lower limit value)		
Environmental resistance	Pollution degree	3 (Industrial environment)	
	Ambient temperature	0 to +50 °C +32 to +122 °F (No dew condensation), Storage: 0 to +50 °C +32 to +122 °F	
	Ambient humidity	35 to 85 % RH, Storage: 35 to 85 % RH	
	EMC	EN 61000-6-2, EN 61000-6-4	
	Vibration resistance	10 to 55 Hz frequency, 0.75 mm 0.030 in amplitude in X, Y and Z directions for two hours each	
	Shock resistance	100 m/s ² acceleration (10 G approx.) in X, Y and Z directions for five times each	
Material	Enclosure: Polycarbonate		
Weight	Net weight: 120 g approx.		
Accessory	ATA4811 (Controller mounting frame): 1 set		

Notes: 1) Where measurement conditions have not been specified precisely, the conditions used were an ambient temperature of +20 °C +68 °F.

2) This value was obtained at a constant +25 °C +77 °F.

3) This value represents 20 to 60 % of the maximum sensing distance when combining the sensor head and controller.

4) Adjusted to a 0 to +5 V factory setting.

SPECIFICATIONS**Sensor heads**

Item	Model No.	Non-threaded type			Threaded type		
		For 0.8 mm 0.031 in sensing	For 1 mm 0.039 in sensing	For 2 mm 0.079 in sensing	For 2 mm 0.079 in sensing	For 5 mm 0.197 in sensing	For 10 mm 0.394 in sensing
		GP-X3SE	GP-X5SE	GP-X8S	GP-X10M	GP-X12ML	GP-X22KL
Sensing range (Note 2)		0 to 0.8 mm 0 to 0.031 in	0 to 1 mm 0 to 0.039 in	0 to 2 mm 0 to 0.079 in	0 to 2 mm 0 to 0.079 in	0 to 5 mm 0 to 0.197 in	0 to 10 mm 0 to 0.394 in
Standard sensing object		Stainless steel (SUS304) / Iron sheet [Cold rolled carbon steel (SPCC)] 60 × 60 × t 1 mm 2.362 × 2.362 × t 0.039 in					
Temperature characteristics (Note 3)		0.07 % F.S./°C or less					
Environmental resistance	Pollution degree	3 (Industrial environment)					
	Protection	IP67 (IEC), IP67G					
	Ambient temperature	-10 to +55 °C +14 to +131 °F , Storage: -20 to +70 °C -4 to +158 °F					
	Ambient humidity	35 to 85 % RH, Storage: 35 to 85 % RH					
	Voltage withstandability	250 V AC for one min. between all supply terminals connected together and enclosure					
	Insulation resistance	20 MΩ, or more, with 250 V DC megger between all supply terminals connected together and enclosure					
	Vibration resistance	10 to 150 Hz frequency, 0.75 mm 0.030 in amplitude in X, Y and Z directions for two hours each					
	Shock resistance	500 m/s ² acceleration (50 G approx.) in X, Y and Z directions for five times each					
Material	Enclosure	Stainless steel (SUS303)			Brass (Nickel plated)		
	Cable protector	PP					
	Sensing part	ABS	PAR	ABS	PA		
Cable	High frequency coaxial cable with connector, 3 m 9.843 ft long (Note 4)						
Cable extension	Extension up to total 10 m 32.808 ft is possible with the optional cable.						
Net Weight (Note 5)		40 g approx.	40 g approx.	40 g approx.	50 g approx.	45 g approx.	80 g approx.
Accessories					Nut: 2 pcs., Toothed lock washer: 1 pc.		

Notes: 1) Where measurement conditions have not been specified precisely, the conditions used were an ambient temperature of +20 °C **+68 °F**.

2) The sensing range is specified for the standard sensing object.

3) This value represents 20 to 60 % of the maximum sensing distance when combining the sensor head and the controller.

4) For the flexible cable type, please contact our office.

5) The given weight of the threaded type sensor head is the value including the weight of the nuts and the toothed lock washer.

BCD output unit

Item	Model No.	GP-XBCD
Current consumption		20 mA or less
Outputs (5 digits BCD, Polarity indication, VALID)		N-channel MOSFET open drain <ul style="list-style-type: none"> • Maximum sink current: 50 mA • Applied voltage: 30 V DC or less (between output and GND) • Residual voltage: 1 V or less (at 50 mA sink current)
Hold input		Non-voltage contact or NPN open-collector transistor input <ul style="list-style-type: none"> • Low: 0 to 1 V • High: Open
Material		Enclosure: ABS
Weight		Net weight: 30 g approx.
Accessory		Mounting bracket [Stainless steel (SUS304)]: 1 pc.

Note: Connects to the control device with **GP-XBCC3** cable with connector on one end for BCD output unit (3 m **9.843 ft** cable length, optional).

Controller communication unit

Item	Model No.	GP-XCOM
Current consumption		5 mA or less
Material		Enclosure: ABS
Weight		Net weight: 20 g approx.
Accessory		Mounting bracket [Stainless steel (SUS304)]: 1 pc.

Note: Each **GP-XCOM** is connected using a link cable for controller communication units (**SL-F□**, optional).

When **GP-XCOM** is used, controllers cannot communicate if their software versions are not compatible (Ver. 1.06 or earlier version with Ver 2.00 or later version).

Check the software version and use the correct combination.

FIBER SENSORS

LASER SENSORS

PHOTO-ELECTRIC SENSORS

MICRO PHOTO-ELECTRIC SENSORS

AREA SENSORS

LIGHT CURTAINS / SAFETY COMPONENTS

PRESSURE / FLOW SENSORS

INDUCTIVE PROXIMITY SENSORS

PARTICULAR USE SENSORS

SENSOR OPTIONS

SIMPLE WIRE-SAVING UNITS

WIRE-SAVING SYSTEMS

MEASUREMENT SENSORS

STATIC ELECTRICITY PREVENTION DEVICES

LASER MARKERS

PLC

HUMAN MACHINE INTERFACES

ENERGY CONSUMPTION VISUALIZATION COMPONENTS

FA COMPONENTS

MACHINE VISION SYSTEMS

UV CURING SYSTEMS

Selection Guide

Laser Displacement

Magnetic Displacement

Collimated Beam

Digital Panel Controller

Metal-sheet Double-feed Detection

GP-X**GP-A**

- FIBER SENSORS
- LASER SENSORS
- PHOTO-ELECTRIC SENSORS
- MICRO PHOTO-ELECTRIC SENSORS
- AREA SENSORS
- LIGHT CURTAINS/SAFETY COMPONENTS
- PRESSURE / FLOW SENSORS
- INDUCTIVE PROXIMITY SENSORS
- PARTICULAR USE SENSORS
- SENSOR OPTIONS
- SIMPLE WIRE-SAVING UNITS
- WIRE-SAVING SYSTEMS
- MEASURE-NEXT SENSORS
- STATIC ELECTRICITY PREVENTION DEVICES
- LASER MARKERS
- PLC
- HUMAN MACHINE INTERFACES
- ENERGY CONSUMPTION VISUALIZATION COMPONENTS
- FA COMPONENTS
- MACHINE VISION SYSTEMS
- UV CURRING SYSTEMS

I/O CIRCUIT AND WIRING DIAGRAMS

NPN output type controller

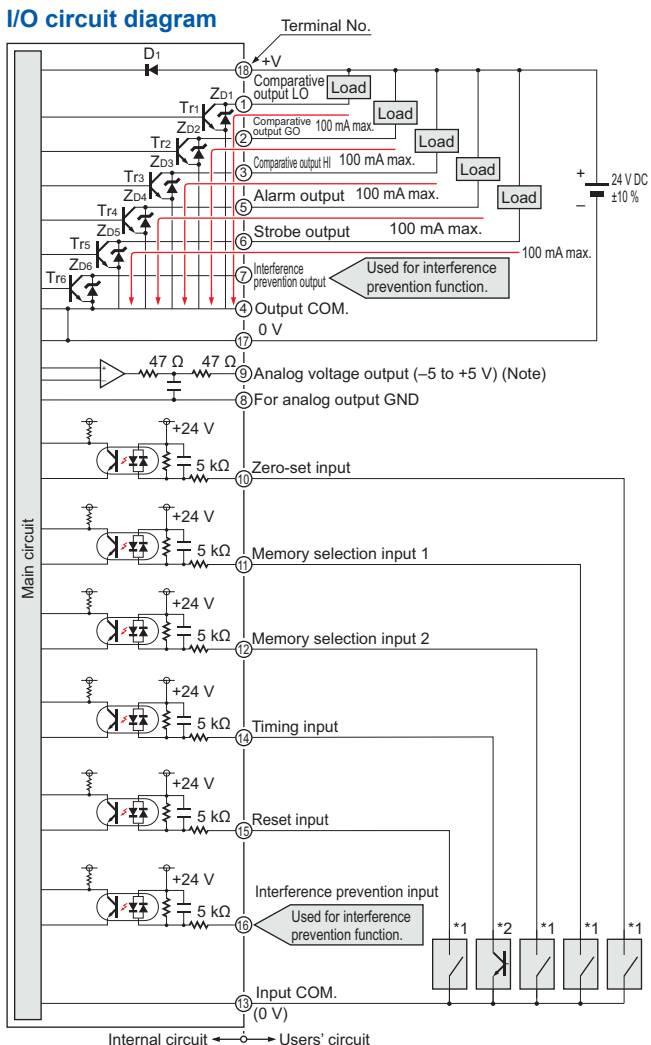

Note: Devices connected to the analog voltage output must have an input impedance set at 1 MΩ or more.

Symbols ... D1: Reverse supply polarity protection diode
ZD1 to ZD6: Surge absorption zener diode
Tr1 to Tr6: NPN output transistor

* 1

Non-voltage contact or NPN open-collector transistor

- Zero-set input, reset input, memory selection input
Low (0 to 4 V): Effective
High (+V or open): Ineffective

* 2

NPN open-collector transistor

- Timing input
Low (0 to 4 V): Effective
High (+V or open): Ineffective

Memory selection input

Memory No.	Memory selection 1	Memory selection 2
0	High	High
1	Low	High
2	High	Low
3	Low	Low

PNP output type controller

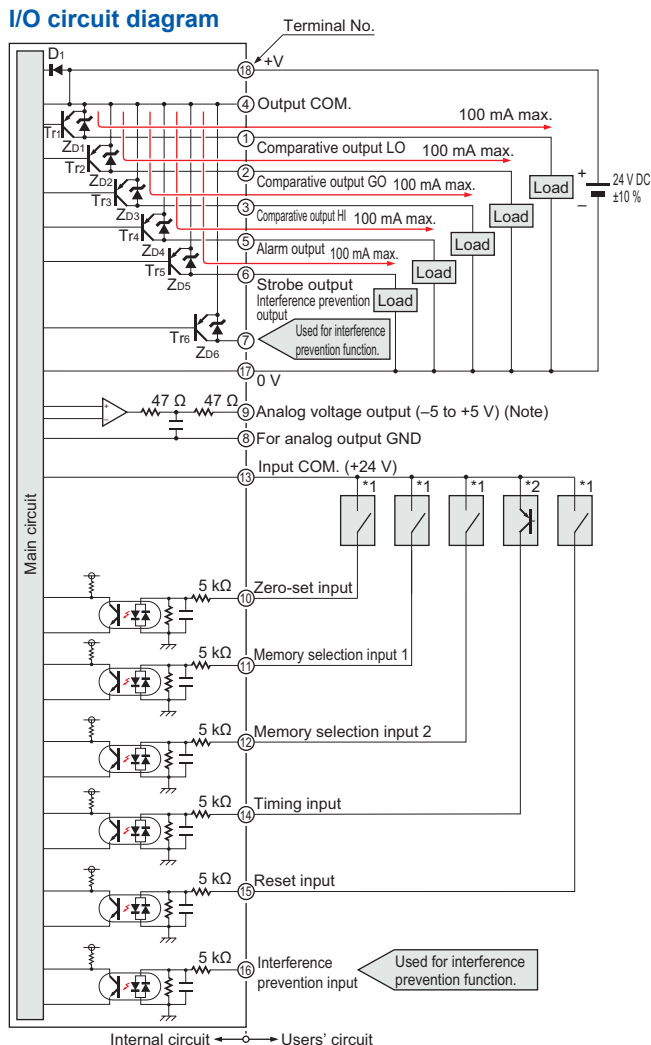

Note: Devices connected to the analog voltage output must have an input impedance set at 1 MΩ or more.

Symbols ... D1: Reverse supply polarity protection diode
ZD1 to ZD6: Surge absorption zener diode
Tr1 to Tr6: PNP output transistor

* 1

Non-voltage contact or PNP open-collector transistor

- Zero-set input, reset input, memory selection input
Low (0 V or open): Ineffective
High (+17 or +24 V): Effective

* 2

PNP open-collector transistor

- Timing input
Low (0 V or open): Ineffective
High (+17 to +24 V): Effective

Memory selection input

Memory No.	Memory selection 1	Memory selection 2
0	Low	Low
1	High	Low
2	Low	High
3	High	High

- Selection Guide
- Laser Displacement
- Magnetic Displacement
- Collimated Beam
- Digital Panel Controller
- Metal-sheet Double-feed Detection

- GP-X
- GP-A

PRECAUTIONS FOR PROPER USE

Refer to p.1501 for general precautions.

FIBER SENSORS

LASER SENSORS

PHOTO-ELECTRIC SENSORS

MICRO PHOTO-ELECTRIC SENSORS

AREA SENSORS

LIGHT CURTAINS / SAFETY COMPONENTS

PRESSURE / FLOW SENSORS

INDUCTIVE PROXIMITY SENSORS

PARTICULAR USE SENSORS

SENSOR OPTIONS

SIMPLE WIRE-SAVING UNITS

WIRE-SAVING SYSTEMS

MEASURE-MENT SENSORS

STATIC ELECTRICITY PREVENTION DEVICES

LASER MARKERS

PLC

HUMAN MACHINE INTERFACES

ENERGY CONSUMPTION VISUALIZATION COMPONENTS

FA COMPONENTS

MACHINE VISION SYSTEMS

UV CURING SYSTEMS

Selection Guide

Laser Displacement

Magnetic Displacement

Collimated Beam

Digital Panel Controller

Metal-sheet Double-feed Detection

GP-X

GP-A



- Never use this product as a sensing device for personnel protection.
- In case of using sensing devices for personnel protection, use products which meet laws and standards, such as OSHA, ANSI or IEC etc., for personnel protection applicable in each region or country.

- The sensor head and the controller are adjusted in order to conform to the default specification linearity.
- In the event of replacing sensor heads, input the sensor head's characteristic code and conduct 3-point correction (calibration).
- Should you use an extension cable, turn the sensor head cable length selection switch located on the back of the controller to "3 m + 7 m 9.843 ft + 22.966 ft". Then reintroduce the power supply and conduct 3-point correction (calibration).

Conditions in use for CE conformity

- This product is CE compliant and complies with EMC directives. EN 61000-6-2 is the applicable standard that covers immunities relating to use of this product, but in order to comply with this standard, the following conditions must be satisfied.

Conditions

- The controller should be connected less than 10 m 32.808 ft from the power supply.
- The signal line to connect with the controller should be less than 30 m 98.425 ft.
- A ferrite clamp must be mounted within 10 mm 0.394 in from connector fitted onto the GP-XBCC3 cable with connector on one end for BCD output units.

Linearity in case of disc-shaped or cylindrical objects

- In case the sensing object is disc-shaped or cylindrical, the linearity varies with the sensing object size. In the event the sensing object is larger than the sizes indicated in the table below, the linearity specification (within ±0.3 % F.S.) is satisfied by performing zero-adjustment and span adjustment when in contact using the scaling function.

<In case of disc>

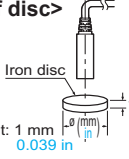

Sensor head	Disc diameter ø (mm in)	Cylinder diameter ø (mm in)
GP-X3SE	6 0.236	16 0.630
GP-X5SE	8 0.315	16 0.630
GP-X8S	12 0.472	50 1.969

<In case of cylinder>

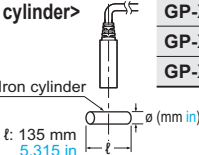

GP-X10M	12 0.472	50 1.969
GP-X12ML	25 0.984	55 2.165
GP-X22KL	30 1.181	165 6.496

Mounting sensor head

- The tightening torque should be under the value given below.

Mounting with set screw

- Make sure to use an M3 or smaller set screw having a cup-point.

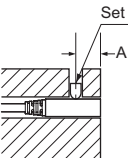

Model No.	A (mm in)	Tightening torque
GP-X3SE	4 to 16 0.157 to 0.630	0.10 N·m or less
GP-X5SE	5 to 16 0.197 to 0.630	0.44 N·m or less
GP-X8S		0.58 N·m or less

Mounting with nut

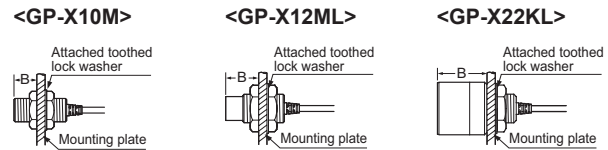

Model No.	B (mm in)	Tightening torque
GP-X10M	7 0.276 or more	9.8 N·m or less
GP-X12ML	14 0.551 or more	20 N·m or less
GP-X22KL	20 0.787 or more (Note 1)	20 N·m or less

Notes: 1) Without nut. If a nut is installed, the dimension will be 23.5 mm 0.926 in or more.
2) Mount such that the nuts do not protrude from the threaded portion.

Distance from surrounding metal

- As metal around the sensor head may affect the sensing performance, pay attention to the following points.

<Embedding of the sensor head in metal>

- Since the analog output may change if the sensor head is completely embedded in metal, keep the minimum distance specified in the table below.

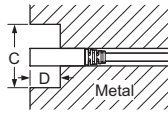

Sensor head	C (mm in)	D (mm in)
GP-X3SE	ø10 ø0.394	3 0.118
GP-X5SE		
GP-X8S		
GP-X10M		
GP-X12ML	ø50 ø1.969	14 0.551
GP-X22KL	ø50 ø1.969	20 0.787

Mutual interference

- If several sensor heads are mounted close together, some specifications may not be satisfied. Therefore, proceed with the interference prevention function enabled. The interference prevention function eliminates interference among sensors by alternating sensor oscillations. Contact our office for details about time charts etc. If not using the interference prevention function, leave a distance more than the values given below.

<Face to face mounting>

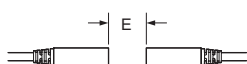

Sensor head	E (mm in)	F (mm in)
GP-X3SE	15 0.591	9 0.354
GP-X5SE	30 1.181	11 0.433
GP-X8S	40 1.575	15 0.591
GP-X10M	40 1.575	15 0.591
GP-X12ML	170 6.693	50 1.969
GP-X22KL	200 7.874	200 7.874

<Parallel mounting>



Sensing range

- The sensing range is specified for the standard sensing object [stainless steel (SUS304) / iron [Cold rolled carbon steel (SPCC)], 60 × 60 × t 1 mm 2.362 × 2.362 × t 0.039 in]. For sensing metals other than the standard sensing objects, use the correction coefficient stated below as a guideline. Verify with the actual sensor before using.

Correction coefficient

Sensor head	GP-X3SE	GP-X5SE	GP-X8S
Metal	GP-X10M	GP-X12ML	GP-X22KL
Stainless steel (SUS304), Iron	1		
Aluminum	0.5 approx.		

Others

- After turning on the power, wait 15 min. or more [20 min. for the GP-XC3SE(-P) and GP-XC5SE(-P)] before using the product. The power supply circuit is not stable immediately after the power is turned on, and this may cause measurement values to be distorted. In addition, note that there will also be a muting period of approx. 2 sec.

DIMENSIONS (Unit: mm in)

The CAD data in the dimensions can be downloaded from our website.

Controller

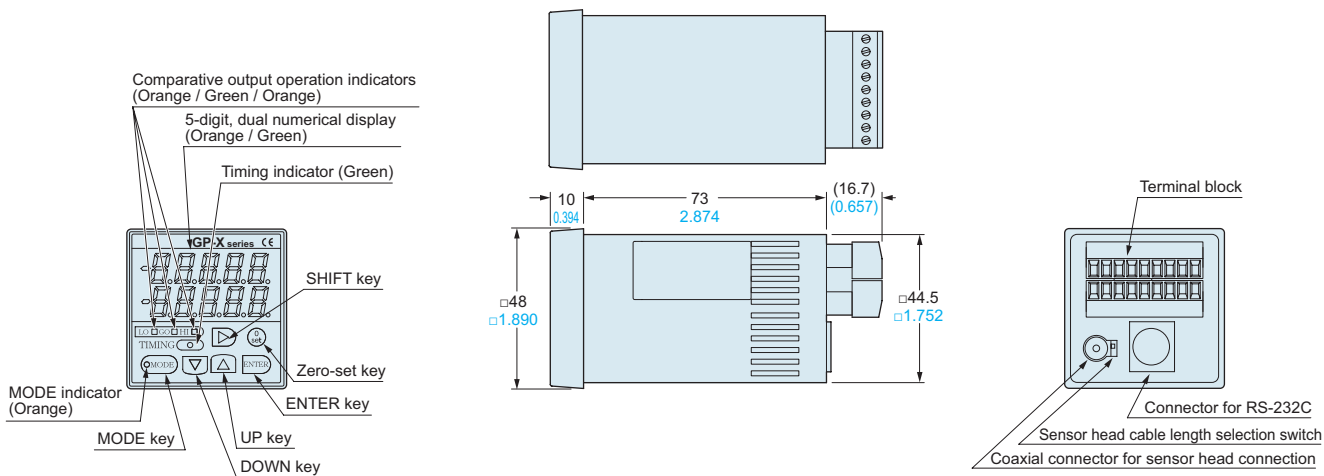

Panel cut-out dimensions

<When BCD output unit / controller communication unit not mounted>

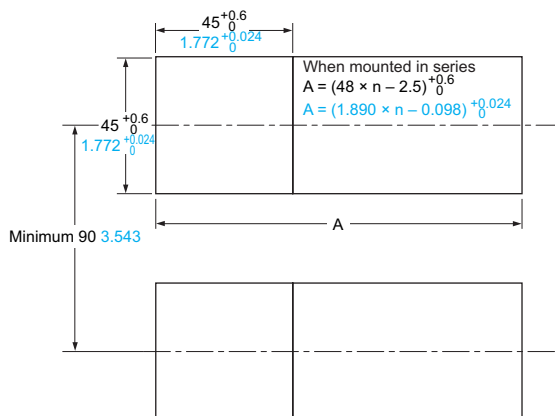

Note: The panel thickness should be 1 to 5 mm 0.039 to 0.197 in.

<When BCD output unit / controller communication unit mounted>

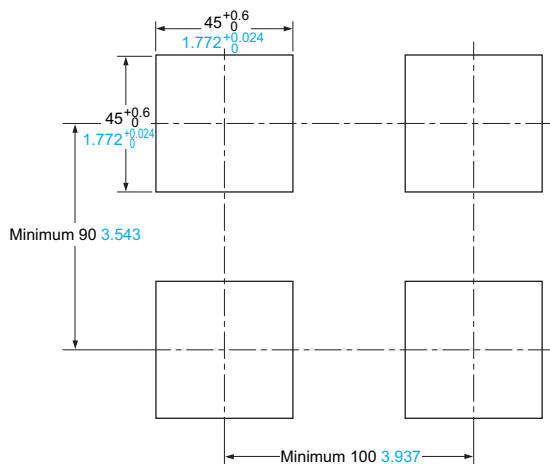

Note: The panel thickness should be 1 to 2.5 mm 0.039 to 0.098 in.

GP-X3SE

Sensor head

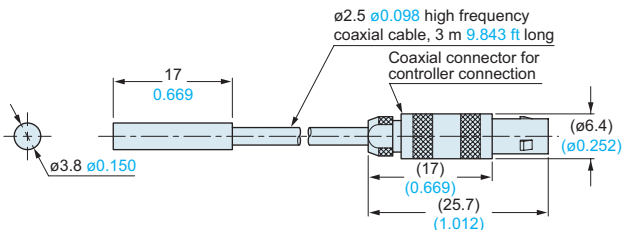

GP-X5SE

Sensor head

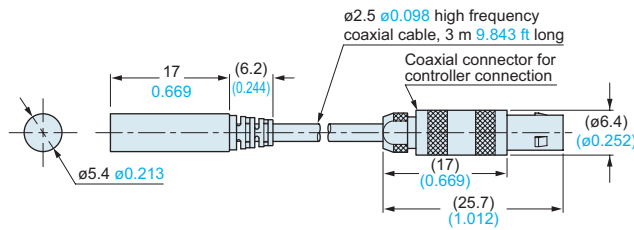

GP-X8S

Sensor head

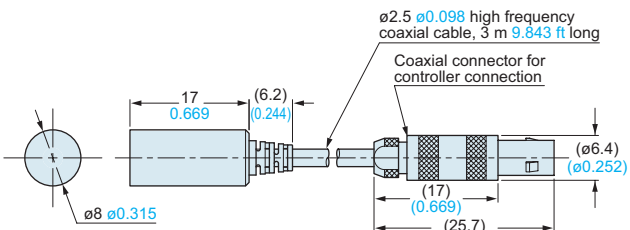

GP-X10M

Sensor head

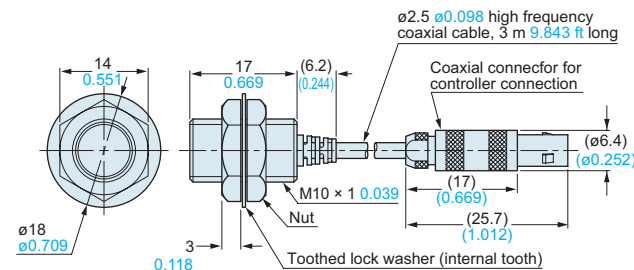

DIMENSIONS (Unit: mm in)

The CAD data in the dimensions can be downloaded from our website.

GP-X12ML Sensor head

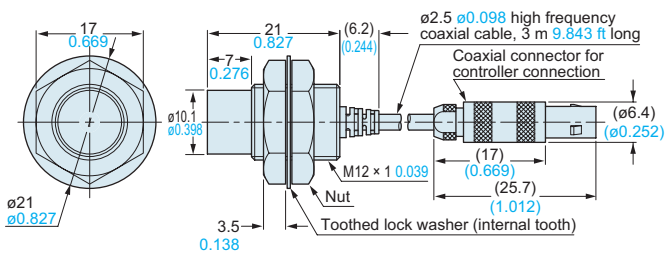

GP-X22KL Sensor head

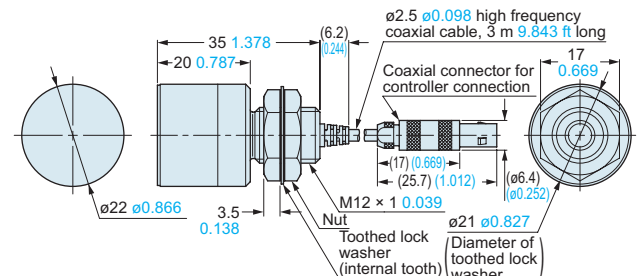

GP-XBCD BCD output unit (Optional)

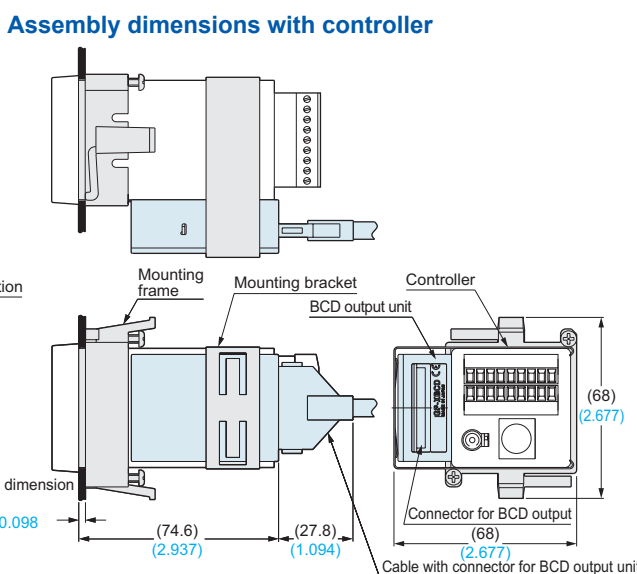
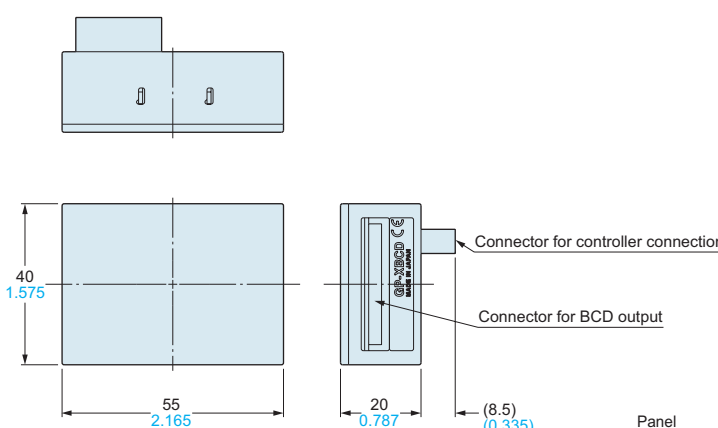

GP-XCOM Controller communication unit (Optional)

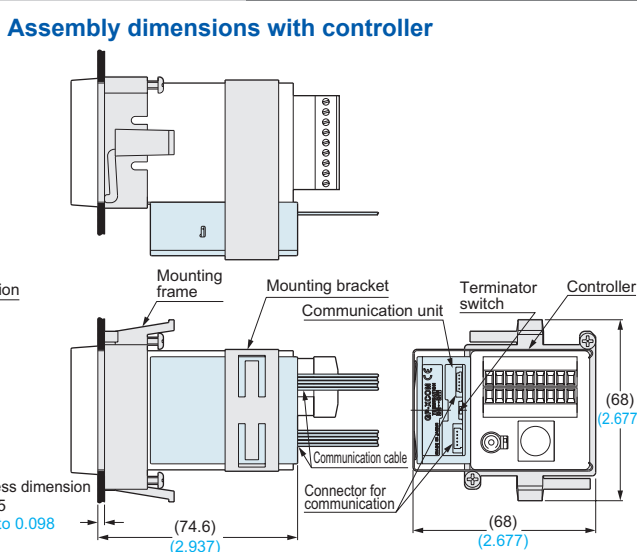
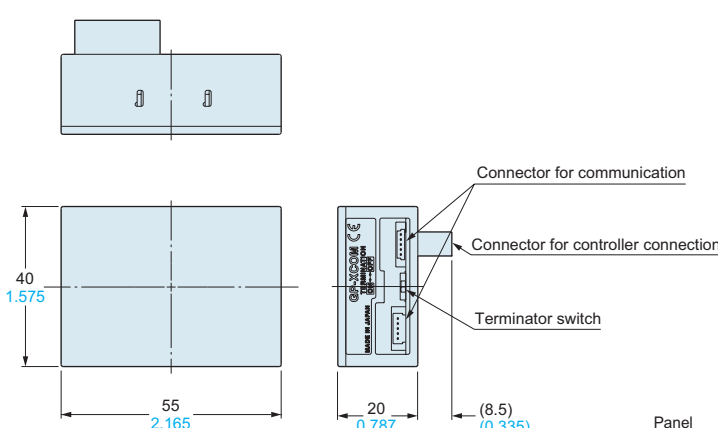

MS-SS3 MS-SS5 MS-SS8 Sensor head mounting bracket (Optional)

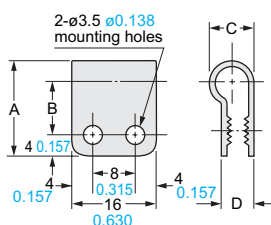

Material: Nylon 66

Symbol	Model No.	MS-SS3	MS-SS5	MS-SS8
A		16 0.630	18 0.709	20 0.787
B		9 0.354	10 0.394	11 0.433
C		6.3 0.248	8.3 0.327	10.3 0.406
D		4.9 0.193	6.1 0.240	6.5 0.256
Applicable sensor head model No.		GP-X3SE	GP-X5SE	GP-X8S

- FIBER SENSORS
- LASER SENSORS
- PHOTO-ELECTRIC SENSORS
- MICRO PHOTO-ELECTRIC SENSORS
- AREA SENSORS
- LIGHT CURTAINS / SAFETY COMPONENTS
- PRESSURE / FLOW SENSORS
- INDUCTIVE PROXIMITY SENSORS
- PARTICULAR USE SENSORS
- SENSOR OPTIONS
- WIRE-SAVING UNITS
- WIRE-SAVING SYSTEMS
- MEASUREMENT SENSORS
- STATIC ELECTRICITY PREVENTION DEVICES
- LASER MARKERS
- PLC
- HUMAN MACHINE INTERFACES
- ENERGY CONSUMPTION VISUALIZATION COMPONENTS
- FA COMPONENTS
- MACHINE VISION SYSTEMS
- UV CURING SYSTEMS
- Selection Guide
- Laser Displacement
- Magnetic Displacement
- Collimated Beam
- Digital Panel Controller
- Metal-sheet Double-feed Detection
- GP-X**
- GP-A**