



Chipsmall Limited consists of a professional team with an average of over 10 year of expertise in the distribution of electronic components. Based in Hongkong, we have already established firm and mutual-benefit business relationships with customers from,Europe,America and south Asia,supplying obsolete and hard-to-find components to meet their specific needs.

With the principle of "Quality Parts,Customers Priority,Honest Operation,and Considerate Service",our business mainly focus on the distribution of electronic components. Line cards we deal with include Microchip,ALPS,ROHM,Xilinx,Pulse,ON,Everlight and Freescale. Main products comprise IC,Modules,Potentiometer,IC Socket,Relay,Connector.Our parts cover such applications as commercial,industrial, and automotives areas.

We are looking forward to setting up business relationship with you and hope to provide you with the best service and solution. Let us make a better world for our industry!



Contact us

Tel: +86-755-8981 8866 Fax: +86-755-8427 6832

Email & Skype: info@chipsmall.com Web: www.chipsmall.com

Address: A1208, Overseas Decoration Building, #122 Zhenhua RD., Futian, Shenzhen, China



GP1A173LCSVF

Gap : 5.0mm Slit : 0.5mm
*OPIC Output, Snap-in type
Compact Transmissive
Photointerrupter with connector

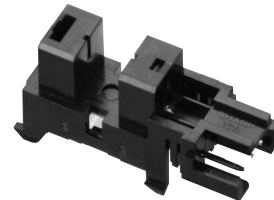

■Description

GP1A173LCSVF is a standard, OPIC output, transmissive photointerrupter with opposing emitter and detector in a case, providing non-contact sensing. For this family of devices, the emitter and detector are inserted in a case, and a 3-pin connector is included to allow remote-mount or off-board designs.

■Agency approvals/Compliance

1. Compliant with RoHS directive (2002/95/EC)

■Applications

1. General purpose detection of object presence or motion.
Example : PPC, FAX, Printer

■Features

1. Transmissive with OPIC output
2. Highlights :
 - Special position hooks compatible with 3 different Plate thicknesses (1.0, 1.2, 1.6mm)
 - Snap insertion
3. Key Parameters :
 - Gap Width : 5mm
 - Slit Width (detector side) : 0.5mm
 - Package : 17 × 12.8 × 8mm (without connector and hooks)
 - Connector : Tyco Electronics JAPAN G.K. (173977-3 and 179228-3)
4. RoHS directive compliant

*"OPIC"(Optical IC) is a trademark of the SHARP Corporation. An OPIC consists of a light-detecting element and a signal-processing

Notice The content of data sheet is subject to change without prior notice.
In the absence of confirmation by device specification sheets, SHARP takes no responsibility for any defects that may occur in equipment using any SHARP devices shown in catalogs, data books, etc. Contact SHARP in order to obtain the latest device specification sheets before using any SHARP device.

Sheet No.: OP13032EN

■ Internal Connection Diagram

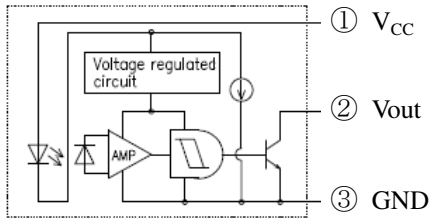

■ Outline

Drawing No. CY15074i02

Scale : 2/1 Unit : 1/1 mm

- Note) 1. Unspecified tolerance shall be followed the list below.
 2. Dimensions in parenthesis are shown for reference.
 3. Coupling and contact : CT receptacle connector (173977-3 and 179228-3) by Tyco Electronics Japan G.K.
 4. Date code
 Y : Year (2012 : 2) Number of the end of the Christian era
 M : Month (1-9, X, Y, Z)
 D : Date (1-9, Please refer to a right list other than it.)

Date	10	11	12	13	14
Code	A	B	C	D	E
Date	15	16	17	18	19
Code	F	G	H	J	K
Date	20	21	22	23	24
Code	M	N	O	P	R
Date	25	26	27	28	29
Code	S	T	U	W	X
Date	30	31			
Code	Y	Z			

Dimension	Tolerance
less than 5.0	±0.15
5.0 or more, less than 15.0	±0.2
15.0 or more	±0.3

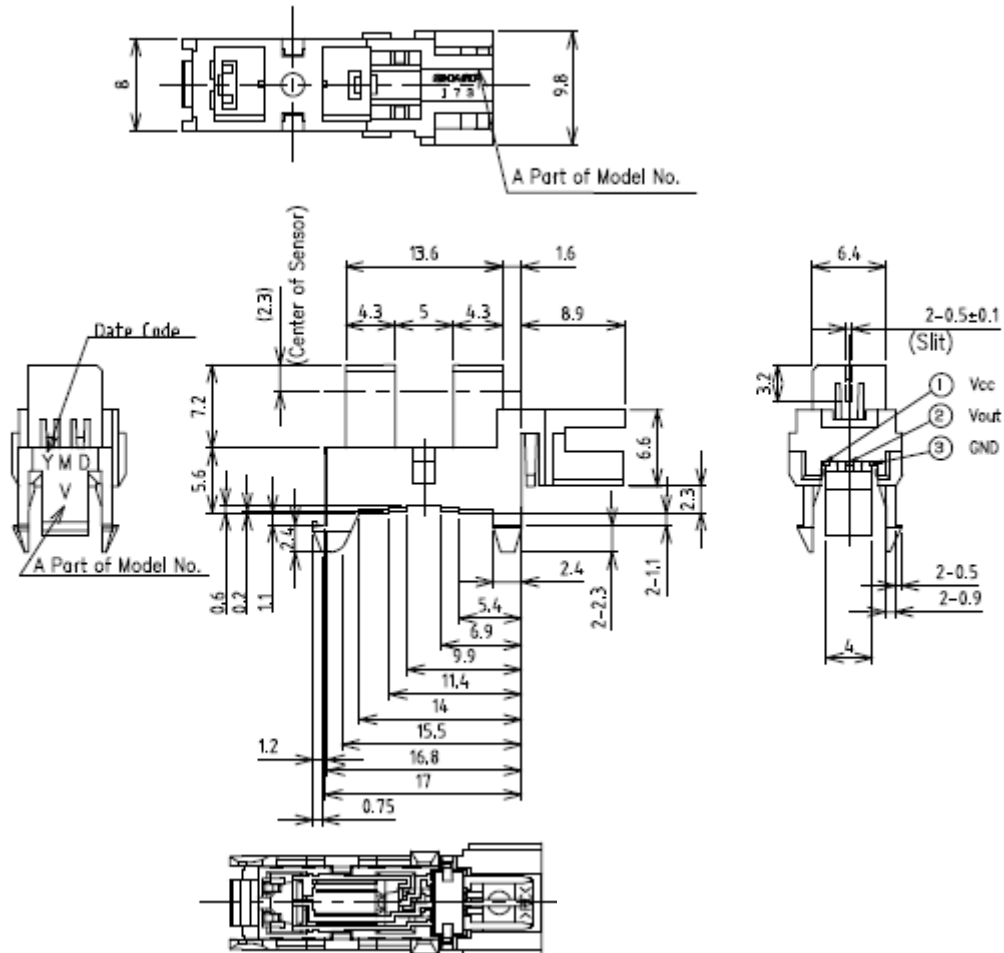

■ Absolute maximum ratings

Ta=25°C

Parameter	Symbol	Rating	Unit	Remark
Supply voltage	V _{CC}	-0.5 to +6	V	
Output voltage	V _{out}	-0.5 to +6	V	Output transistor between collector and emitter
Output current	I _{OL}	8	mA	Output transistor collector current *1
Operating temperature	T _{opr}	-30 to +95	°C	The connector should be plugged in/out at normal temperature.
Storage temperature	T _{stg}	-40 to +100	°C	

*1 Fig.1 shows output current vs. ambient temperature.

■ Electro-optical Characteristics

V_{CC}=5V, Ta=25°C

Parameter	Symbol	Rating	Unit	Conditions
Current dissipation	I _{CCL}	20 MAX	mA	Light beam uninterrupted
Low level output voltage	V _{OL}	0.35 MAX	V	Light beam uninterrupted I _{OL} =4mA
Current dissipation	I _{CCH}	20 MAX	mA	Light beam interrupted
High level output voltage	V _{OH}	V _{CC} ×0.9 MIN	V	Light beam interrupted R _L =47kΩ
Operating voltage	V _{CC}	4.5 to 5.5	V	
Response characteristics	Min. interrupted time	t _H	166 MIN	μs R _L =4.7kΩ
	Min. uninterrupted time	t _L	166 MIN	

■ Detection position characteristics

Ta=25°C, V_{CC}=5V, R_L=47kΩ

Horizontal detecting position characteristics
(d = 3.2±0.3mm)

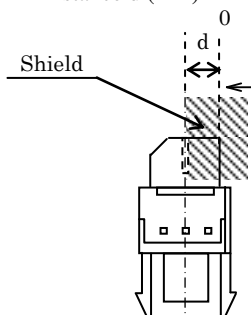
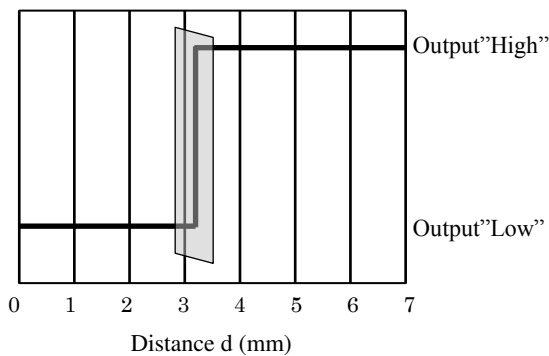

Vertical detecting position characteristics
(d = 3.0 +0.3 mm)
-1.8

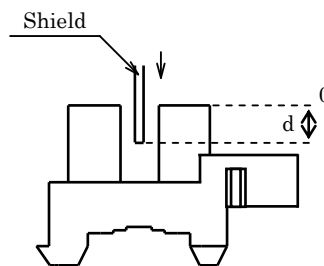
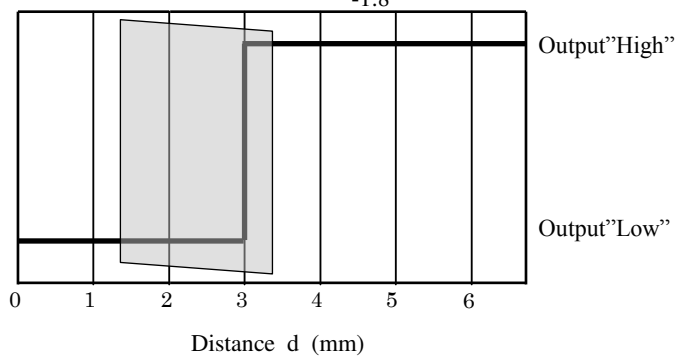
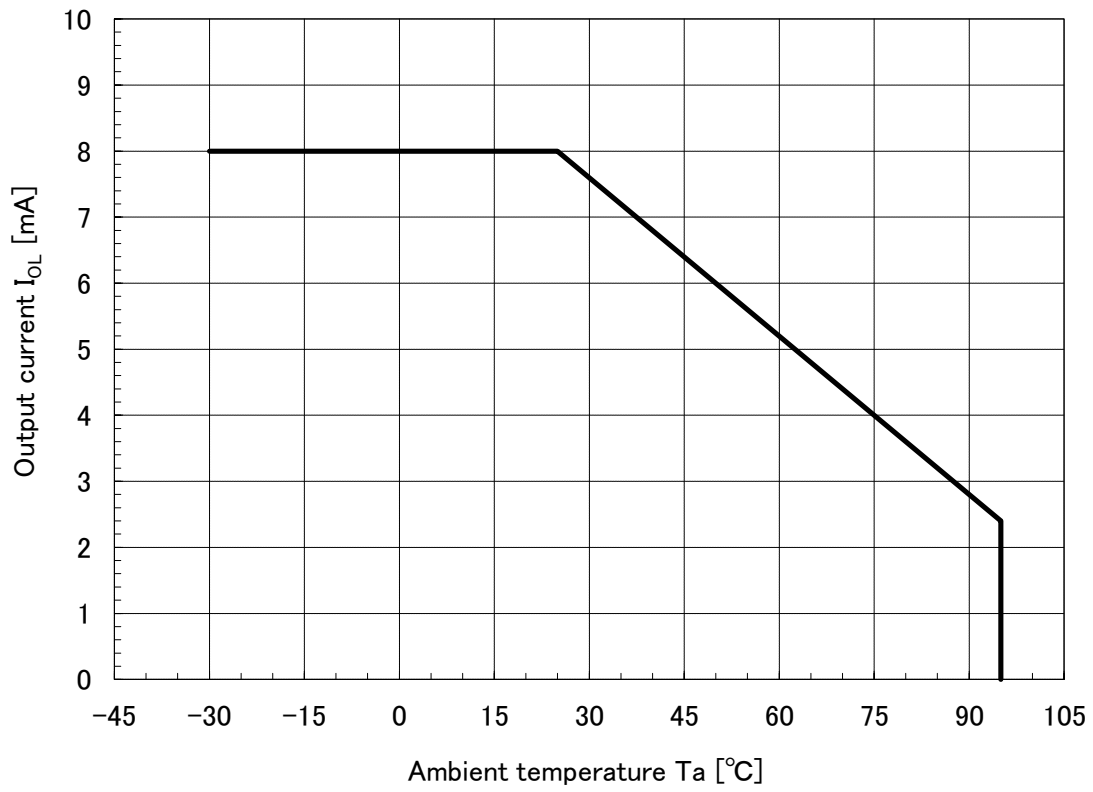

Fig.1 Output current vs. ambient temperature



■ **Supplements**

● ODS materials

This product shall not contain the following materials.

Also, the following materials shall not be used in the production process for this product.

Materials for ODS : CFCs, Halon, Carbon tetrachloride 1.1.1-Trichloroethane (Methyl chloroform)

● Specified brominated flame retardants

Specified brominated flame retardants (PBB and PBDE) are not used in this device at all.

● Compliance with each regulation

1) The RoHS directive(2002/95/EC)

This product complies with the RoHS directive(2002/95/EC).

Object substances: mercury, lead, cadmium, hexavalent chromium, polybrominated biphenyls (PBB) and polybrominated diphenyl ethers (PBDE)

2) Content of six substances specified in Management Methods for Control of Pollution Caused by Electronic Information Products Regulation (Chinese : 电子信息产品污染控制管理办法).

Category	Toxic and hazardous substances					
	Lead (Pb)	Mercury (Hg)	Cadmium (Cd)	Hexavalent chromium (Cr ⁶⁺)	Polybrominated biphenyls (PBB)	Polybrominated diphenyl ethers (PBDE)
Photointerrupter	✓	✓	✓	✓	✓	✓

✓ : indicates that the content of the toxic and hazardous substance in all the homogeneous materials of the part is below the concentration limit requirement as described in SJ/T 11363-2006 standard.

● Product mass : Approx. 1.0g

● Country of origin : Phillipine or China

■Notes

- Truth Table (In case of external addition pull-up resistance to Vout terminal)

Light beam	Output
Interrupted	High
Uninterrupted	Low

- Power supply line

In order to stabilize power supply line, connect a by-pass capacitor of more than $0.01\mu\text{F}$ between V_{CC} and GND near the device.

- Opaque board

Opaque board shall be installed at place 4mm or more from the top of elements.

(Example)

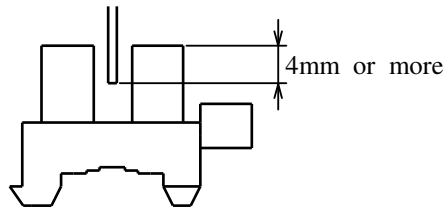

In case opaque board is the material with an low light blocking effect, There is a possibility of malfunctioning because the light of LED transmits the opaque board. When you design the opaque board, please note transmittance of infrared rays wave length (950nm) and the thickness of the opaque board.

And, please adjust the amount of transmitted light to 0.1% or less.

- Cleaning

Please don't carry out immersion cleaning or ultrasonic cleaning to avoid keeping solvent inside case of this device.

- Washing material

Dust and stain shall clean by air blow, or shall clean by soft cloth soaked in washing materials.

And washing material to clean shall be used the below materials only.

Ethyl alcohol, Methyl alcohol, Isopropyl alcohol

- Connector connection

For the electrical connection to the connector terminal, please certainly use the connector specified in this specifications.

Please avoid the connection by the soldering or welding which may damage the main body of the device, and also avoid the contact by the clip and so on which may cause the malfunction by the contact failure.

Please avoid the use condition that it always occurs the vibration in the spot where the connector fits in by the resonance of the sensor and the harness.

It may cause the malfunction of the contact failure.

- Put-in and pull-out of connector

The connection other than to the correct connection direction, forcing-into, and the pulling-out diagonally (if being not put-in and pulled-out straight) may deform or break the connector terminal and/or housing, which may cause the unusable state of the device.

■ **Recommended Installation Hole drawing**

Scale : 2/1 Unit : 1/1mm

(Drawing No. CY15075i06)

- *1 We recommend to fix GP1A173LCSVF at punching side on the fixing plate (metal plate).
- *2 Please decide the final dimensions at your side after confirmation by the actual applications, Because mounting efficiency and mounted stabilization are dependent on mounting plate corner-R and punched state.
- *3 Tolerance shall be ± 0.1 mm
- *4 Please don't hold connector area but sensor area when fitting in or putting out on the metal plate.

Normal mounting type

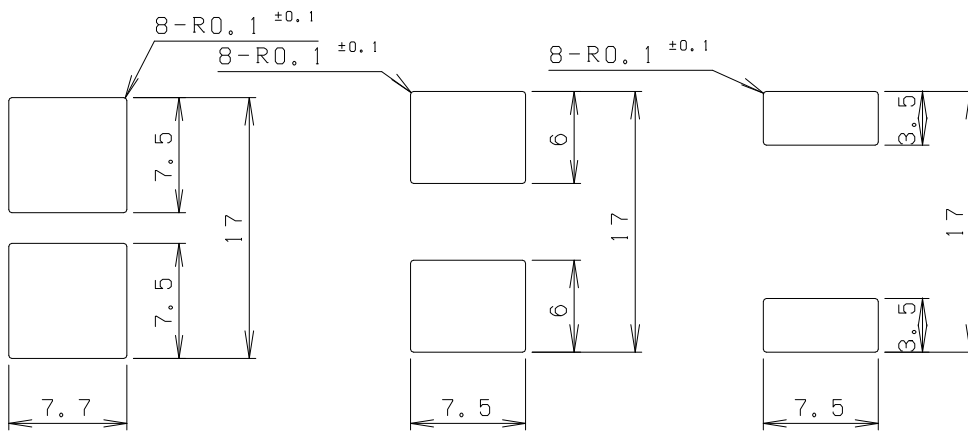

Thickness of plate for 1.6mm

Thickness of plate for 1.2mm

Thickness of plate for 1.0mm

Irregular mounting protection type

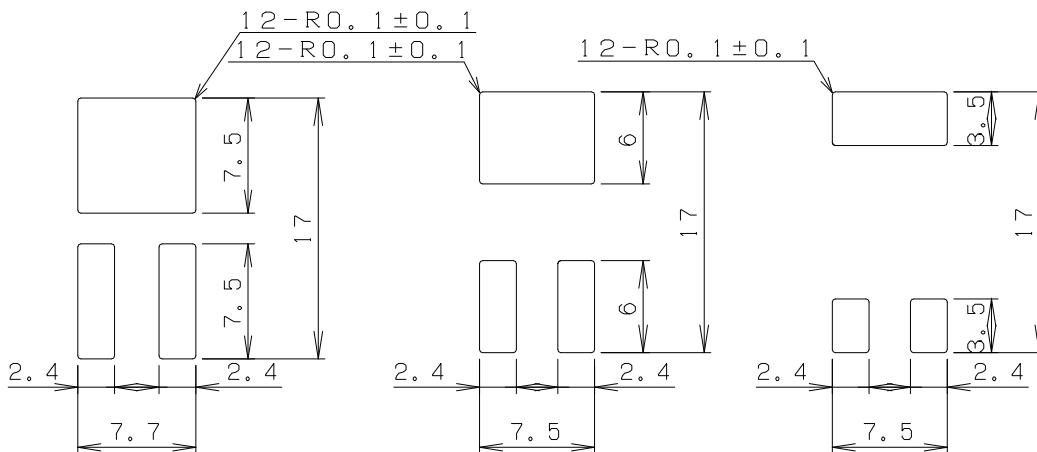

Thickness of plate for 1.6mm

Thickness of plate for 1.2mm

Thickness of plate for 1.0mm

■Parts

This product uses the below parts.

- Light detector (Quantity : 1)
(Using a silicon photodiode as light detecting portion, and a bipolar IC as signal processing circuit.)

Type	Maximum sensitivity wavelength (nm)	Sensitivity wavelength (nm)	Response time (μs)
Photodiode	900	400 to 1200	10

- Light emitter (Quantity : 1)

Type	Material	Maximum light emitting wavelength (nm)	I/O Frequency (MHz)
Infrared light emitting diode (non-coherent)	GaAs	950	0.3

- Material

Case	Lead flame
Black polycarbonate resin (UL 94V-0)	Copper Alloy (With plating)

- Others

This product shall not be radiation flux proof.
The laser oscillator is not equipped on this product.
The terminals are covered with Tin Plating (more than 99.99%).

■ Packing specification

● Package

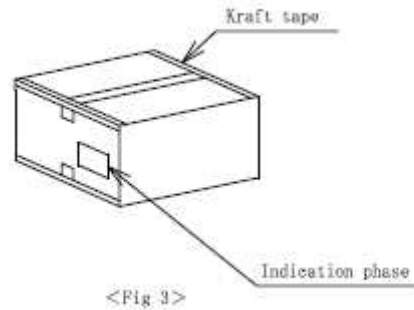
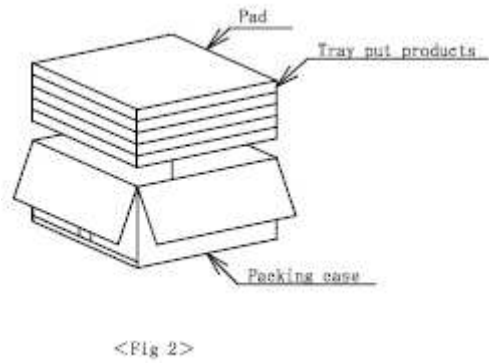
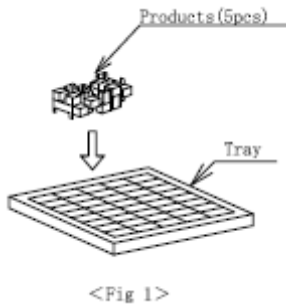

No.	Name	Material	Quantity
1	Packing case	Corrugated cardboard	1/1000
2	Pad	Corrugated cardboard	6/1000
3	Tray	Polystyrene	1/200
4	Kraft tape	-	-

● Packing method

- 1) 5 products are put in 1 pocket.

The longer direction of the product is arranged in the arbitrary direction.

200 products are put in the tray. <Fig.1>

- 2) The pads are attached at the top and the bottom of the trays and also inserted between the trays. <Fig.2>

- 3) Seal packing case with Kraft tape. <Fig.3>

- 4) Indication items

The contents of the carton indication conforms to EIAJ C-3 and the following items are indicated.

Model No., Internal production control name, Quantity, Packing date, Corporate name,

Country of origin <Fig.3>

(1000pcs. / packing case)

(Approximately 2.26kg / packing mass)

■ Important Notices

· The circuit application examples in this publication are provided to explain representative applications of SHARP devices and are not intended to guarantee any circuit design or license any intellectual property rights. SHARP takes no responsibility for any problems related to any intellectual property right of a third party resulting from the use of SHARP's devices.

· Contact SHARP in order to obtain the latest device specification sheets before using any SHARP device. SHARP reserves the right to make changes in the specifications, characteristics, data, materials, structure, and other contents described herein at any time without notice in order to improve design or reliability. Manufacturing locations are also subject to change without notice.

· Observe the following points when using any devices in this publication. SHARP takes no responsibility for damage caused by improper use of the devices which does not meet the conditions and absolute maximum ratings to be used specified in the relevant specification sheet nor meet the following conditions:

(i) The devices in this publication are designed for use in general electronic equipment designs such as:

- Personal computers
- Office automation equipment
- Telecommunication equipment [terminal]
- Test and measurement equipment
- Industrial control
- Audio visual equipment
- Consumer electronics

(ii) Measures such as fail-safe function and redundant design should be taken to ensure reliability and safety when SHARP devices are used for or in connection

with equipment that requires higher reliability such as:

- Transportation control and safety equipment (i.e., aircraft, trains, automobiles, etc.)
- Traffic signals
- Gas leakage sensor breakers
- Alarm equipment
- Various safety devices, etc.

(iii) SHARP devices shall not be used for or in connection with equipment that requires an extremely high level of reliability and safety such as:

- Space applications
- Telecommunication equipment [trunk lines]
- Nuclear power control equipment
- Medical and other life support equipment (e.g., scuba).

· If the SHARP devices listed in this publication fall within the scope of strategic products described in the Foreign Exchange and Foreign Trade Law of Japan, it is necessary to obtain approval to export such SHARP devices.

· This publication is the proprietary product of SHARP and is copyrighted, with all rights reserved. Under the copyright laws, no part of this publication may be reproduced or transmitted in any form or by any means, electronic or mechanical, for any purpose, in whole or in part, without the express written permission of SHARP. Express written permission is also required before any use of this publication may be made by a third party.

· Contact and consult with a SHARP representative if there are any questions about the contents of this publication.