



Chipsmall Limited consists of a professional team with an average of over 10 year of expertise in the distribution of electronic components. Based in Hongkong, we have already established firm and mutual-benefit business relationships with customers from,Europe,America and south Asia,supplying obsolete and hard-to-find components to meet their specific needs.

With the principle of "Quality Parts,Customers Priority,Honest Operation,and Considerate Service",our business mainly focus on the distribution of electronic components. Line cards we deal with include Microchip,ALPS,ROHM,Xilinx,Pulse,ON,Everlight and Freescale. Main products comprise IC,Modules,Potentiometer,IC Socket,Relay,Connector.Our parts cover such applications as commercial,industrial, and automotives areas.

We are looking forward to setting up business relationship with you and hope to provide you with the best service and solution. Let us make a better world for our industry!



## Contact us

Tel: +86-755-8981 8866 Fax: +86-755-8427 6832

Email & Skype: info@chipsmall.com Web: www.chipsmall.com

Address: A1208, Overseas Decoration Building, #122 Zhenhua RD., Futian, Shenzhen, China



# GP1A51HRJ00F

Gap : 3mm, Slit : 0.5mm  
 \*OPIC Output  
 Case package Transmissive  
 Photointerrupter



## ■ Description

**GP1A51HRJ00F** is a standard, OPIC output, transmissive photointerrupter with opposing emitter and detector in a case, providing non-contact sensing. For this family of devices, the emitter and detector are inserted in a case, resulting in a through-hole design.

The case includes additional screw fixing holes, on both sides 3.2mm diameter.

## ■ Features

1. Transmissive with OPIC output
2. Highlights:
  - Vertical Slit for alternate motion detection
  - Output Low Level at intercepting optical path
  - Includes additional screw fixing holes
3. Key Parameters:
  - Gap Width : 3mm
  - Slit Width (detector side) : 0.5mm
  - Package : 12.2×10×18mm
4. RoHS directive compliant

## ■ Agency approvals/Compliance

1. Compliant with RoHS directive

## ■ Applications

1. General purpose detection of object presence or motion.
2. Example : Printer, FAX, Optical storage unit

\* "OPIC"(Optical IC) is a trademark of the SHARP Corporation. An OPIC consists of a light-detecting element and a signal-processing

Notice The content of data sheet is subject to change without prior notice.  
 In the absence of confirmation by device specification sheets, SHARP takes no responsibility for any defects that may occur in equipment using any SHARP devices shown in catalogs, data books, etc. Contact SHARP in order to obtain the latest device specification sheets before using any SHARP device.

**Internal Connection Diagram**

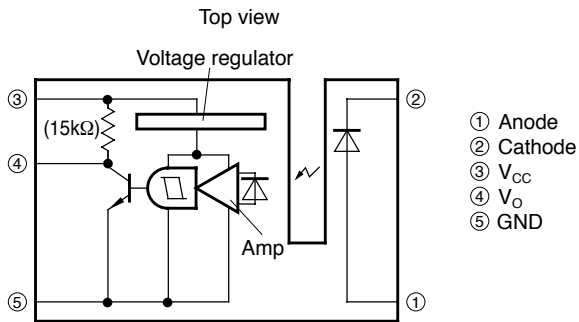

**Outline Dimensions**

(Unit : mm)

Top view

12.2<sup>+0.3</sup>

2

3<sup>+0.2</sup><sub>-0.1</sub>

A-A' section

0.5

3.5

(Detector center)

A, B

Model No.

Date code

7.5

1.5

(9.2)

B-B' section

0.5

1.5

5

2-φ3.2<sup>+0.2</sup>

7

6

10

5-0.45<sup>+0.3</sup><sub>-0.1</sub> g<sub>MIN.</sub>

2-(1.27)

12

18

• Unspecified tolerance shall be as follows ;

Dimensions (d)	Tolerance
d ≤ 6	±0.1
6 < d ≤ 18	±0.2

• ( ) : Reference dimensions

Product mass : approx. 0.65g

Dip soldering material : Sn-3Ag-0.5Cu

**Date code (2 digit)**

1st digit		2nd digit	
Year of production		Month of production	
A.D.	Mark	Month	Mark
2000	0	1	1
2001	1	2	2
2002	2	3	3
2003	3	4	4
2004	4	5	5
2005	5	6	6
2006	6	7	7
2007	7	8	8
2008	8	9	9
2009	9	10	X
2010	0	11	Y
:	:	12	Z

repeats in a 10 year cycle

**Country of origin**

Japan, Indonesia or Philippines  
(Indicated on the packing case)

## ■ Absolute Maximum Ratings (T<sub>a</sub>=25°C)

	Parameter	Symbol	Rating	Unit
Input	*1 Forward current	I <sub>F</sub>	50	mA
	*1, 2 Peak forward current	I <sub>FM</sub>	1	A
	Reverse voltage	V <sub>R</sub>	6	V
	Power dissipation	P	75	mW
Output	Supply voltage	V <sub>CC</sub>	-0.5 to +17	V
	Output current	I <sub>O</sub>	50	mA
	Power dissipation	P <sub>O</sub>	250	mW
	Operating temperature	T <sub>opr</sub>	-25 to +85	°C
	Storage temperature	T <sub>stg</sub>	-40 to +100	°C
	*3 Soldering temperature	T <sub>sol</sub>	260	°C

\*1 The derating factors of absolute maximum ratings due to ambient temperature are shown in Fig. 1, 2, 3

\*2 Pulse width ≤ 100μs, Duty ratio=0.01

\*3 For 5s or less

## ■ Electro-optical Characteristics (T<sub>a</sub>=25°C)

	Parameter	Symbol	Condition	MIN.	TYP.	MAX.	Unit	
Input	Forward voltage	V <sub>F</sub>	I <sub>F</sub> =5mA	-	1.1	1.4	V	
	Reverse current	I <sub>R</sub>	V <sub>R</sub> =3V	-	-	10	μA	
Output	Operating supply voltage	V <sub>CC</sub>	-	4.5	-	17	V	
	Low level output voltage	V <sub>OL</sub>	V <sub>CC</sub> =5V, I <sub>OL</sub> =16mA, I <sub>F</sub> =0	-	0.15	0.4	V	
	High level output voltage	V <sub>OH</sub>	V <sub>CC</sub> =5V, I <sub>F</sub> =5mA	4.9	-	-	V	
	Low level supply current	I <sub>CCL</sub>	V <sub>CC</sub> =5V, I <sub>F</sub> =0	-	1.7	3.8	mA	
	High level supply current	I <sub>CCH</sub>	V <sub>CC</sub> =5V, I <sub>F</sub> =5mA	-	0.7	2.2	mA	
Transfer characteristics	*4 "Low→High" threshold input current	I <sub>FLH</sub>	V <sub>CC</sub> =5V	-	1	5	mA	
	*5 Hysteresis	I <sub>FHL</sub> /I <sub>FLH</sub>	V <sub>CC</sub> =5V	0.55	0.75	0.95	-	
	*6 Response time	"Low→High" Propagation delay time	t <sub>PLH</sub>	V <sub>CC</sub> =5V, I <sub>F</sub> =5mA, R <sub>L</sub> =280Ω	-	3	9	μs
		"High→Low" Propagation delay time	t <sub>PHL</sub>		-	5	15	
		Rise time	t <sub>r</sub>		-	0.1	0.5	
		Fall time	t <sub>f</sub>		-	0.05	0.5	

\*4 I<sub>FLH</sub> represents forward current when output goes from "Low" to "High".

\*5 I<sub>FHL</sub> represents forward current when output goes from "High" to "Low".

\*6 Test circuit for response time is shown in Fig.12.

**Fig.1 Forward Current vs. Ambient Temperature**

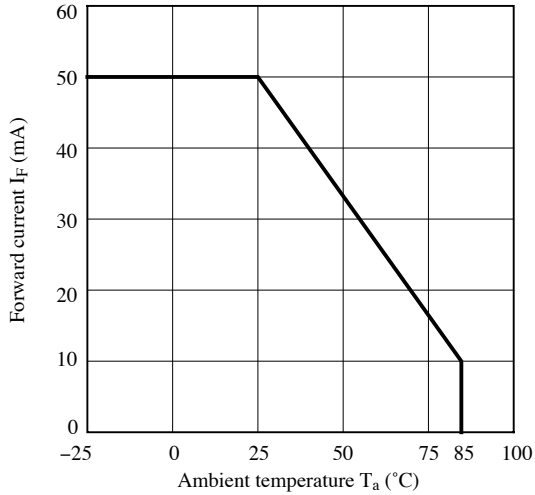

**Fig.2 Output Power Dissipation vs. Ambient Temperature**

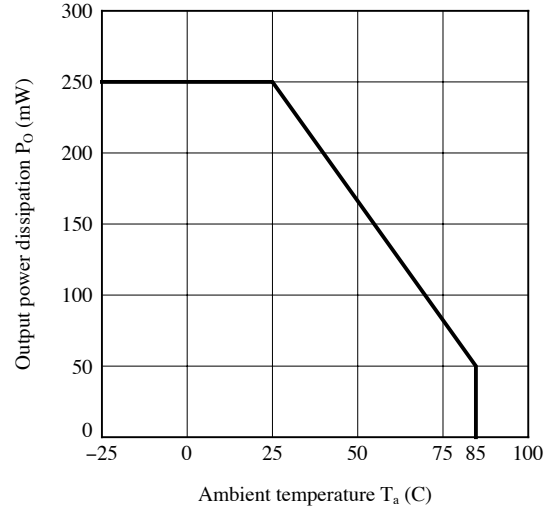

**Fig.3 Low Level Output Current vs. Ambient Temperature**

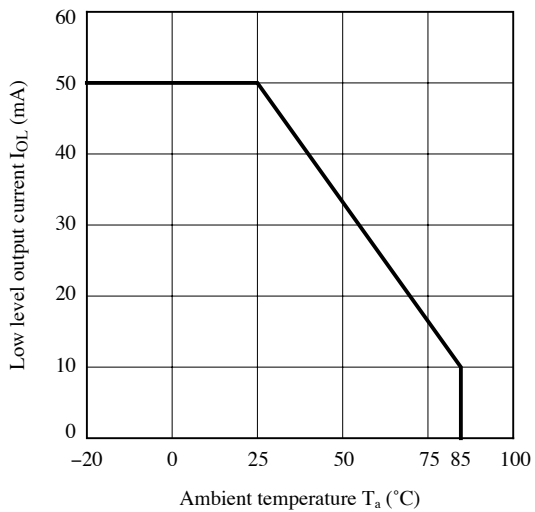

**Fig.4 Forward Current vs. Forward Voltage**

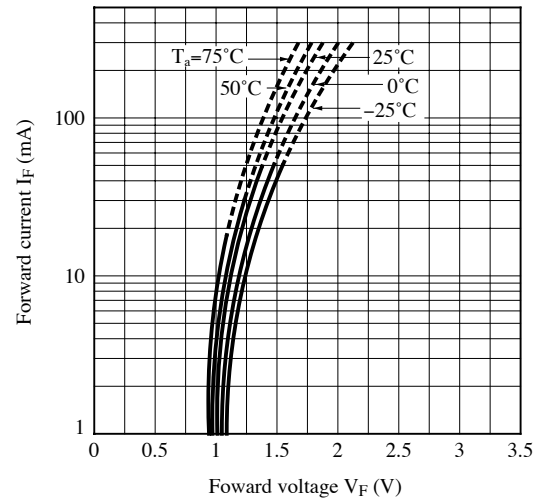

**Fig.5 Relative Threshold Input Current vs. Supply Voltage**

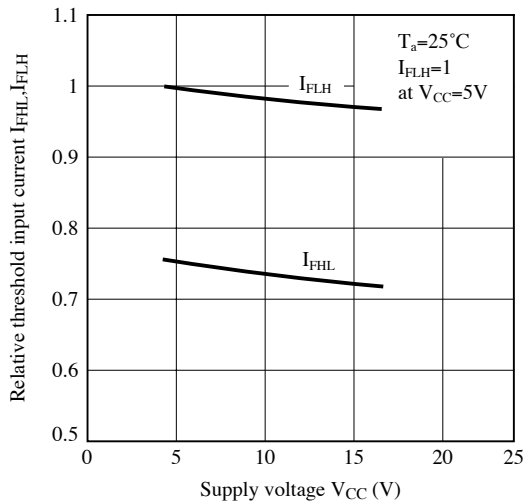

**Fig.6 Relative Threshold Input Current vs. Ambient Temperature**

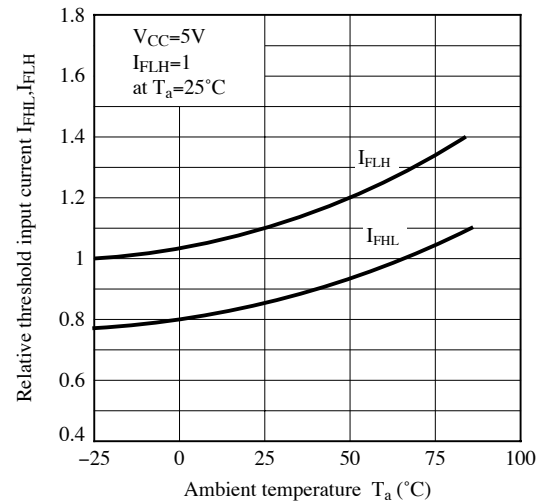

**Fig.7 Low Level Output Voltage vs. Low Level Output Current**

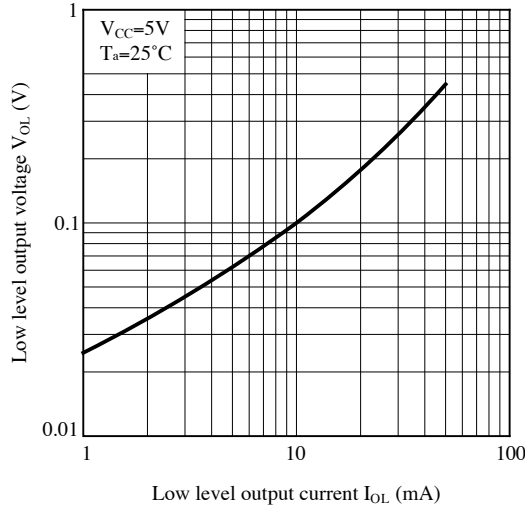

**Fig.8 Low Level Output Voltage vs. Ambient Temperature**

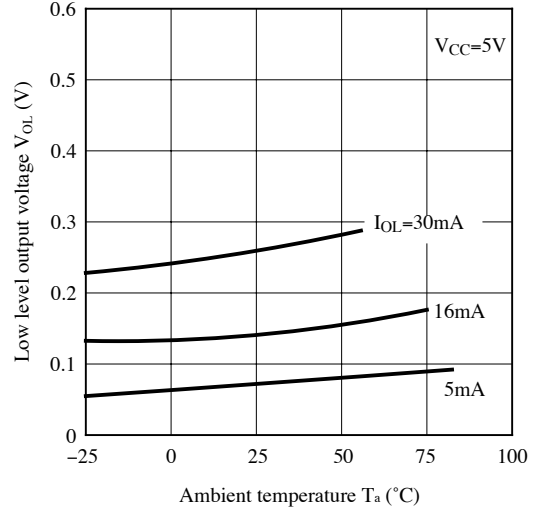

**Fig.9 Supply Current vs. Ambient Temperature**

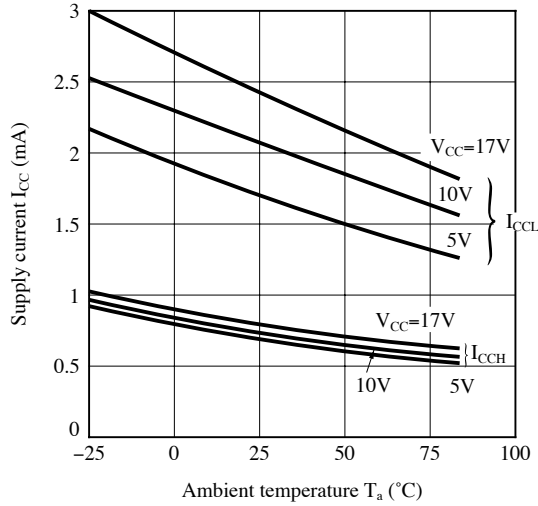

**Fig.10 Propagation Delay Time vs. Forward Current**

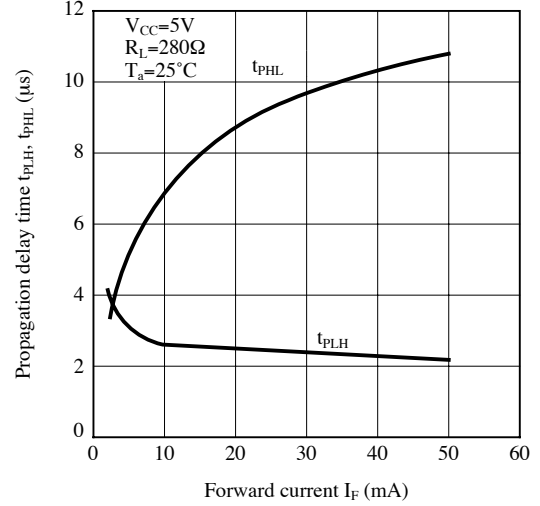

**Fig.11 Rise Time, Fall Time vs. Load Resistance**

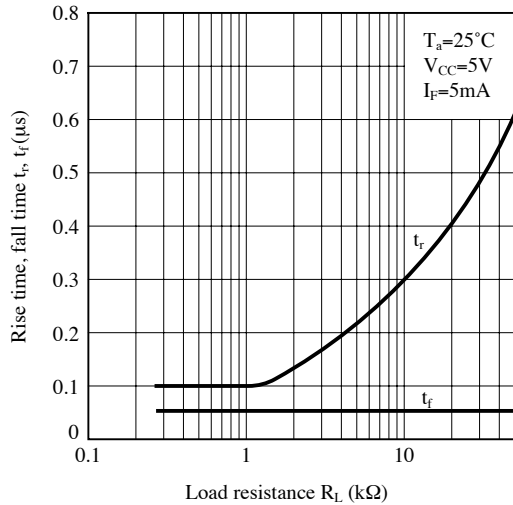

**Fig.12 Test Circuit for Response Time**

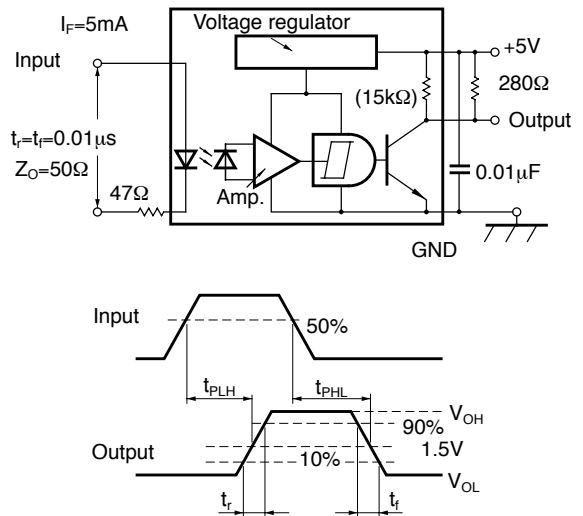

Remarks : Please be aware that all data in the graph are just for reference and not for guarantee.

■ **Design Considerations**

● **Recommended operating conditions**

Parameter	Symbol	MIN.	TYP.	MAX.	Unit
Output current	$I_O$	–	–	16	mA
Forward current	$I_F$	10	–	20	mA
Operating temperature	$T_{opr}$	0	–	70	°C

● **Notes about static electricity**

Transistor of detector side in bipolar configuration may be damaged by static electricity due to its minute design.

When handling these devices, general countermeasure against static electricity should be taken to avoid breakdown of devices or degradation of characteristics.

● **Design guide**

1) Prevention of detection error

To prevent photointerrupter from faulty operation caused by external light, do not set the detecting face to the external light.

2) In order to stabilize power supply line, connect a by-pass capacitor of more than 0.01 $\mu$ F between  $V_{CC}$  and GND near the device.

3) Position of opaque board

Opaque board shall be installed at place 4mm or more from the top of elements.

(Example)

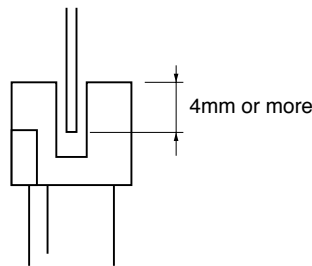

This product is not designed against irradiation and incorporates non-coherent IRED.

● **Degradation**

In general, the emission of the IRED used in photocouplers will degrade over time.

In the case of long term operation, please take the general IRED degradation (50% degradation over 5 years) into the design consideration.



## ● Parts

This product is assembled using the below parts.

- Photodetector (qty. : 1) [Using a silicon photodiode as light detecting portion, and a bipolar IC as signal processing circuit]

Category	Maximum Sensitivity wavelength (nm)	Sensitivity wavelength (nm)	Response time (μs)
Photodiode	900	400 to 1 200	3

- Photo emitter (qty. : 1)

Category	Material	Maximum light emitting wavelength (nm)	I/O Frequency (MHz)
Infrared emitting diode (non-coherent)	Gallium arsenide (GaAs)	950	0.3

- Material

Case	Lead frame plating
Black NORYL resin	Solder dip. (Sn-3Ag-0.5Cu)

- Others

Laser generator is not used.

---

**■ Manufacturing Guidelines****● Soldering Method****Flow Soldering:**

Soldering should be completed below 260°C and within 5 s.

Please take care not to let any external force exert on lead pins.

Please don't do soldering with preheating, and please don't do soldering by reflow.

**Hand soldering**

Hand soldering should be completed within 3 s when the point of solder iron is below 350°C.

Please solder within one time.

Please don't touch the terminals directly by soldering iron.

Soldered product shall treat at normal temperature.

**Other notice**

Please test the soldering method in actual condition and make sure the soldering works fine, since the impact on the junction between the device and PCB varies depending on the cooling and soldering conditions.

**Flux**

Some flux, which is used in soldering, may crack the package due to synergistic effect of alcohol in flux and the rise in temperature by heat in soldering. Therefore, in using flux, please make sure that it does not have any influence on appearance and reliability of the photointerrupter.

**● Cleaning instructions****Solvent cleaning :**

Solvent temperature should be 45°C or below. Immersion time should be 3 minutes or less.

**Ultrasonic cleaning :**

The effect to device by ultrasonic cleaning differs by cleaning bath size, ultrasonic power output, cleaning time, PCB size or device mounting condition etc.

Please test it in actual using condition and confirm that doesn't occur any defect before starting the ultrasonic cleaning.

**Recommended solvent materials :**

Ethyl alcohol, Methyl alcohol and Isopropyl alcohol.

**● Presence of ODC**

This product shall not contain the following materials.

And they are not used in the production process for this product.

Regulation substances : CFCs, Halon, Carbon tetrachloride, 1.1.1-Trichloroethane (Methylchloroform)

Specific brominated flame retardants such as the PBBOs and PBBs are not used in this product at all.

This product shall not contain the following materials banned in the RoHS Directive (2002/95/EC).

•Lead, Mercury, Cadmium, Hexavalent chromium, Polybrominated biphenyls (PBB), Polybrominated diphenyl ethers (PBDE).

**■ Package specification****● Case package**

## Package materials

Anti-static plastic bag : Polyethylene

Moltopren : Urethane

Partition : Corrugated fiberboard

Packing case : Corrugated fiberboard

## Package method

100 pcs of products shall be packaged in a plastic bag, Ends shall be fixed by stoppers. The bottom of the packing case is covered with moltopren, and the partition is set in the packing case. Each partition should have 1 plastic bag.

The 10 plastic bags containing a product are put in the packing case.

Moltopren should be located after all product are settled (1 packing contains 1 000 pcs).

## Packing composition

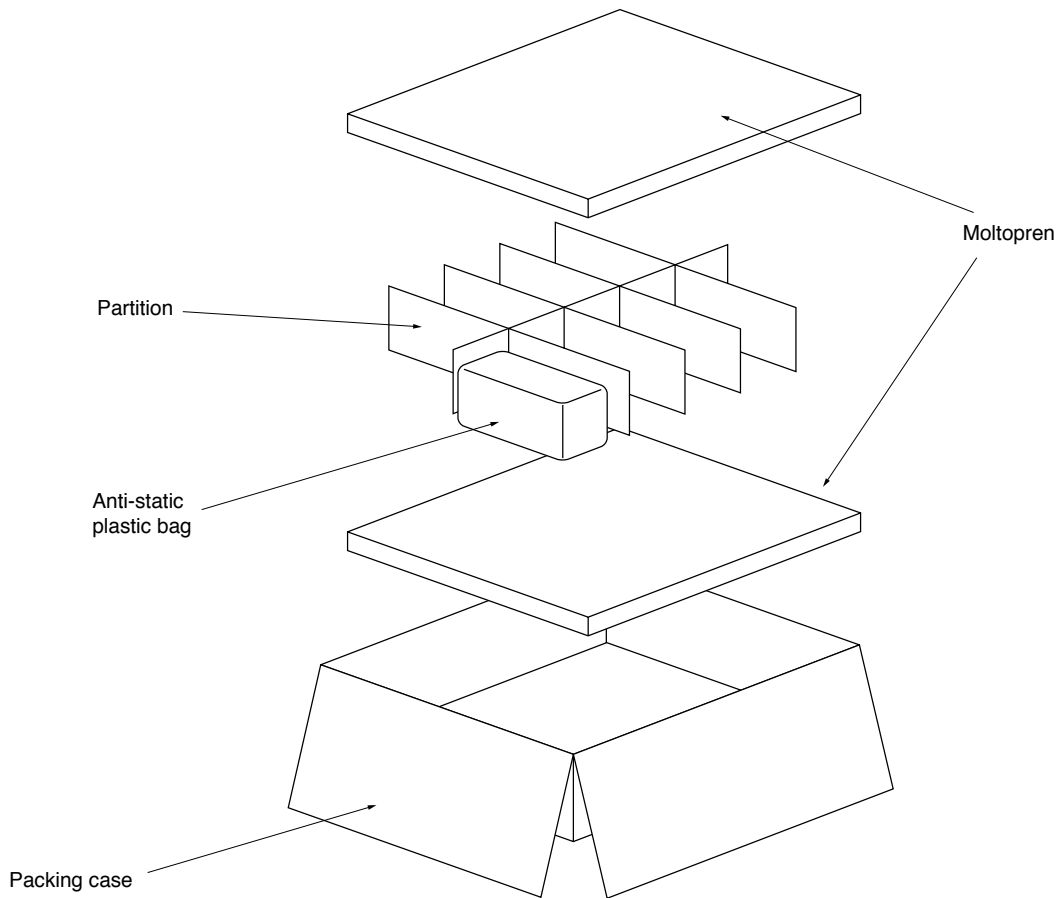

## ■ Important Notices

· The circuit application examples in this publication are provided to explain representative applications of SHARP devices and are not intended to guarantee any circuit design or license any intellectual property rights. SHARP takes no responsibility for any problems related to any intellectual property right of a third party resulting from the use of SHARP's devices.

· Contact SHARP in order to obtain the latest device specification sheets before using any SHARP device. SHARP reserves the right to make changes in the specifications, characteristics, data, materials, structure, and other contents described herein at any time without notice in order to improve design or reliability. Manufacturing locations are also subject to change without notice.

· Observe the following points when using any devices in this publication. SHARP takes no responsibility for damage caused by improper use of the devices which does not meet the conditions and absolute maximum ratings to be used specified in the relevant specification sheet nor meet the following conditions:

(i) The devices in this publication are designed for use in general electronic equipment designs such as:

- Personal computers
- Office automation equipment
- Telecommunication equipment [terminal]
- Test and measurement equipment
- Industrial control
- Audio visual equipment
- Consumer electronics

(ii) Measures such as fail-safe function and redundant design should be taken to ensure reliability and safety when SHARP devices are used for or in connection

with equipment that requires higher reliability such as:

- Transportation control and safety equipment (i.e., aircraft, trains, automobiles, etc.)
- Traffic signals
- Gas leakage sensor breakers
- Alarm equipment
- Various safety devices, etc.

(iii) SHARP devices shall not be used for or in connection with equipment that requires an extremely high level of reliability and safety such as:

- Space applications
- Telecommunication equipment [trunk lines]
- Nuclear power control equipment
- Medical and other life support equipment (e.g., scuba).

· If the SHARP devices listed in this publication fall within the scope of strategic products described in the Foreign Exchange and Foreign Trade Law of Japan, it is necessary to obtain approval to export such SHARP devices.

· This publication is the proprietary product of SHARP and is copyrighted, with all rights reserved. Under the copyright laws, no part of this publication may be reproduced or transmitted in any form or by any means, electronic or mechanical, for any purpose, in whole or in part, without the express written permission of SHARP. Express written permission is also required before any use of this publication may be made by a third party.

· Contact and consult with a SHARP representative if there are any questions about the contents of this publication.