



Chipsmall Limited consists of a professional team with an average of over 10 year of expertise in the distribution of electronic components. Based in Hongkong, we have already established firm and mutual-benefit business relationships with customers from,Europe,America and south Asia,supplying obsolete and hard-to-find components to meet their specific needs.

With the principle of “Quality Parts,Customers Priority,Honest Operation,and Considerate Service”,our business mainly focus on the distribution of electronic components. Line cards we deal with include Microchip,ALPS,ROHM,Xilinx,Pulse,ON,Everlight and Freescale. Main products comprise IC,Modules,Potentiometer,IC Socket,Relay,Connector.Our parts cover such applications as commercial,industrial, and automotives areas.

We are looking forward to setting up business relationship with you and hope to provide you with the best service and solution. Let us make a better world for our industry!



## Contact us

Tel: +86-755-8981 8866 Fax: +86-755-8427 6832

Email & Skype: info@chipsmall.com Web: www.chipsmall.com

Address: A1208, Overseas Decoration Building, #122 Zhenhua RD., Futian, Shenzhen, China



**Features**

- Low gate charge
- 100% avalanche tested
- Improved dv/dt capability
- RoHS compliant
- Halogen free package
- JEDEC Qualification
- Fast reverse recovery

$V_{DSS} = 500V$

$I_D = 4A$

$R_{DS(ON)} = 1.85 \Omega(\text{max}) @ V_{GS} = 10 V$

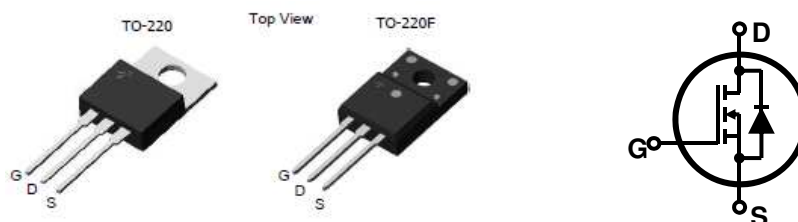

Device	Package	Marking	Remark
GP1M005A050HS	TO-220	GP1M005A050HS	RoHS
GP1M005A050FSH	TO-220F	GP1M005A050FSH	Halogen Free

**Absolute Maximum Ratings**

Parameter	Symbol	GP1M005A050HS	GP1M005A050FSH	Unit
Drain-Source Voltage	$V_{DSS}$	500		V
Gate-Source Voltage	$V_{GS}$	±30		V
Continuous Drain Current	$T_C = 25 \text{ }^\circ\text{C}$	4	4 *	A
	$T_C = 100 \text{ }^\circ\text{C}$	2.8	2.8 *	A
Pulsed Drain Current (Note 1)	$I_{DM}$	16	16*	A
Single Pulse Avalanche Energy (Note 2)	$E_{AS}$	240		mJ
Repetitive Avalanche Current (Note 1)	$I_{AR}$	4		A
Repetitive Avalanche Energy (Note 1)	$E_{AR}$	9.25		mJ
Power Dissipation	$T_C = 25 \text{ }^\circ\text{C}$	92.5	32	W
	Derate above 25 °C	0.74	0.25	W/°C
Peak Diode Recovery dv/dt (Note 3)	dv/dt	4.5		V/ns
Operating Junction and Storage Temperature Range	$T_J, T_{STG}$	-55~150		°C
Maximum lead temperature for soldering purposes, 1/8" from case for 5 seconds	$T_L$	300		°C

\* Limited only by maximum junction temperature

**Thermal Characteristics**

Parameter	Symbol	GP1M005A050HS	GP1M005A050FSH	Unit
Maximum Thermal resistance, Junction-to-Case	$R_{\theta JC}$	1.35	3.9	°C/W
Maximum Thermal resistance, Junction-to-Ambient	$R_{\theta JA}$	62.5	62.5	°C/W

**Electrical Characteristics :  $T_C=25^\circ\text{C}$ , unless otherwise noted**

Parameter	Symbol	Test condition	Min	Typ	Max	Units
<b>OFF</b>						
Drain-Source Breakdown Voltage	$BV_{DSS}$	$V_{GS} = 0\text{ V}, I_D = 250\ \mu\text{A}$	500	--	--	V
Zero Gate Voltage Drain Current	$I_{DSS}$	$V_{DS} = 500\text{ V}, V_{GS} = 0\text{ V}$	--	--	1	$\mu\text{A}$
		$V_{DS} = 400\text{ V}, T_C = 125^\circ\text{C}$	--	--	10	$\mu\text{A}$
Forward Gate-Source Leakage Current	$I_{GSSF}$	$V_{GS} = 30\text{ V}, V_{DS} = 0\text{ V}$	--	--	100	nA
Reverse Gate-Source Leakage Current	$I_{GSSR}$	$V_{GS} = -30\text{ V}, V_{DS} = 0\text{ V}$	--	--	-100	nA
<b>ON</b>						
Gate Threshold Voltage	$V_{GS(th)}$	$V_{DS} = V_{GS}, I_D = 250\ \mu\text{A}$	1.5	--	3.5	V
Drain-Source On-Resistance	$R_{DS(on)}$	$V_{GS} = 10\text{ V}, I_D = 2\text{ A}$	--	1.5	1.85	$\Omega$
Forward Transconductance <sup>(Note 4)</sup>	$g_{FS}$	$V_{DS} = 30\text{ V}, I_D = 2\text{ A}$	--	8	--	S
<b>DYNAMIC</b>						
Input Capacitance	$C_{iss}$	$V_{DS} = 25\text{ V}, V_{GS} = 0\text{ V},$ $f = 1.0\text{ MHz}$	--	602	--	pF
Output Capacitance	$C_{oss}$		--	63	--	pF
Reverse Transfer Capacitance	$C_{rss}$		--	7.1	--	pF
<b>SWITCHING</b>						
Turn-On Delay Time <sup>(Note 4,5)</sup>	$t_{d(on)}$	$V_{DD} = 250\text{ V}, I_D = 4\text{ A},$ $R_G = 25\ \Omega$	--	40	--	ns
Turn-On Rise Time <sup>(Note 4,5)</sup>	$t_r$		--	25	--	ns
Turn-Off Delay Time <sup>(Note 4,5)</sup>	$t_{d(off)}$		--	92	--	ns
Turn-Off Fall Time <sup>(Note 4,5)</sup>	$t_f$		--	35	--	ns
Total Gate Charge <sup>(Note 4,5)</sup>	$Q_g$	$V_{DS} = 400\text{ V}, I_D = 4\text{ A},$ $V_{GS} = 10\text{ V}$	--	11	--	nC
Gate-Source Charge <sup>(Note 4,5)</sup>	$Q_{gs}$		--	2.8	--	nC
Gate-Drain Charge <sup>(Note 4,5)</sup>	$Q_{gd}$		--	2.8	--	nC
<b>SOURCE DRAIN DIODE</b>						
Maximum Continuous Drain-Source Diode Forward Current	$I_S$	----	--	--	4	A
Maximum Pulsed Drain-Source Diode Forward Current	$I_{SM}$	----	--	--	16	A
Drain-Source Diode Forward Voltage	$V_{SD}$	$V_{GS} = 0\text{ V}, I_S = 4\text{ A}$	--	--	1.5	V
Reverse Recovery Time <sup>(Note 4)</sup>	$t_{rr}$	$V_{GS} = 0\text{ V}, I_S = 4\text{ A}$ $dI_F / dt = 100\text{ A}/\mu\text{s}$	--	93	--	ns
Reverse Recovery Charge <sup>(Note 4)</sup>	$Q_{rr}$		--	192	--	nC

Note :

1. Repeated rating : Pulse width limited by safe operating area
2.  $L=27\text{mH}, I_{AS} = 4\text{ A}, V_{DD} = 50\text{ V}, R_G = 25\ \Omega$ , Starting  $T_J = 25^\circ\text{C}$
3.  $I_{SD} \leq 4\text{ A}, di/dt \leq 200\text{ A}/\mu\text{s}, V_{DD} \leq BV_{DS}$ , Starting  $T_J = 25^\circ\text{C}$
4. Pulse Test : Pulse width  $\leq 300\ \mu\text{s}$ , Duty Cycle  $\leq 2\%$
5. Essentially Independent of Operating Temperature Typical Characteristics

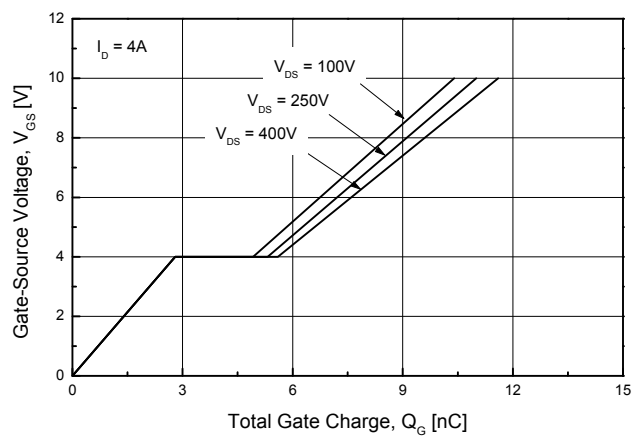
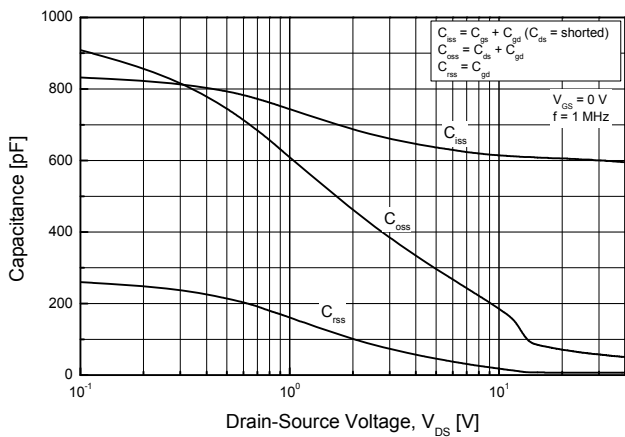
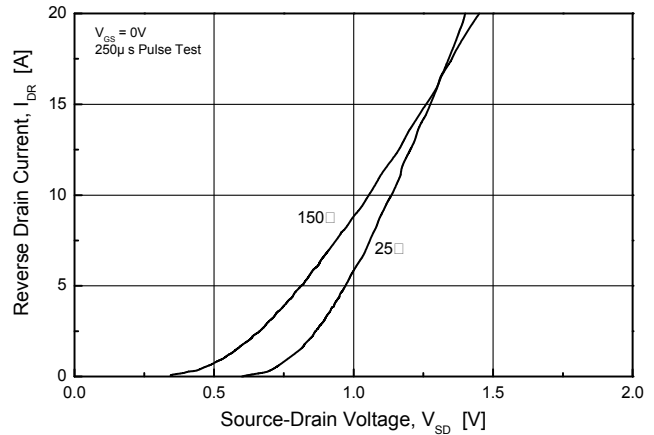
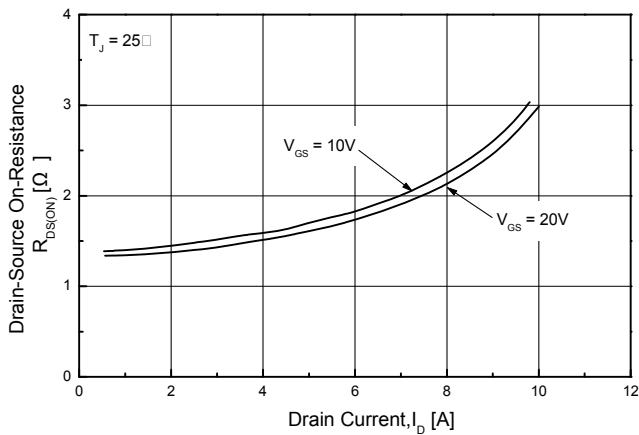
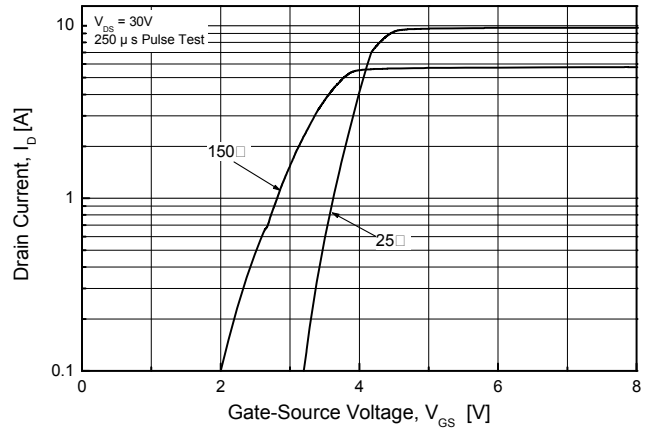
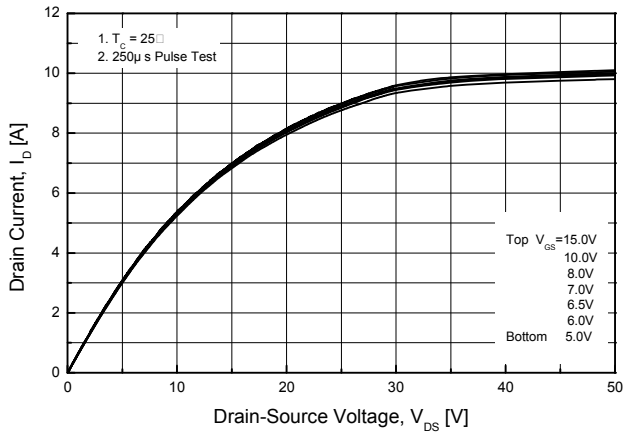

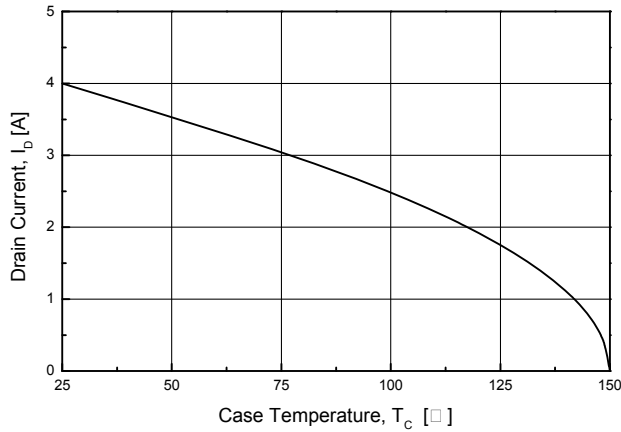
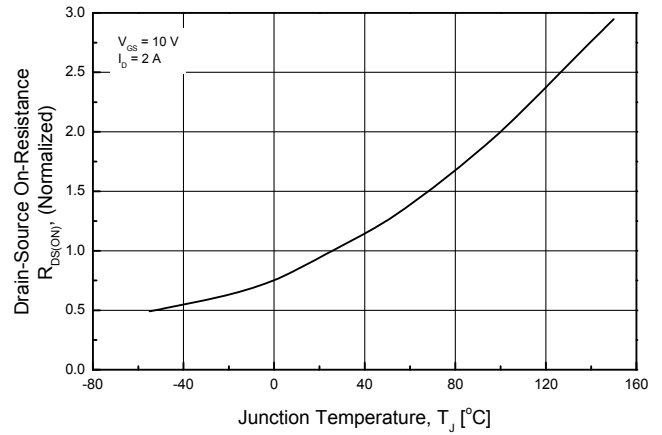
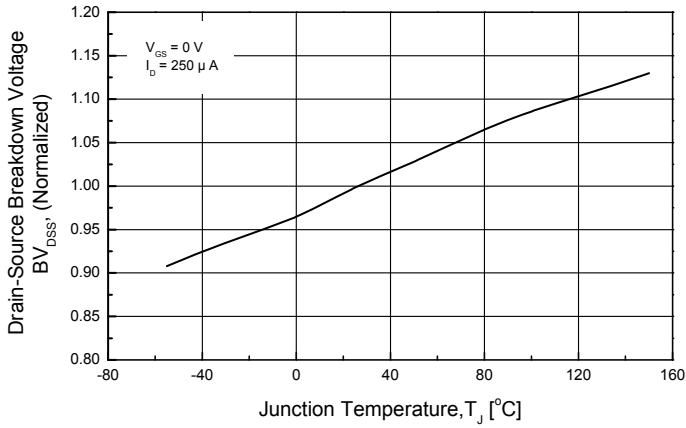

**GP1M005A050HS**

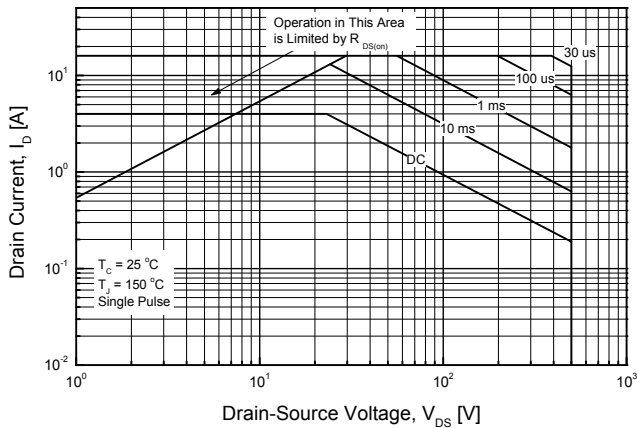

**GP1M005A050FSH**

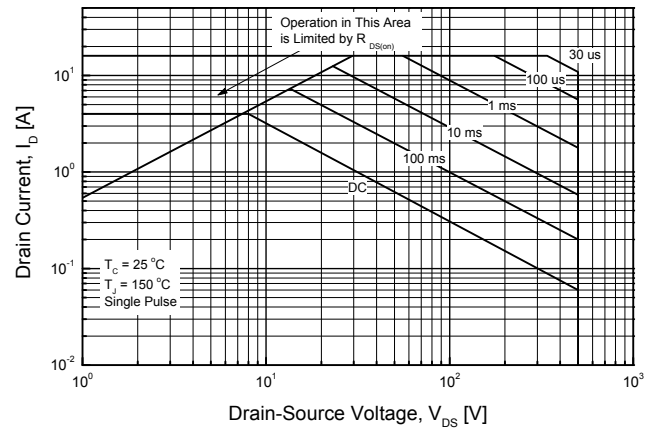

TMP5N50SG

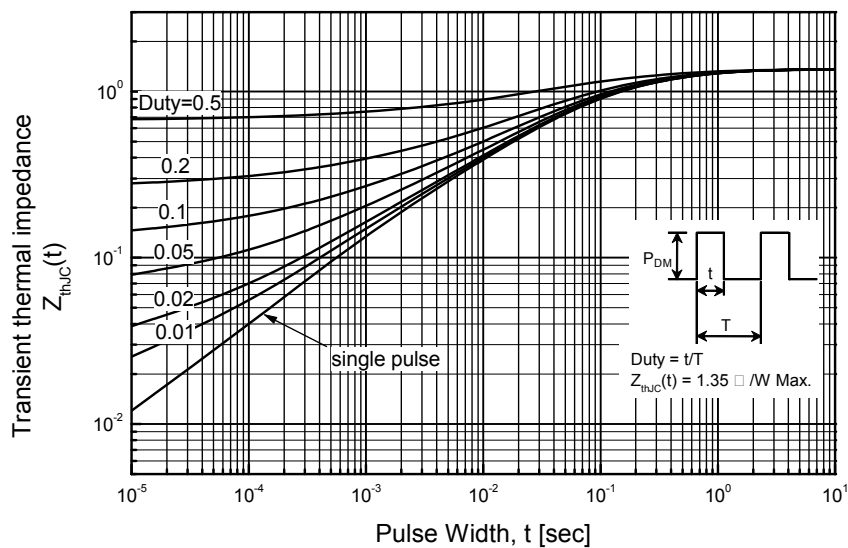

TMPF5N50SG

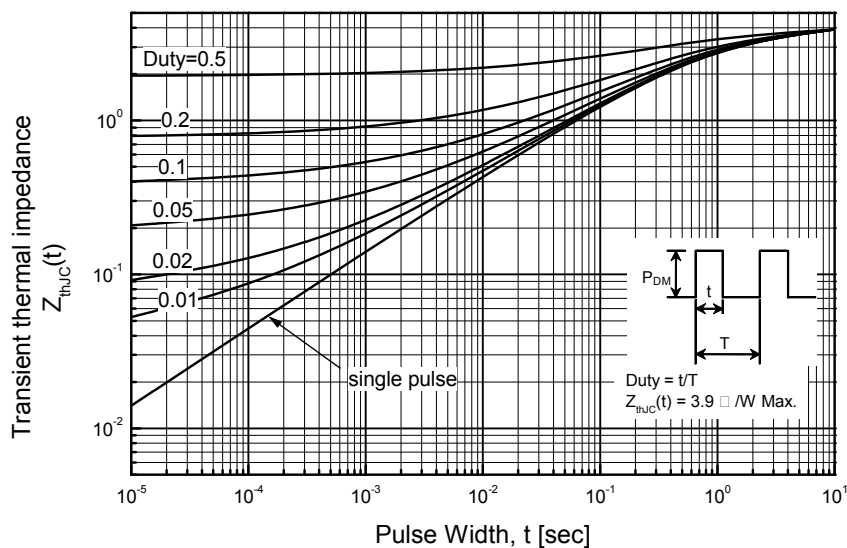

**TO-220AB-3L MECHANICAL DATA**

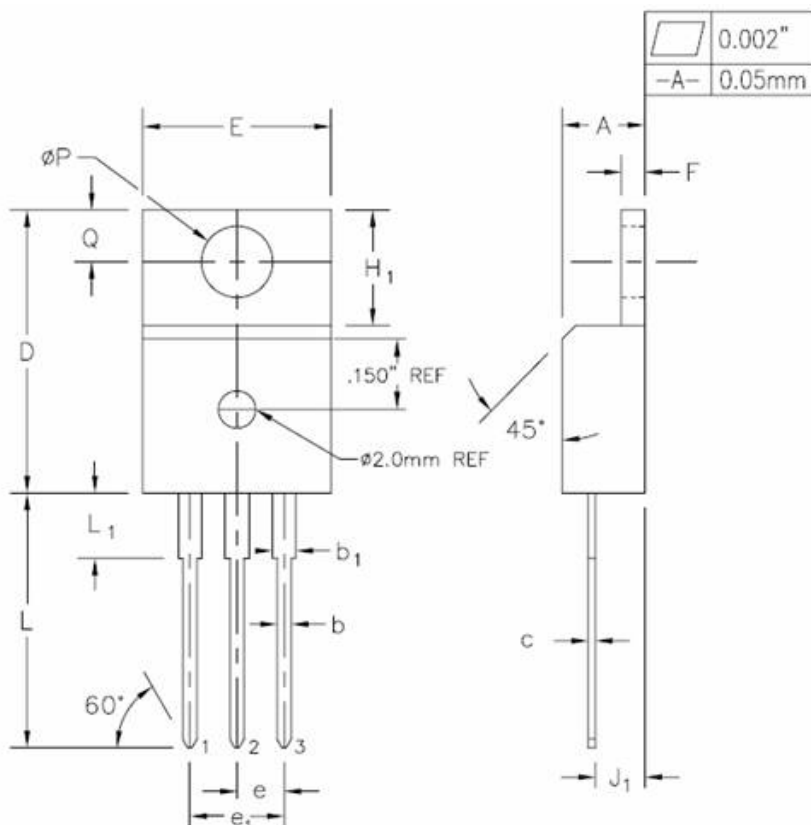

SYMBOL	INCHES		MILLIMETERS		NOTES
	MIN.	MAX.	MIN.	MAX.	
A	0.170	0.180	4.32	4.57	
b	0.028	0.036	0.71	0.91	
b <sub>1</sub>	0.045	0.055	1.15	1.39	
c	0.014	0.021	0.36	0.53	
D	0.590	0.610	14.99	15.49	
E	0.395	0.410	10.04	10.41	
e	0.100 TYP.		2.54 TYP.		
e <sub>1</sub>	0.200 BSC		5.08 BSC		
F	0.048	0.054	1.22	1.37	
H <sub>1</sub>	0.235	0.255	5.97	6.47	
J <sub>1</sub>	0.100	0.110	2.54	2.79	
L	0.530	0.550	13.47	13.97	
L <sub>1</sub>	0.130	0.150	3.31	3.81	2
$\phi P$	0.149	0.153	3.79	3.88	
Q	0.102	0.112	2.60	2.84	

**TO-220F-3L MECHANICAL DATA**

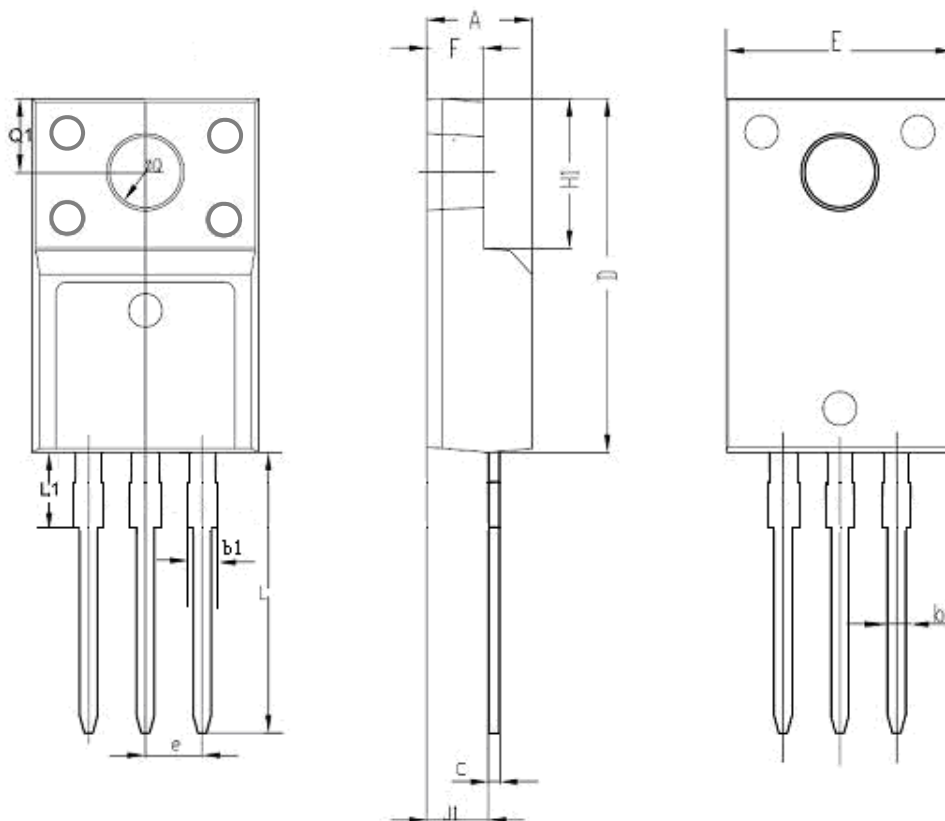

SYMBOL	INCHES		MILLIMETERS		NOTES
	MIN	MAX	MIN	MAX	
A	0.178	0.194	4.53	4.93	
b	0.028	0.036	0.71	0.91	
C	0.018	0.024	0.45	0.60	
D	0.617	0.633	15.67	16.07	
E	0.392	0.408	9.96	10.36	
e	0.100 TYP.		2.54TYP.		
H1	0.256	0.272	6.50	6.90	
J1	0.101	0.117	2.56	2.96	
L	0.503	0.519	12.78	13.18	
φQ	0.117	0.133	2.98	3.38	
b1	0.045	0.055	1.15	1.39	
L1	0.114	0.130	2.9	3.3	
Q1	0.122	0.138	3.10	3.50	
F	0.092	0.108	2.34	2.74	