



Chipsmall Limited consists of a professional team with an average of over 10 year of expertise in the distribution of electronic components. Based in Hongkong, we have already established firm and mutual-benefit business relationships with customers from,Europe,America and south Asia,supplying obsolete and hard-to-find components to meet their specific needs.

With the principle of “Quality Parts,Customers Priority,Honest Operation,and Considerate Service”,our business mainly focus on the distribution of electronic components. Line cards we deal with include Microchip,ALPS,ROHM,Xilinx,Pulse,ON,Everlight and Freescale. Main products comprise IC,Modules,Potentiometer,IC Socket,Relay,Connector.Our parts cover such applications as commercial,industrial, and automotives areas.

We are looking forward to setting up business relationship with you and hope to provide you with the best service and solution. Let us make a better world for our industry!



Contact us

Tel: +86-755-8981 8866 Fax: +86-755-8427 6832

Email & Skype: info@chipsmall.com Web: www.chipsmall.com

Address: A1208, Overseas Decoration Building, #122 Zhenhua RD., Futian, Shenzhen, China



Features

- Low gate charge
- 100% avalanche tested
- Improved dv/dt capability
- RoHS compliant
- Halogen free package
- JEDEC Qualification
- Fast reverse recovery

$$V_{DSS} = 550 \text{ V @ } T_{jmax}$$

$$I_D = 4.5 \text{ A}$$

$$R_{DS(ON)} = 1.65 \Omega(\text{max}) @ V_{GS} = 10 \text{ V}$$

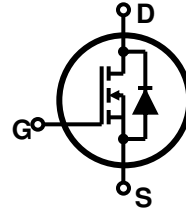

Device	Package	Marking	Remark
GP1M005A050CH	D-PAK	GP1M005A050CH	Halogen Free
GP1M005A050PH	I-PAK	GP1M005A050PH	Halogen Free

Absolute Maximum Ratings

Parameter	Symbol	Value	Unit	
Drain-Source Voltage	V_{DSS}	500	V	
Gate-Source Voltage	V_{GS}	±30	V	
Continuous Drain Current	I_D	$T_C = 25 \text{ }^\circ\text{C}$	4.5	A
		$T_C = 100 \text{ }^\circ\text{C}$	2.86	A
Pulsed Drain Current ^(Note 1)	I_{DM}	18	A	
Single Pulse Avalanche Energy ^(Note 2)	E_{AS}	240	mJ	
Repetitive Avalanche Current ^(Note 1)	I_{AR}	4.5	A	
Repetitive Avalanche Energy ^(Note 1)	E_{AR}	9.25	mJ	
Power Dissipation	P_D	$T_C = 25 \text{ }^\circ\text{C}$	92.5	W
		Derate above 25 °C	0.74	W/°C
Peak Diode Recovery dv/dt ^(Note 3)	dv/dt	4.5	V/ns	
Operating Junction and Storage Temperature Range	T_J, T_{STG}	-55~150	°C	
Maximum lead temperature for soldering purposes, 1/8" from case for 5 seconds	T_L	300	°C	

* Limited only by maximum junction temperature

Thermal Characteristics

Parameter	Symbol	Value	Unit
Maximum Thermal resistance, Junction-to-Case	$R_{\theta JC}$	1.35	°C/W
Maximum Thermal resistance, Junction-to-Ambient	$R_{\theta JA}$	62.5	°C/W

Electrical Characteristics : $T_C=25^\circ\text{C}$, unless otherwise noted

Parameter	Symbol	Test condition	Min	Typ	Max	Units
OFF						
Drain-Source Breakdown Voltage	BV_{DSS}	$V_{GS} = 0\text{ V}, I_D = 250\ \mu\text{A}$	500	--	--	V
Zero Gate Voltage Drain Current	I_{DSS}	$V_{DS} = 500\text{ V}, V_{GS} = 0\text{ V}$	--	--	1	μA
		$V_{DS} = 400\text{ V}, T_C = 125^\circ\text{C}$	--	--	10	μA
Forward Gate-Source Leakage Current	I_{GSSF}	$V_{GS} = 30\text{ V}, V_{DS} = 0\text{ V}$	--	--	100	nA
Reverse Gate-Source Leakage Current	I_{GSSR}	$V_{GS} = -30\text{ V}, V_{DS} = 0\text{ V}$	--	--	-100	nA

ON						
Gate Threshold Voltage	$V_{GS(th)}$	$V_{DS} = V_{GS}, I_D = 250\ \mu\text{A}$	2.0	--	4.0	V
Drain-Source On-Resistance	$R_{DS(on)}$	$V_{GS} = 10\text{ V}, I_D = 2.25\text{ A}$	--	1.4	1.65	Ω
Forward Transconductance ^(Note 4)	g_{FS}	$V_{DS} = 30\text{ V}, I_D = 2.25\text{ A}$	--	6	--	S

DYNAMIC						
Input Capacitance	C_{ISS}	$V_{DS} = 25\text{ V}, V_{GS} = 0\text{ V},$ $f = 1.0\text{ MHz}$	--	627	--	pF
Output Capacitance	C_{OSS}		--	61	--	pF
Reverse Transfer Capacitance	C_{RSS}		--	4.4	--	pF

SWITCHING						
Turn-On Delay Time ^(Note 4,5)	$t_{d(on)}$	$V_{DD} = 250\text{ V}, I_D = 4.5\text{ A},$ $R_G = 25\ \Omega$	--	42	--	ns
Turn-On Rise Time ^(Note 4,5)	t_r		--	32	--	ns
Turn-Off Delay Time ^(Note 4,5)	$t_{d(off)}$		--	68	--	ns
Turn-Off Fall Time ^(Note 4,5)	t_f		--	30	--	ns
Total Gate Charge ^(Note 4,5)	Q_g	$V_{DS} = 400\text{ V}, I_D = 4.5\text{ A},$ $V_{GS} = 10\text{ V}$	--	11	--	nC
Gate-Source Charge ^(Note 4,5)	Q_{gs}		--	3.2	--	nC
Gate-Drain Charge ^(Note 4,5)	Q_{gd}		--	2.7	--	nC

SOURCE DRAIN DIODE						
Maximum Continuous Drain-Source Diode Forward Current	I_S	----	--	--	4.5	A
Maximum Pulsed Drain-Source Diode Forward Current	I_{SM}	----	--	--	18	A
Drain-Source Diode Forward Voltage	V_{SD}	$V_{GS} = 0\text{ V}, I_S = 4.5\text{ A}$	--	--	1.5	V
Reverse Recovery Time ^(Note 4)	t_{rr}	$V_{GS} = 0\text{ V}, I_S = 4.5\text{ A}$ $dI_F / dt = 100\text{ A}/\mu\text{s}$	--	255	--	ns
Reverse Recovery Charge ^(Note 4)	Q_{rr}		--	1.43	--	μC

Note :

1. Repeated rating : Pulse width limited by safe operating area
2. $L=21\text{mH}, I_{AS} = 4.5\text{A}, V_{DD} = 50\text{V}, R_G = 25\Omega,$ Starting $T_J = 25^\circ\text{C}$
3. $I_{SD} \leq 4.5\text{A}, di/dt \leq 200\text{A}/\mu\text{s}, V_{DD} \leq BV_{DS},$ Starting $T_J = 25^\circ\text{C}$
4. Pulse Test : Pulse width $\leq 300\mu\text{s},$ Duty Cycle $\leq 2\%$
5. Essentially Independent of Operating Temperature Typical Characteristics

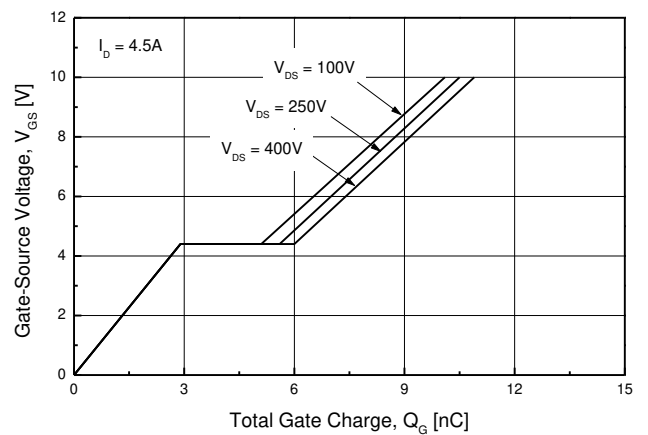
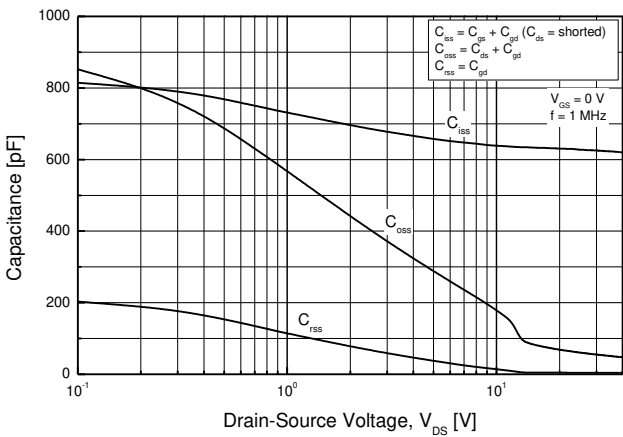
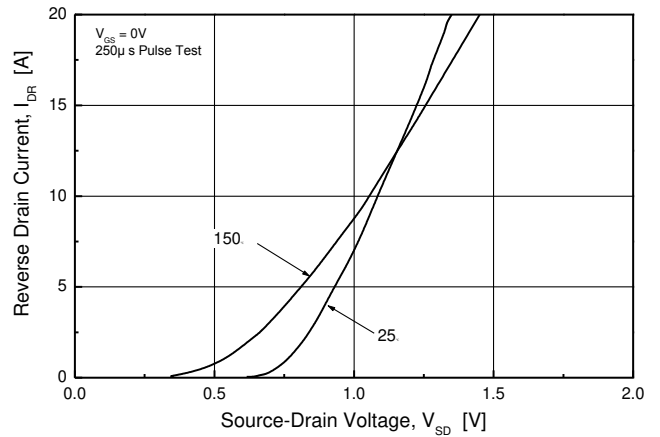
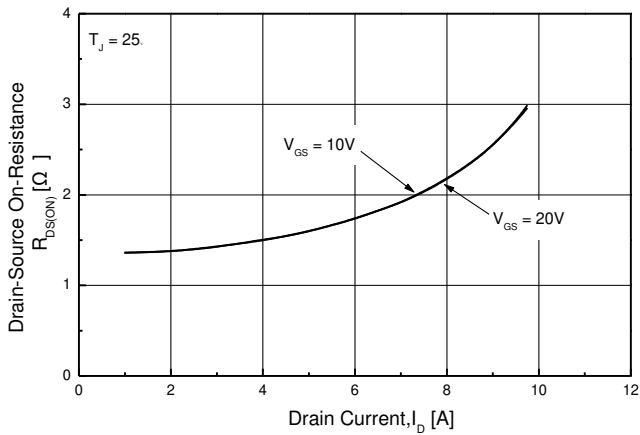
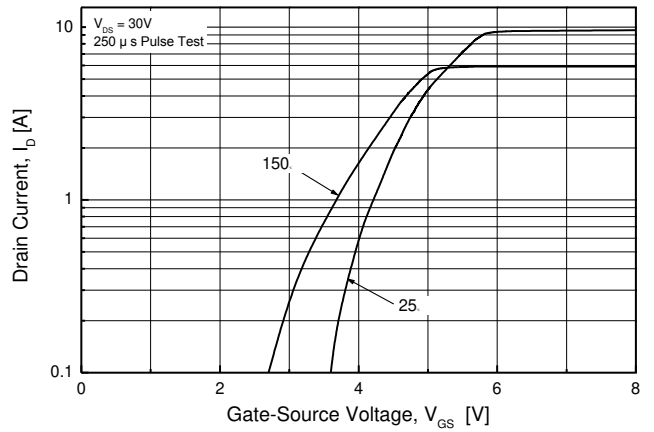
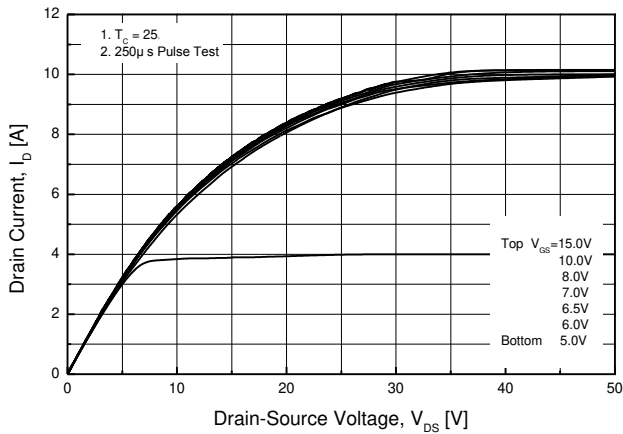

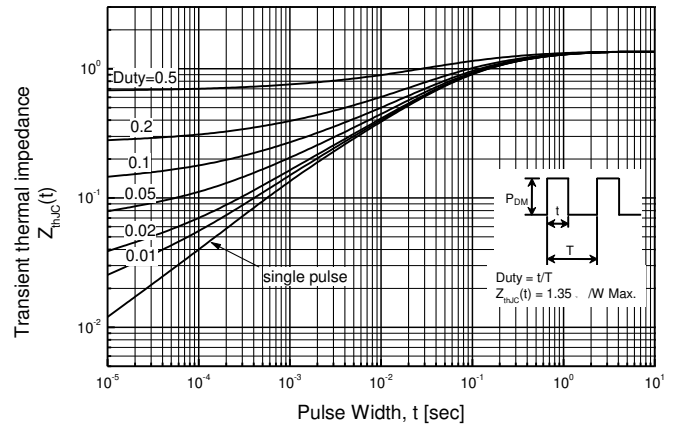
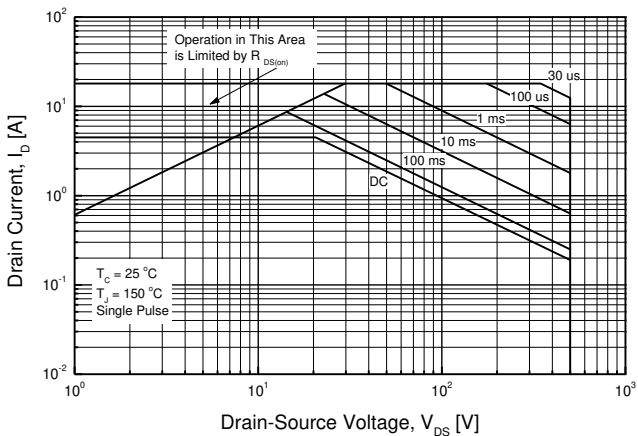
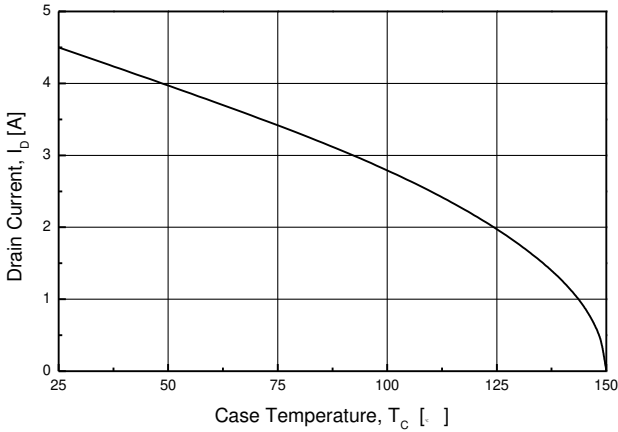
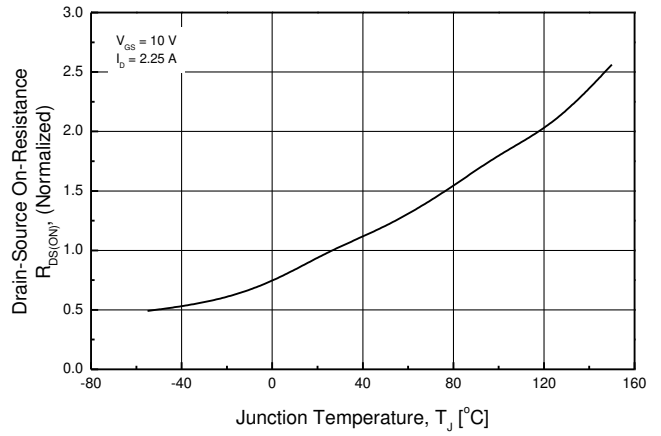
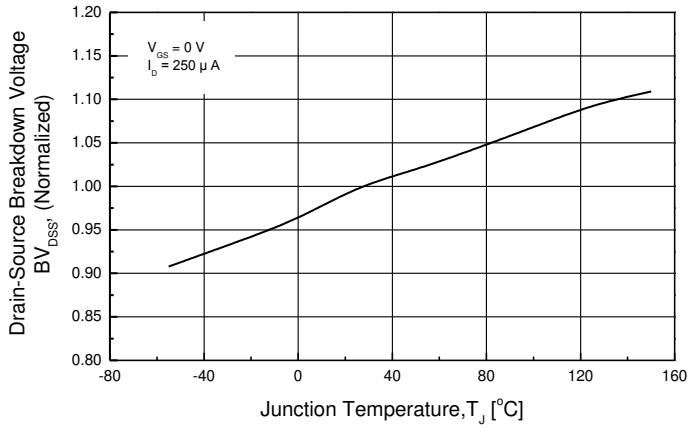

TO-252 (D-PAK) MECHANICAL DATA

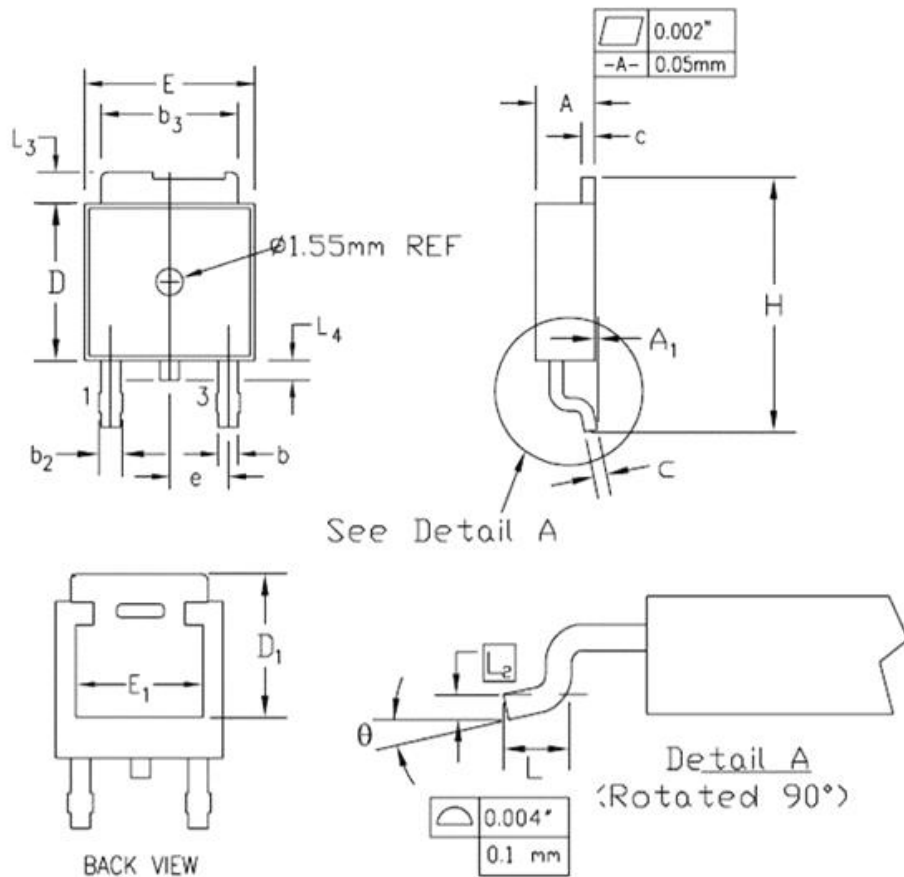

SYMBOL	INCHES		MILLIMETERS		NOTES
	MIN.	MAX.	MIN.	MAX.	
A	0.086	0.094	2.19	2.38	
A ₁	—	0.005	—	0.13	
b	0.025	0.035	0.64	0.89	
b ₂	0.033	0.045	0.84	1.14	
b ₃	0.205	0.215	5.21	5.46	
c	0.018	0.024	0.46	0.61	
D	0.235	0.245	5.97	6.22	
D ₁	0.205	—	5.21	—	2
E	0.250	0.265	6.35	6.73	
E ₁	0.190	—	4.83	—	2
e	0.090 BSC		2.29 BSC		
H	0.380	0.410	9.65	10.41	
L	0.055	0.070	1.40	1.78	4
L ₂	0.020 BSC		0.51 BSC		
L ₃	0.035	0.050	0.89	1.27	
L ₄	0.025	0.040	0.64	1.01	3
θ	0°	8°	0°	8°	

TO-251 (I-PAK) MECHANICAL DATA

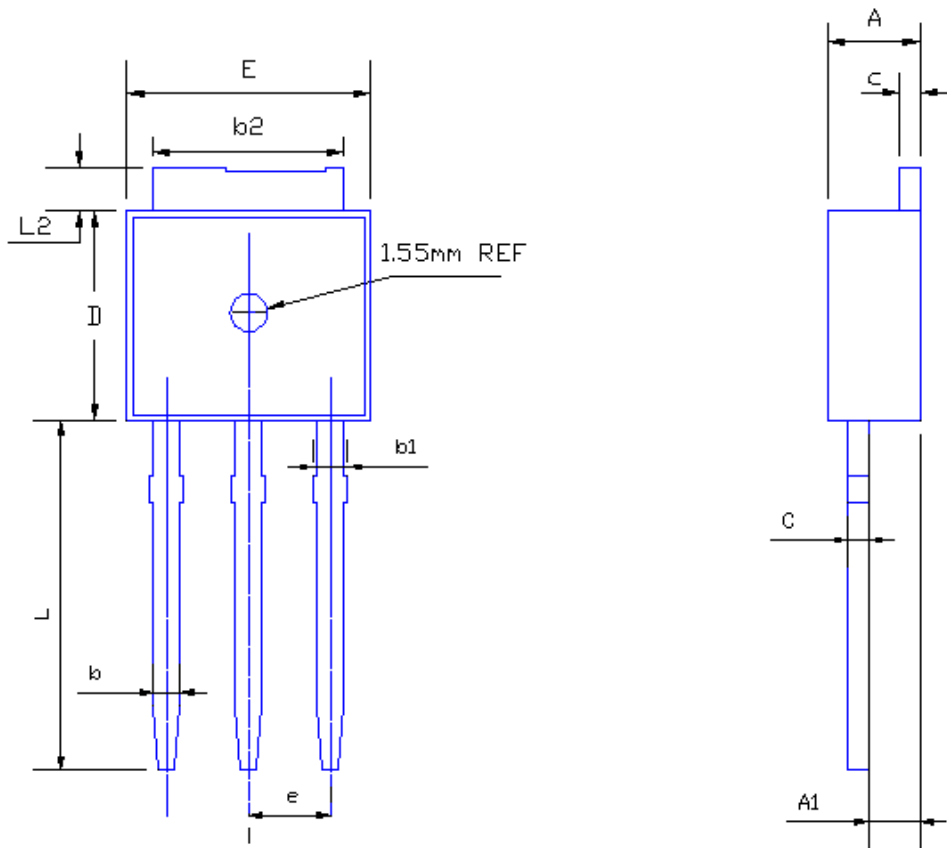

SYMBOL	MILLIMETERS	
	MIN	MAX
A	2.19	2.38
A1	1.04	1.23
b	0.64	0.89
b1	0.84	1.14
b2	5.23	5.48
c	0.46	0.61
D	5.91	6.28
E	6.21	6.59
e	2.28 TYP	
L	8.89	9.65
L2	0.89	1.27

Disclaimer :

Global Power Technologies Group reserves the right to make changes without notice to products herein to improve reliability, performance, or design. The information given in this document is believed to be accurate and reliable. However, it shall in no event be regarded as a guarantee of conditions and characteristics. With respect to any information regarding the application of the device, Global Power Technologies Group hereby disclaims any and all warranties and liabilities of any kind, including without limitation, warranties of non-infringement of patent rights of any third party.