



Chipsmall Limited consists of a professional team with an average of over 10 year of expertise in the distribution of electronic components. Based in Hongkong, we have already established firm and mutual-benefit business relationships with customers from,Europe,America and south Asia,supplying obsolete and hard-to-find components to meet their specific needs.

With the principle of “Quality Parts,Customers Priority,Honest Operation,and Considerate Service”,our business mainly focus on the distribution of electronic components. Line cards we deal with include Microchip,ALPS,ROHM,Xilinx,Pulse,ON,Everlight and Freescale. Main products comprise IC,Modules,Potentiometer,IC Socket,Relay,Connector.Our parts cover such applications as commercial,industrial, and automotives areas.

We are looking forward to setting up business relationship with you and hope to provide you with the best service and solution. Let us make a better world for our industry!



## Contact us

Tel: +86-755-8981 8866 Fax: +86-755-8427 6832

Email & Skype: info@chipsmall.com Web: www.chipsmall.com

Address: A1208, Overseas Decoration Building, #122 Zhenhua RD., Futian, Shenzhen, China



# SHARP

OPTO-ELECTRONIC DEVICES DIVISION  
ELECTRONIC COMPONENTS GROUP  
SHARP CORPORATION

## SPECIFICATION

SPEC. No. ED-03U008  
ISSUE / October 10, 2003

REFERENCE

DEVICE SPECIFICATION FOR

Infrared Detecting unit for Remote Control  
MODEL No.

GP1UE28QK00F series

Specified for

---

Enclosed please find copies of the Specifications which consists of 11 pages including cover.  
After confirmation of the contents, please be sure to send back  copies of the Specifications  
with approving signature on each.

CUSTOMER'S APPROVAL

DATE

---

BY

---

PRESENTED

DATE

---

BY

---

*K.H*  
K. Hachimura,  
Department General Manager of  
Engineering Dept., II  
Opto-Electronic Devices Div.  
ELECOM Group  
SHARP CORPORATION

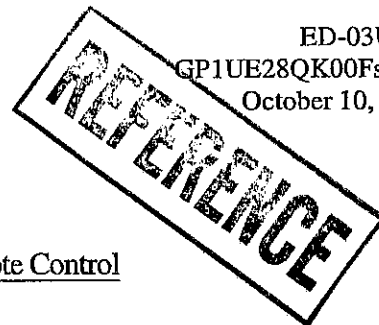

Product name : Infrared Detecting unit for Remote Control

Model No. : GP1UE28QK00F series

1. These specification sheets include materials protected under copyright of Sharp Corporation ("Sharp"). Please do not reproduce or cause anyone to reproduce them without Sharp's consent.
2. When using this product, please observe the absolute maximum ratings and the instructions for use outlined in these specification sheets, as well as the precautions mentioned below. Sharp assumes no responsibility for any damage resulting from use of the product which does not comply with the absolute maximum ratings and the instructions included in these specification sheets, and the precautions mentioned below.

(Precautions)

- (1) This product is designed for use in the following application areas ;

( • OA equipment • Audio visual equipment • Home appliances  
• Telecommunication equipment (Terminal) )

If the use of the product in the above application areas is for equipment listed in paragraphs (2) or (3), please be sure to observe the precautions given in those respective paragraphs.

- (2) Appropriate measures, such as fail-safe design and redundant design considering the safety design of the overall system and equipment, should be taken to ensure reliability and safety when this product is used for equipment which demands high reliability and safety in function and precision, such as ;

( • Transportation control and safety equipment (aircraft, train, automobile etc.)  
• Traffic signals • Gas leakage sensor breakers • Rescue and security equipment  
• Other safety equipment etc. )

- (3) Please do not use this product for equipment which require extremely high reliability and safety in function and precision, such as ;

( • Space equipment • Telecommunication equipment (for trunk lines)  
• Nuclear power control equipment • Medical equipment etc. )

- (4) Please contact and consult with a Sharp sales representative if there are any questions regarding interpretation of the above three paragraphs.

3. Please contact and consult with a Sharp sales representative for any questions about this product.

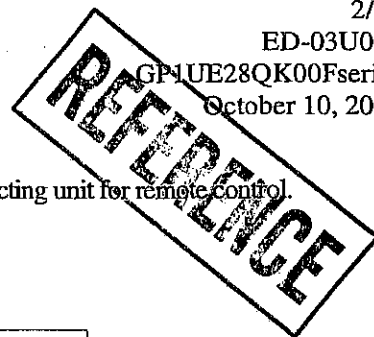

1. Application

This specifications applies to the model marked "○" in the following models of infrared detecting unit for remote control.

The model list of GP1UE28QK00F series

Application	Model No.	B.P.F. center frequency (TYP)
	GP1UE28QK00F	40 kHz
	GP1UE280QK0F	36 kHz
○	GP1UE281QK0F	38 kHz
	GP1UE282QK0F	36.7 kHz

Main application : TV set, VCR, Radio cassette recorder, Stereo

2. Outline

Refer to the attached sheet, Page 7.

3. Ratings and characteristics

Refer to the attached sheet, Page 4 to 6.

4. Reliability

Refer to the attached sheet, Page 8.

5. Outgoing inspection

Refer to the attached sheet, Page 9.

6. Supplement

1) This infrared detecting unit for remote control satisfies each performance requirements in para. 3.5, in the standard optical system in Fig.2.

2) This product is built-in photodiode.

3) Product mass : Approx. 0.7g

4) This product shall not contain the following materials.

Also, the following materials shall not be used in the production process for this product.

Materials for ODS : CFC<sub>s</sub>, Halon, Carbon tetrachloride, 1.1.1-Trichloroethane (Methylchloroform)

5) Brominated flame retardants

Specific brominated flame retardants such as the PBBO<sub>s</sub> and PBB<sub>s</sub> are not used in this device at all.

6) Packing specification : Refer to the attached sheet, Page 10.

7) Country of origin : Philippine, Indonesia

8) This product doesn't use lead.

7. Notes

1) Regarding to transmitting code

When this infrared remote control detecting unit shall be adopted for wireless remote control, please use it with the signal format of transmitter, which total duty ratio  $D_t$  (Emitting time  $\sum_{N=1}^n t_N$  / Transmitting time for 1 block  $T$ ) is 40% or less. ON signal time  $T_{ON}$  (Pulse width of the presence of modulated IR) should be 250  $\mu$ s or more. In case that the signal format of total duty and ON signal time is out of above conditions, there is a case that reception distance is much reduced or output is not appeared.

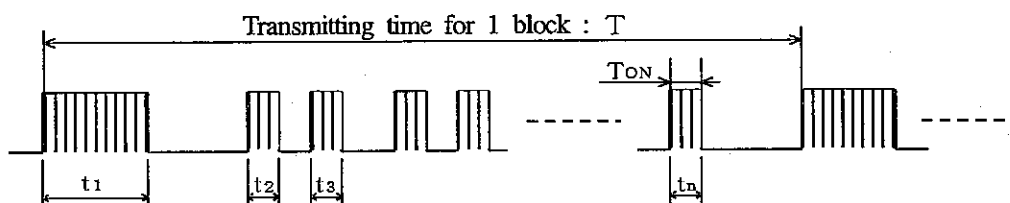

$$D_t = \left( \sum_{N=1}^n t_N / T \right) \times 100 (\%)$$

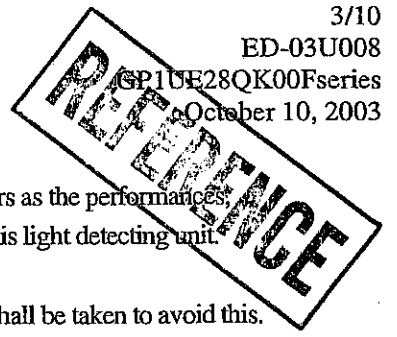

## 2) Regarding to transmitter

Please use a light emitting unit (remote control transmitter) taking into consideration such factors as the performance characteristics and operating condition of the light emitting element and the characteristics of this light detecting unit.

## 3) Regarding to detector face and cleaning

If the surface of detector is smeared with dust or dirt, it may cause faulty operation. Caution shall be taken to avoid this.

And do not touch the detector surface. If the surface was smeared, wipe it clean with soft cloth.

If any solvent is needed, Methyl alcohol, Ethyl alcohol, or Isopropyl alcohol should be used.

Please don't carry out washing. Because, after washing the remainder in solvent or flux in this device cause malfunction.

Marking on this device is defaced by washing.

## 4) Regarding to mounting this product

- The shield case shall be grounded on the PCB pattern.  
(There are two cases that shield case and GND pin are connected in the shield case, or are not connected in it.)
- It shall not be applied the terminal and case with unnecessary stress.
- Please don't push the detecting side (photodiode) from external.
- In order to prevent electrostatic discharge of integrated circuit, human body and soldering iron, etc. shall be grounded.
- The holes and the slits on the infrared detecting unit shall not be used as the other purpose to maintain its performance.
- When mounting, please mount the external circuit below. (CR filter)  
(External parts should be mounted as close as possible to the sensor.)

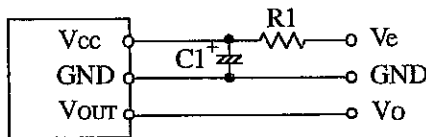

(Circuit fixed number)

$R1=47\ \Omega \pm 5\%$

$C1=47\ \mu\text{F}$

The circuit constant is a example. It is difference from mounting equipment. Please select it by your mounting equipment.

This device has a transistor as protection element between Vcc and GND to improve anti-static electricity proof.

Please be carefully not to apply exceeding the absolute maximum ratings of applying voltage and continuous high voltage spike noise because there is cases that transistor will be short by secondary breakdown generally.

In order to do difficultly, we recommend to add CR filter ( $47\ \Omega$  (1/10W),  $10\ \mu\text{F}$  or more) such as external circuit example above near Vcc.

## 5) Regarding to characteristics of this product

- There is a possibility that noise on output may be caused by environmental condition etc. even if there is no input transmission signal.
- Please shall confirm operation or your actual machine. Because the output pulse width of this product is fluctuated by environmental conditions such as signal format, temperature, distance from transmitter, and so on.

## 6) Regarding for soldering

- In case that this product is kept in high humidity condition, it may be hard to solder, please be careful enough about storage method. Depend on the flux you select, there are different solderabilities, so please select a suitable flux and use it.
- Please don't do soldering this product by reflow.

## 7) Regarding to use condition

Please use this device away from the dew drop. Be aware that the dew drop rusts shield case and others, may affect the electric characteristics.

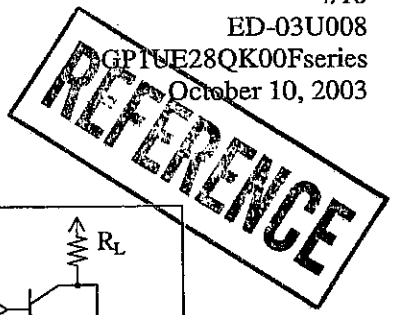

3. Ratings and characteristics

3.1 Schematic

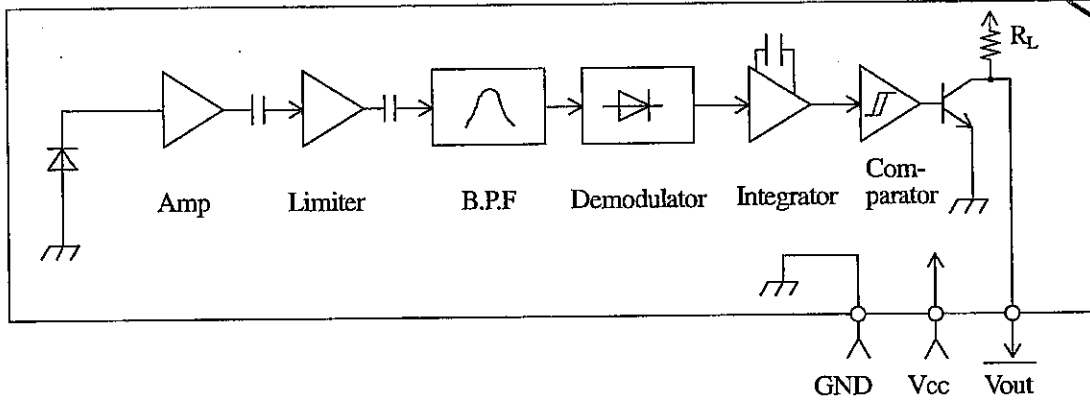

3.2 Absolute maximum ratings

Parameter	Symbol	Ratings	Unit
Supply voltage	Vcc	0 to 6.0	V
Operating temperature	Topr	-10 to +70 ※1	°C
Storage temperature	Tstg	-20 to +70	°C
Soldering temperature	Tsol	260 (Soldering time : 5s) ※2	°C

※1) No dew drop

※2) 1.6mm at mounting on single-sided PCB

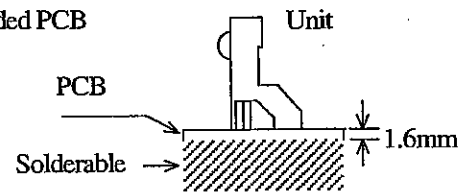

3.3 Recommended operating conditions

Parameter	Symbol	Operating condition	Unit
Supply voltage	Vcc	2.4 to 3.6	V

3.4 Electrical characteristics

(Unspecified Ta=25°C, Vcc=+3V)

Parameter	Symbol	MIN.	TYP.	MAX.	Unit	Remark
Current dissipation	Icc	-	0.4	0.6	mA	No input light
High level output voltage	V <sub>OH</sub>	Vcc-0.5	-	-	V	※3
Low level output voltage	V <sub>OL</sub>	-	-	0.45	V	※3 I <sub>OL</sub> =1.6mA
High level pulse width	T <sub>1</sub>	600	-	1200	μs	※3
Low level pulse width	T <sub>2</sub>	400	-	1000	μs	※3
B.P.F. center frequency	f <sub>0</sub>	-	※4	-	kHz	
Output pull-up resistance	R <sub>L</sub>	70	100	130	kΩ	

f<sub>0</sub>=※4 Duty 50%

※3) The burst wave as shown in the figure on the right shall be transmitted by the transmitter shown in Fig 1. However, the carrier frequency of transmitter is same as ※4 kHz. Measuring shall be from just after starting the transmission until 50 pulse.

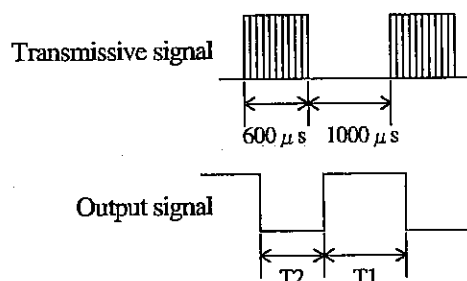

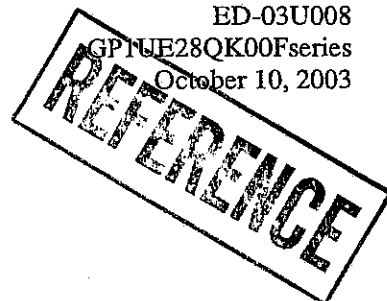

※4) B.P.F. center frequency :  $f_0$  of each model is shown in the list below.

Model No.	B.P.F. center frequency (TYP)
GP1UE28QK00F	40 kHz
GP1UE280QK0F	36 kHz
GP1UE281QK0F	38 kHz
GP1UE282QK0F	36.7 kHz

### 3.5 Performance

The output signal of this infrared detecting unit shall satisfy the following requirements with the transmitter shown in Fig.1 used in the standard optical system in Fig.2.

#### 3.5.1 Characteristics of linear reception distance

The output signal shall satisfy the electrical characteristic requirements in para. 3.4 at  $L=0.2$  to  $8.0\text{m}$ , (※5)  $E_v < 10\text{lx}$ ,  $\phi = 0^\circ$  in Fig.2.

#### 3.5.2 Characteristics of sensitivity angle reception distance

The output signal shall satisfy the electrical characteristic requirements in para. 3.4 at  $L=0.2$  to  $6.0\text{m}$ , (※5)  $E_v < 10\text{lx}$ ,  $\phi \leq 30^\circ$  in Fig.2.

#### 3.5.3 Characteristics of anti-outer peripheral light reception distance

The output signal shall satisfy the electrical characteristic requirements in para. 3.4 at  $L=0.2$  to  $4.0\text{m}$ , (※5, ※6)  $E_v \leq 300\text{lx}$ ,  $\phi = 0^\circ$  in Fig.2.

※5) It refers to detector face illuminance.

※6) Outer peripheral light source : CIE standard light source A shall be used and placed at  $45^\circ$  from the perpendicular axis at the detector face center.

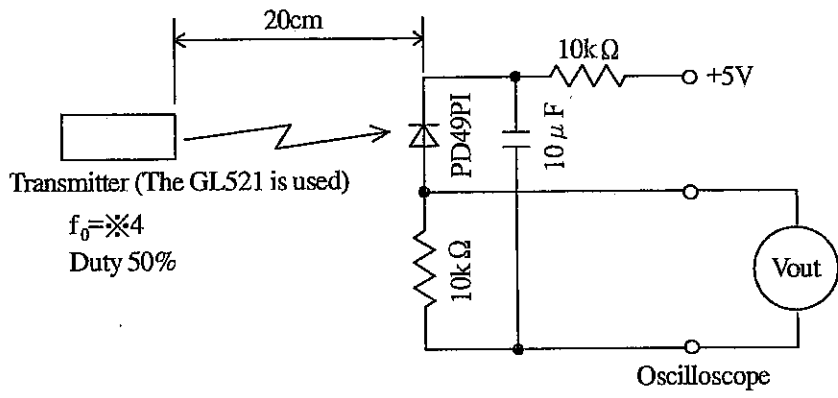
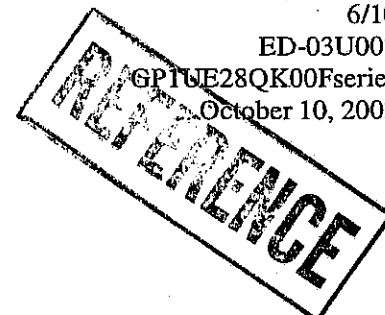

In the figure above, the transmitter shall be set as the output  $V_{out}$  (p-p) will be 40mV.  
 Note that the PD49PI in this application is the one with short-circuit current  $I_{sc} = 2.6 \mu A$  measured at  $E_v = 100lx$ . ( $E_v$  is the illuminance by CIE standard light source A (tungsten lamp)).

Fig. 1 Transmitter

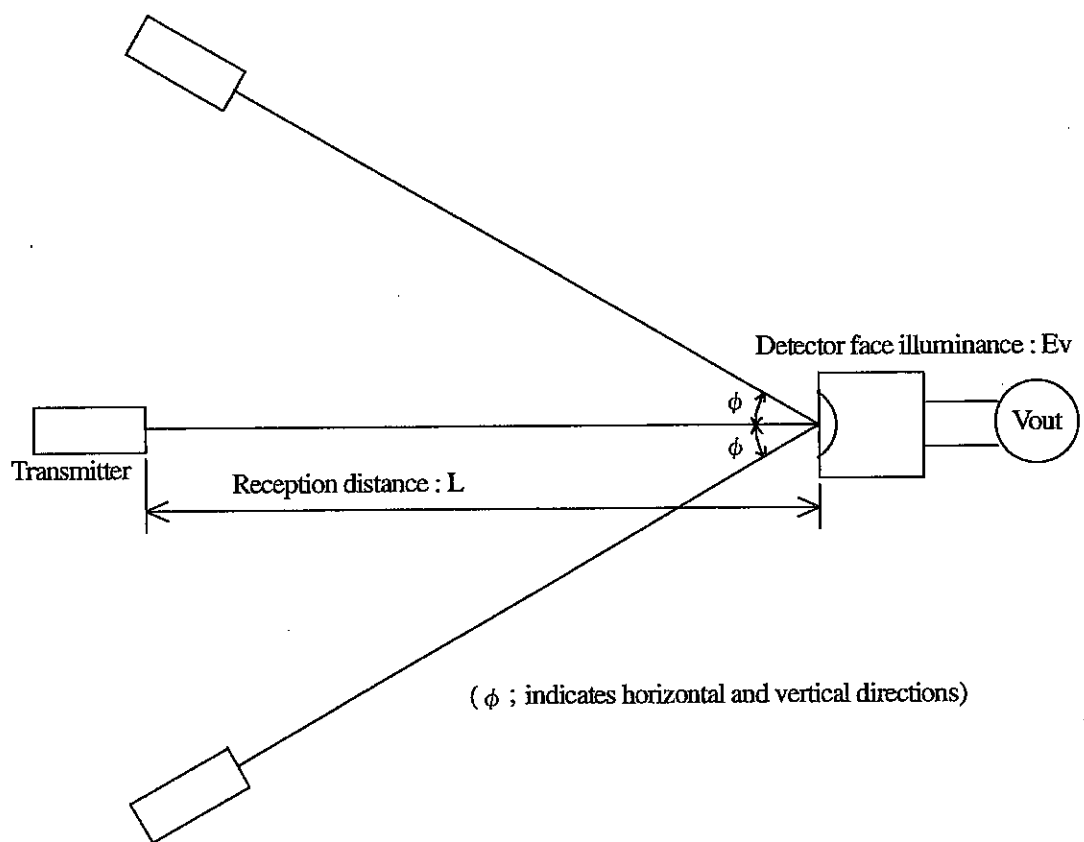

( $\phi$  ; indicates horizontal and vertical directions)

Fig.2 Standard optical system



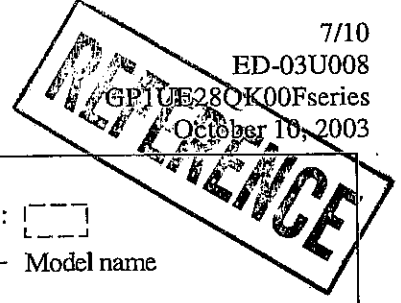

Stamp list

Model No.	Stamp
GP1UE28QK00F	Without
GP1UE281QK0F	1
GP1UE282QK0F	2
GP1UE280QK0F	0

Production place list

Lot No.	Production place
1384	Philippine
1384	Indonesia

\* Stamp area :

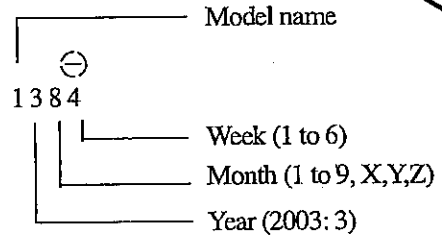

The " - " mark inside shows production place. (\*4)

\* Carved seal

- Sharp mark
- Lead less
- GP1UE28QK00F Series

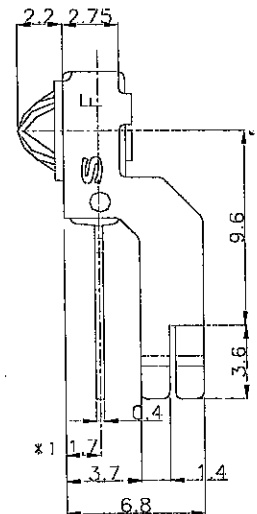
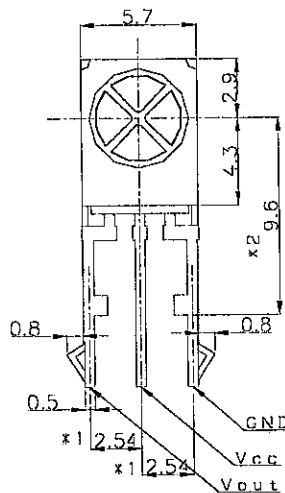
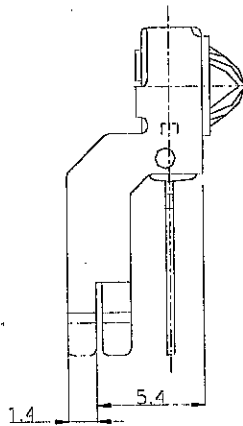
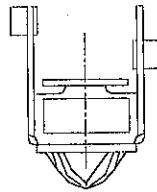

Example of mounting drawing from solder side(Reference)

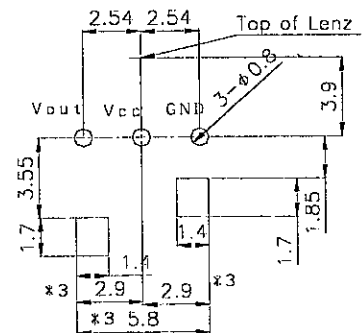
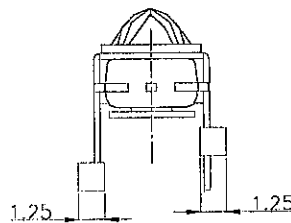

1. \*1 indicates root dimensions of lead
2. Unspecified tolerance :  $\pm 0.3$
3. Case thickness : 0.3TYP.
4. Case material : Fe
5. Case finish : 3 layer alloy (Sn, Ni, Zn) plating or Solder plating (Sn, Cu)
6. Lead material : Fe (Ag plating)
7. Lead edge finish : Solder dip(Sn,Ag,Cu)
8. Mold resin : Epoxy resin
9. Product mass : Approx. 0.7g
10. \*2 : Exclude sagged solder
11. \*3 : If there are difficulties to insert the GP1UE28QK00F series on PCB, we recommend to expand +0.1mm from original 2.9mm.
12. \*4 : The " - " mark above lot number indicate production place. (Production country is referred to the production place list)

Scale	Name	GP1UE28QK00F series Outline Dimensions
3/1		
Unit	Drawing No.	RUD3705
1=1/1mm		

REFERENCE

#### 4. Reliability

The reliability of products shall satisfy items listed below.

Confidence level : 90%

LTPD : 10 or 20

Test Items	Test Conditions	Failure Judgement Criteria	Samples (n)
			Defective(C)
Terminal strength (Tension)	Weight : 5N, 30s / each terminal	Performance test in para. 3.5 should not be satisfied.	n=11, C=0
Terminal strength (Bending)	Weight : 2.5N 0° -90° -0° , 2 times / each terminal		n=11, C=0
Shock	Acceleration : 1000m/s <sup>2</sup> , 6ms 3 directions / 3 times		n=11, C=0
Variable frequency vibration	Frequency range : 10 to 55Hz/ sweep 1min Overall amplitude : 1.5mm X, Y, Z/2h each		n=11, C=0
* High temp. and high humidity storage	Ta=40°C, 90%RH, t=240h		n=22, C=0
* High temp. storage	Ta=70°C, t=240h		n=22, C=0
* Low temp. storage	Ta=-20°C, t=240h		n=22, C=0
* Temperature cycling	1cycle -20°C to +70°C (30min) (30min) 20 cycles test		n=22, C=0
* Operation life (High temperature)	Ta=70°C, Vcc=3V, t=240h		n=22, C=0
Solder heat	MAX. 260°C, 5s (1.6mm at mounting on single-sided PCB)		n=11, C=0

In the test \*mark above, the sample to be tested shall be left at normal temperature and humidity for 2hours after it is taken out of the chamber. (No dew drop)

Solder heat tests the unit which is soldered such as Fig.3.

Fig.3

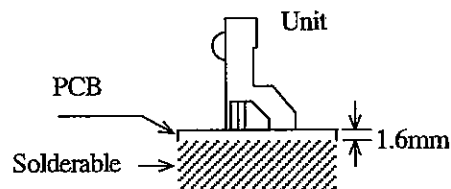

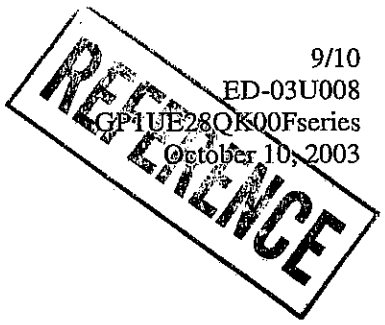

5. Outgoing inspection

(1) Inspection lot

Inspection shall be carried out per each delivery lot.

(2) Inspection method

A single sampling plan, normal inspection level II based on ISO 2859 shall be applied.

Classification of Defects		Inspection Items	AQL (%)
Major defect	1	Electrical characteristic defect of $V_{OH}$ , $V_{OL}$ , $T_1$ and $T_2$ in para. 3.4.	0.4
	2	Distance between signal terminal and shield case (0.2mm or more) (Except for GND terminal)	
	3	It should have no remarkable stains and cracks that give any influence of electrical characteristic on light detecting face.	
Minor defect	1	Deformation of shield case (Satisfying outline dimensions of item 2)	1.5
	2	Stamp, Carved seal (It should be possible to read stamp and carved seal of item 2. Stamp and carved seal should be indicated at fixed position.)	

**REFERENCE**

Package drawings

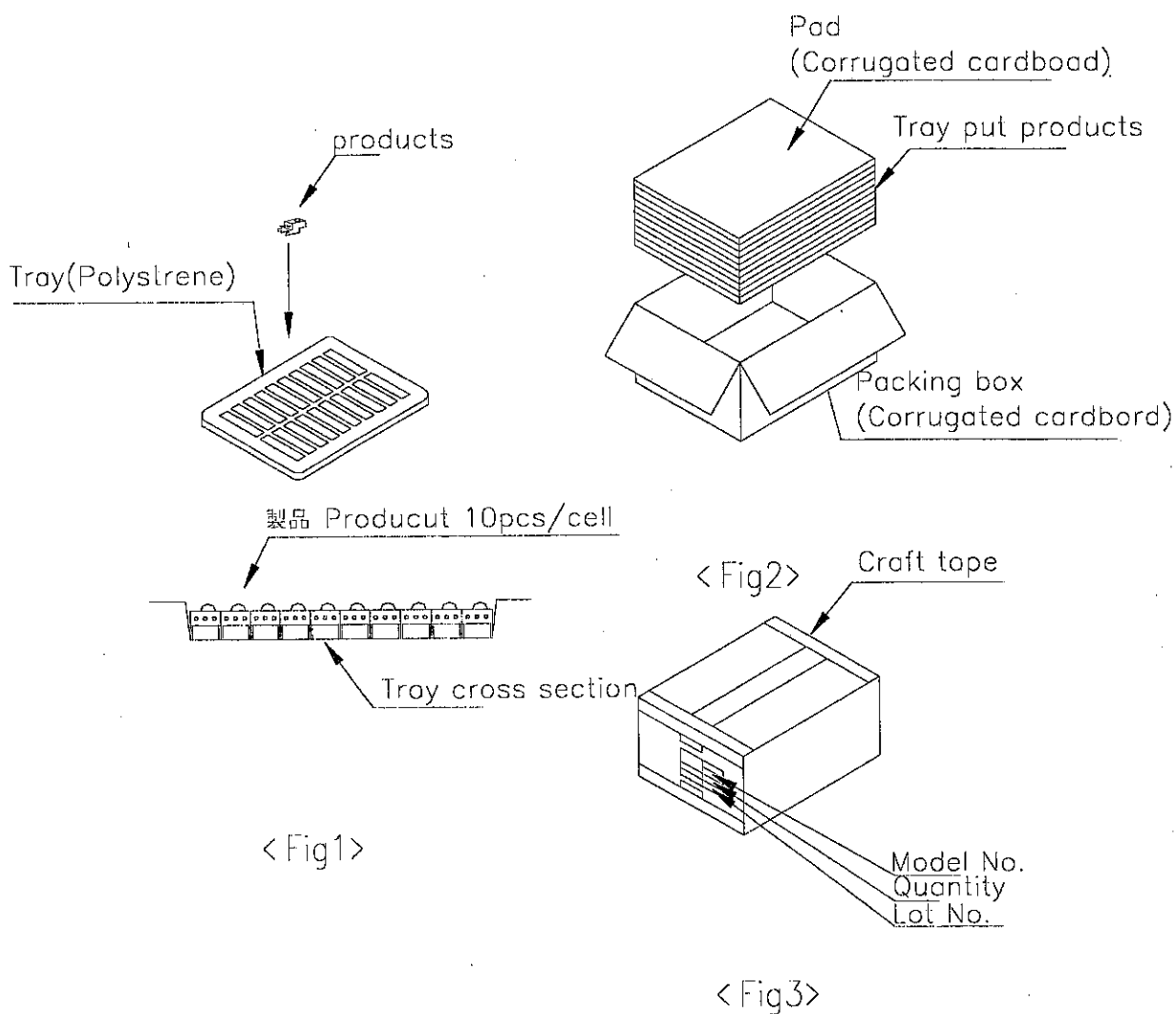

Packaging method

1. Put products of 200pcs. in the tray.  
Put direction is showed in the above fig. (Fig. 1)
2. Put them (10-tray) in the packing box.  
Put pads on their top and bottom, between pads. (Fig. 2)
3. Seal the packing box with kraft tape.  
Print the model No., quantity, lot No.  
(2000pcs. / a packing box) (Fig. 3)  
• Product mass at 2000pcs./package : Approximately 2kg

Scale	Name	GP1UE28QK00F series Packing specification
Unit		
1= / mm	Drawing No.	RUD0X14