



Chipsmall Limited consists of a professional team with an average of over 10 year of expertise in the distribution of electronic components. Based in Hongkong, we have already established firm and mutual-benefit business relationships with customers from,Europe,America and south Asia,supplying obsolete and hard-to-find components to meet their specific needs.

With the principle of “Quality Parts,Customers Priority,Honest Operation,and Considerate Service”,our business mainly focus on the distribution of electronic components. Line cards we deal with include Microchip,ALPS,ROHM,Xilinx,Pulse,ON,Everlight and Freescale. Main products comprise IC,Modules,Potentiometer,IC Socket,Relay,Connector.Our parts cover such applications as commercial,industrial, and automotives areas.

We are looking forward to setting up business relationship with you and hope to provide you with the best service and solution. Let us make a better world for our industry!



## Contact us

Tel: +86-755-8981 8866 Fax: +86-755-8427 6832

Email & Skype: info@chipsmall.com Web: www.chipsmall.com

Address: A1208, Overseas Decoration Building, #122 Zhenhua RD., Futian, Shenzhen, China





**■ Features**

- Universal AC input / Full range (up to 277VAC)
- 2 pole AC inlet IEC320-C8
- Built-in active PFC function
- Constant current design
- Protections: Short circuit
- Cooling by free air convection
- Fully isolated plastic case
- Class II power unit, no FG
- No load power consumption < 0.15W
- Low cost, high reliability
- 100% full load burn-in test
- 3 years warranty

**■ Applications**

- Indoor LED lighting
- Office lighting
- Commercial lighting
- Indoor LED decorative lighting

**■ Description**

GSC40B series is a 40W external desktop LED power supply with PFC function. The design of this product is based on the “plug and play” concept for adaptors. The AC input side exploits the 2-Pin (Class II, no FG) international standard inlet IEC320-C8, and the output side is equipped with the highly accepted DC connector (2.1x5.5x11mm) in the market. This product accepts 90~277VAC input and offers various constant current output models with 350mA/500mA/700mA/1050mA/1400mA. The design complies with the lighting requirements of EMI EN55015 and the harmonic current demand per EN61000-3-2 Class C. In addition, the no load power consumption is less than 0.15W, and the setup time is less than 500ms, making GSC40B conform to the ErP regulation required by European Union for lighting systems as well.

**■ Model Encoding**

**GSC 40 B - 350**

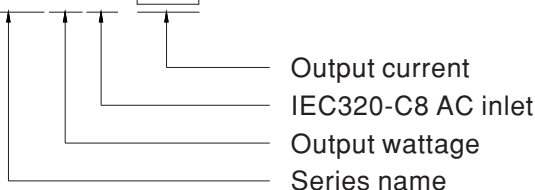

**SPECIFICATION**

MODEL	GSC40B-350	GSC40B-500	GSC40B-700	GSC40B-1050	GSC40B-1400	
OUTPUT	RATED CURRENT	350mA	500mA	700mA	1050mA	1400mA
	OPERATING VOLTAGE RANGE <small>Note.4</small>	50 ~ 100V	40 ~ 80V	29 ~ 58V	19 ~ 38V	14 ~ 28V
	CURRENT ACCURACY <small>Note.3</small>	± 8.0%				
	RATED POWER	35W	40W	40.4W	39.6W	39.2W
	RIPPLE & NOISE (max.) <small>Note.2</small>	11.6Vp-p	8Vp-p	5.8Vp-p	3.8Vp-p	2.9Vp-p
	NO LOAD OUTPUT VOLTAGE (max.)	120V	100V	80V	55V	40V
SETUP TIME	500ms / 230VAC 1000ms / 115VAC at full load					
INPUT	VOLTAGE RANGE	90 ~ 277VAC 127 ~ 392VDC				
	FREQUENCY RANGE	47 ~ 63Hz				
	POWER FACTOR (Typ.)	PF>0.98/115VAC, PF>0.92/230VAC, PF>0.91/277VAC at full load (Please refer to "Power Factor Characteristic" curve)				
	TOTAL HARMONIC DISTORTION	Total harmonic distortion will be lower than 20% when output loading is 75% or higher				
	EFFICIENCY (Typ.)	89.5%	89.5%	88.5%	87.5%	87%
	AC CURRENT (Typ.)	0.7A/115VAC 0.35A/230VAC 0.25A/277VAC				
	INRUSH CURRENT(max.)	COLD START 17A(t <sub>width</sub> =110μs measured at 50% I <sub>peak</sub> ) at 230VAC				
LEAKAGE CURRENT	<0.5mA / 240VAC					
PROTECTION	SHORT CIRCUIT	Hiccup mode, recovers automatically after fault condition is removed.				
ENVIRONMENT	WORKING TEMP.	-30 ~ +50°C (Refer to "Derating Curve")				
	WORKING HUMIDITY	20 ~ 95% RH non-condensing				
	STORAGE TEMP., HUMIDITY	-40 ~ +80°C, 10 ~ 95% RH				
	TEMP. COEFFICIENT	±0.03%/°C (0 ~ 50°C)				
	VIBRATION	10 ~ 500Hz, 2G 12min./1cycle, period for 72min. each along X, Y, Z axes				
SAFETY & EMC	SAFETY STANDARDS	Dekra GS/ENEC EN61347-1, EN61347-2-13 listed, EN62384, GB19510.1, GB19510.14 approved				
	WITHSTAND VOLTAGE	I/P-O/P:3.75KVAC				
	ISOLATION RESISTANCE	I/P-O/P:100M Ohms / 500VDC / 25°C / 70% RH				
	EMC EMISSION	Compliance to EN55015, EN61000-3-2 Class C (≥50% load) ; EN61000-3-3, GB17743, GB17625.1				
	EMC IMMUNITY	Compliance to EN61000-4-2,3,4,5,6,8,11,EN61547, light industry level, criteria A				
OTHERS	MTBF	358.9K hrs min. MIL-HDBK-217F (25°C)				
	DIMENSION	79*54*33mm (L*W*H)				
	PACKING	275g ; 60pcs / 17.5kg / CARTON				
CONNECTOR	PLUG	2.1φ * 5.5φ * 11mm, tuning fork type, center positive for stock				
	CABLE	See page 4				
NOTE	<ol style="list-style-type: none"> <li>All parameters NOT specially mentioned are measured at 230VAC input, rated load and 25°C of ambient temperature.</li> <li>Ripple &amp; noise are measured at 20MHz of bandwidth by using a 12" twisted pair-wire terminated with a 0.1uf &amp; 47uf parallel capacitor.</li> <li>Please see "AC input voltage drop vs. output current characteristics" table.</li> <li>Direct connecting to LEDs is suggested, but is not suitable for using additional drivers.</li> <li>Constant current operation region is within 50% ~100% rated output voltage. This is the suitable operation region for LED related applications, but please reconfirm special electrical requirements for some specific system design.</li> </ol>					



■ **Block Diagram**

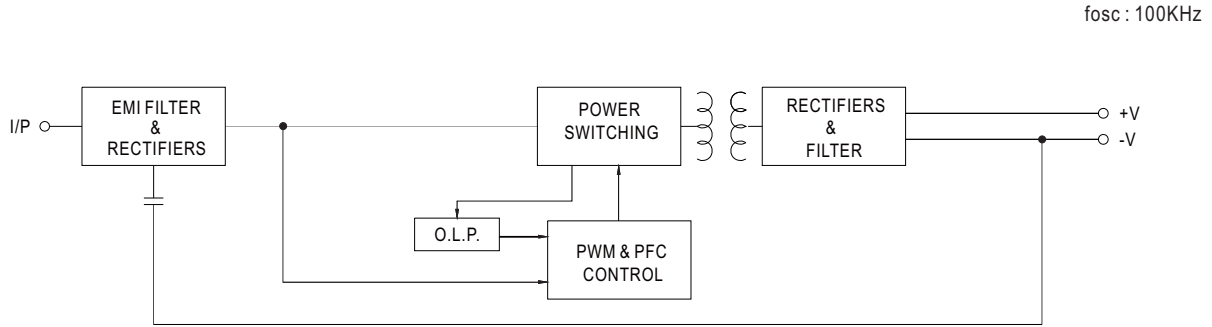

■ **Derating Curve**

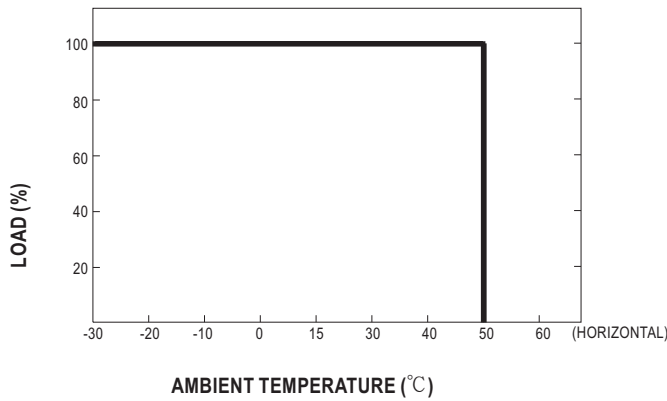

■ **Static Characteristics**

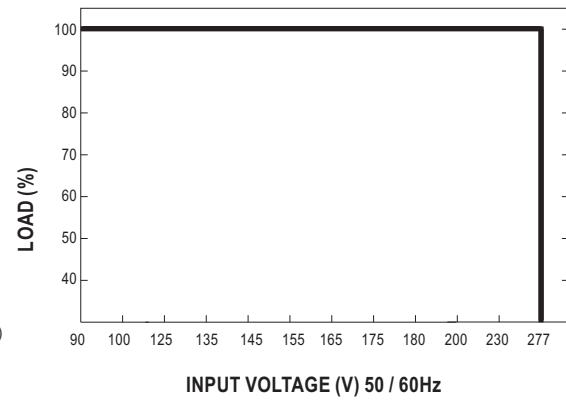

■ **Power Factor Characteristic**

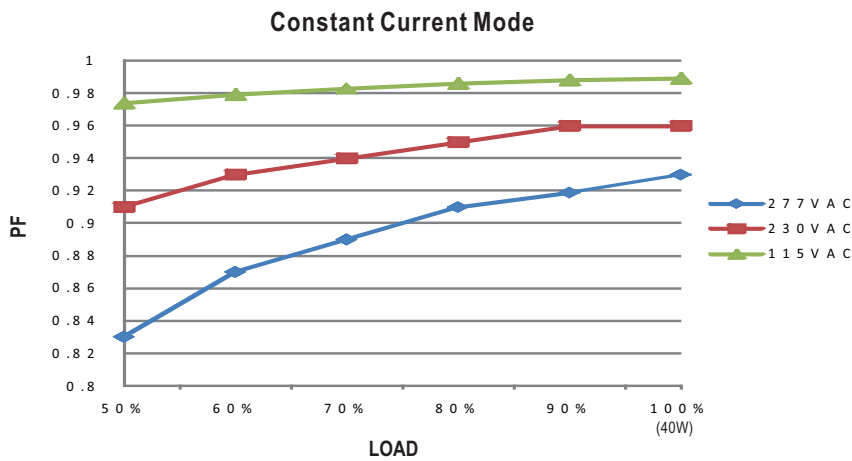

**EFFICIENCY vs LOAD (GSC40B-350)**

GSC40B series possess superior working efficiency that up to 89.5% can be reached in field applications.

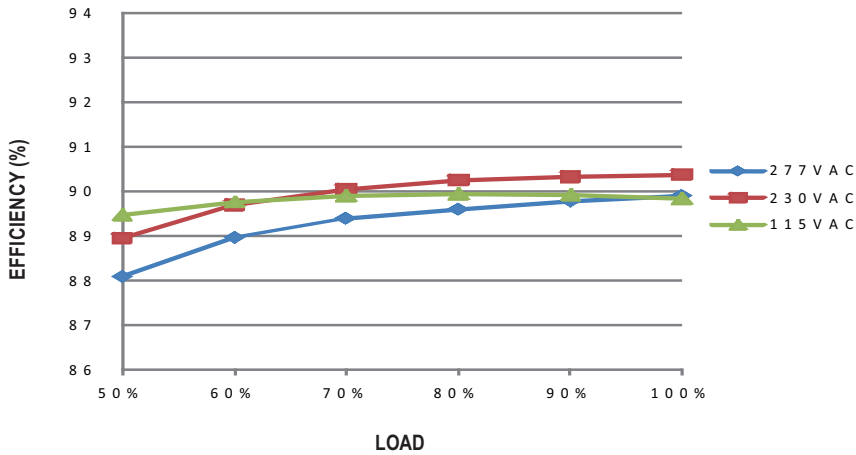

**AC input voltage drop vs. Output current characteristics**

AC input drop	10%	8%	5%	3%
Io drop	<25%	<23%	<15%	<10%

Note : Output current will return to the rated value within 80ms

**Mechanical Specification**

Unit:mm

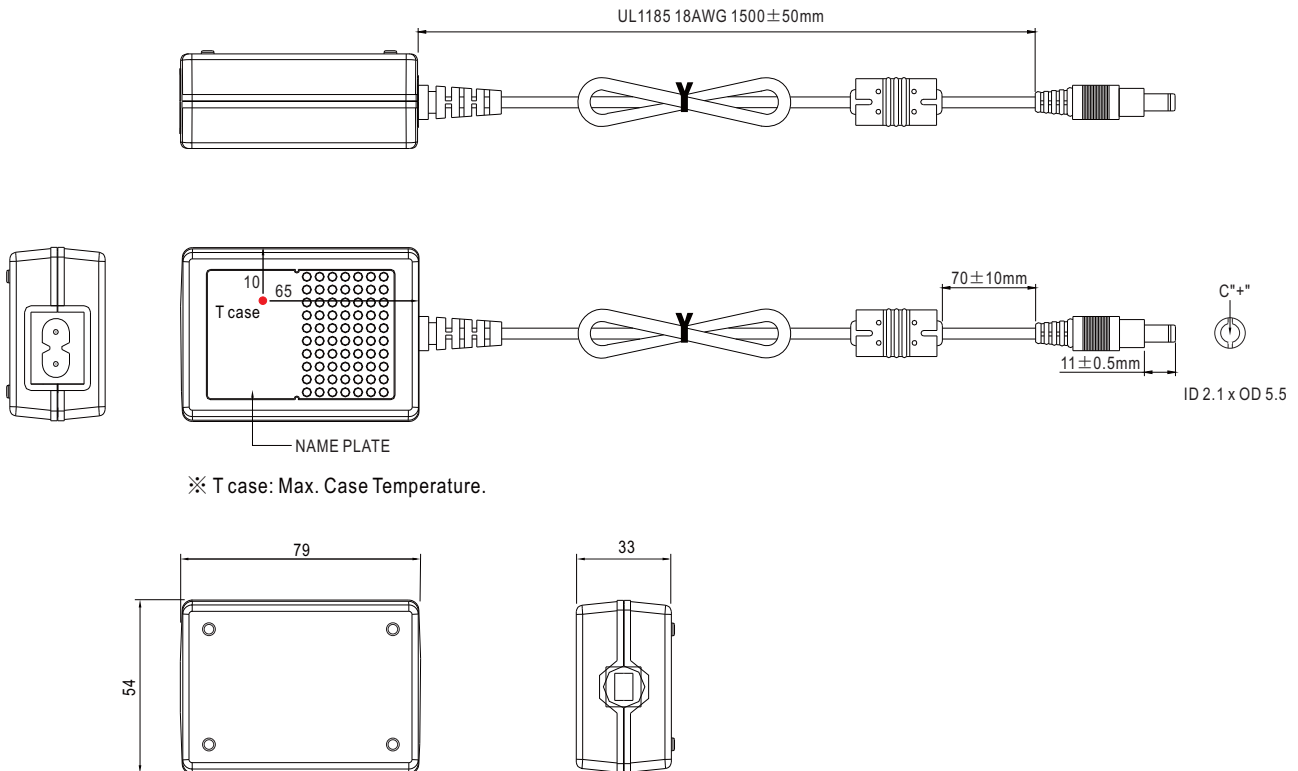

※ T case: Max. Case Temperature.

**Installation Manual**

Please refer to : <http://www.meanwell.com/webnet/search/InstallationSearch.html>