



Chipsmall Limited consists of a professional team with an average of over 10 year of expertise in the distribution of electronic components. Based in Hongkong, we have already established firm and mutual-benefit business relationships with customers from,Europe,America and south Asia,supplying obsolete and hard-to-find components to meet their specific needs.

With the principle of “Quality Parts,Customers Priority,Honest Operation,and Considerate Service”,our business mainly focus on the distribution of electronic components. Line cards we deal with include Microchip,ALPS,ROHM,Xilinx,Pulse,ON,Everlight and Freescale. Main products comprise IC,Modules,Potentiometer,IC Socket,Relay,Connector.Our parts cover such applications as commercial,industrial, and automotives areas.

We are looking forward to setting up business relationship with you and hope to provide you with the best service and solution. Let us make a better world for our industry!



Contact us

Tel: +86-755-8981 8866 Fax: +86-755-8427 6832

Email & Skype: info@chipsmall.com Web: www.chipsmall.com

Address: A1208, Overseas Decoration Building, #122 Zhenhua RD., Futian, Shenzhen, China



GSID150A120S5C1

6-Pack IGBT Module



Features:

- Short Circuit Rated 10 μ s
- Low Saturation Voltage: $V_{CE(sat)} = 1.90V @ I_C = 150A, T_C=25^\circ C$
- Low Switching Loss
- 100% RBSOA Tested ($2 \times I_C$)
- Low Stray Inductance
- Lead Free, Compliant with RoHS Requirement



Applications:

- High Power Converters
- Motor Drivers
- UPS Systems

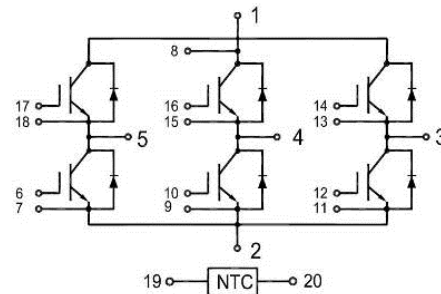

IGBT, Inverter

Maximum Rated Values ($T_C=25^\circ C$ unless otherwise specified)

V_{CES}	Collector-Emitter Blocking Voltage		1200	V
V_{GES}	Gate-Emitter Voltage		± 20	V
I_C	Continuous Collector Current	$T_C = 80^\circ C$	150	A
		$T_C = 25^\circ C$	285	A
$I_{CM(1)}$	Peak Collector Current Repetitive	$T_J = 175^\circ C$	300	A
t_{SC}	Short Circuit Withstand Time		>10	μs
P_D	Maximum Power Dissipation per IGBT	$T_C = 25^\circ C$ $T_{Jmax} = 175^\circ C$	1087	W

Electrical Characteristics of IGBT ($T_C=25^\circ\text{C}$ unless otherwise specified)

Static characteristics

Symbol	Description	Conditions	Min	Typ	Max	Unit
$V_{GE(th)}$	Gate-Emitter Threshold Voltage	$I_C = 1\text{ mA}, V_{CE} = V_{GE}$	5.0	5.5	6.0	V
$V_{CE(sat)}$	Collector-Emitter Saturation Voltage	$I_C = 150\text{A}, V_{GE} = 15\text{V}$	$T_J = 25^\circ\text{C}$	1.9	2.10	V
			$T_J = 125^\circ\text{C}$	2.30		V
			$T_J = 150^\circ\text{C}$	2.30		V
I_{CES}	Collector-Emitter Leakage Current	$V_{GE} = 0\text{V}, V_{CE} = V_{CES}, T_J = 25^\circ\text{C}$			1	mA
I_{GES}	Gate-Emitter Leakage Current	$V_{GE} = \pm 20\text{V}, V_{CE} = 0\text{V}, T_J = 25^\circ\text{C}$			200	nA
C_{ies}	Input Capacitance	$V_{CE} = 25\text{V}, V_{GE} = 0\text{V}, f = 1\text{MHz}$		21.2		nF
C_{oes}	Output capacitance			1.09		nF

Switching Characteristics

$t_{d(on)}$	Turn-on Delay Time	$V_{CC} = 600\text{V}, I_C = 150\text{A}, R_G = 15\Omega, V_{GE} = \pm 15\text{V},$ Inductive Load	$T_J = 25^\circ\text{C}$	735		ns
			$T_J = 125^\circ\text{C}$	720		
			$T_J = 150^\circ\text{C}$	720		
t_r	Rise Time		$T_J = 25^\circ\text{C}$	180		ns
			$T_J = 125^\circ\text{C}$	190		
			$T_J = 150^\circ\text{C}$	195		
$t_{d(off)}$	Turn-off Delay Time		$T_J = 25^\circ\text{C}$	630		ns
			$T_J = 125^\circ\text{C}$	655		
			$T_J = 125^\circ\text{C}$	675		
t_f	Fall Time	$T_J = 25^\circ\text{C}$	170		ns	
		$T_J = 125^\circ\text{C}$	200			
		$T_J = 150^\circ\text{C}$	210			
E_{on}	Turn-on Switching Loss	$T_J = 25^\circ\text{C}$	19.7		mJ	
		$T_J = 125^\circ\text{C}$	23.3			
		$T_J = 150^\circ\text{C}$	24.8			
E_{off}	Turn-off Switching Loss	$T_J = 25^\circ\text{C}$	9.3		mJ	

			$T_J = 125^\circ\text{C}$		12.7		
			$T_J = 150^\circ\text{C}$		14.7		
Q_g	Total Gate Charge		$T_J = 25^\circ\text{C}$		1650		nC
			$T_J = 125^\circ\text{C}$		1665		
			$T_J = 150^\circ\text{C}$		1672		
RBSOA	Reverse Bias Safe Operation Area	$I_C=600\text{A}, V_{CC}=1050\text{V}, V_p=1200\text{V}, R_g = 15\Omega, V_{GE}=+15\text{V to } 0\text{V}, T_J = 150^\circ\text{C}$	Trapezoid				
SCSOA	Short Circuit Safe Operation Area	$V_{CC} < 720\text{V}, V_{GE} = 15\text{V}, T_J = 150^\circ\text{C}$	10				μs
$R_{\theta JC}$	IGBT Thermal Resistance: Junction-To-Case				0.138		$^\circ\text{C/W}$

Diode, Inverter

Maximum Rated Values ($T_C=25^\circ\text{C}$ unless otherwise specified)

V_{RRM}	Repetitive Peak Reverse Voltage	1200	V
I_F	Diode Continuous Forward Current	150	A
I_{FM}	Repetitive Peak Forward Current	300	A

Electrical Characteristics of FWD ($T_C=25^\circ\text{C}$ unless otherwise specified)

Symbol	Description	Conditions	Min	Typ	Max	Unit
V_{FM}	Forward Voltage	$I_F = 150\text{A}, V_{GE} = 0\text{V}$	$T_J = 25^\circ\text{C}$		2.30	V
			$T_J = 125^\circ\text{C}$		2.40	
			$T_J = 150^\circ\text{C}$		2.40	
I_{rr}	Peak Reverse Recovery Current		$T_J = 25^\circ\text{C}$		50	A
			$T_J = 125^\circ\text{C}$		65	
			$T_J = 150^\circ\text{C}$		75	
Q_{rr}	Reverse Recovery Charge	$I_F = 150\text{A}, di/dt = 900\text{A}/\mu\text{s}, V_{rr} = 600\text{V}, V_{GE} = -15\text{V}$	$T_J = 25^\circ\text{C}$		7.3	μC
			$T_J = 125^\circ\text{C}$		14.3	
			$T_J = 150^\circ\text{C}$		18.3	
E_{rec}	Reverse Recovery Energy		$T_J = 25^\circ\text{C}$		2.0	mJ
			$T_J = 125^\circ\text{C}$		4.3	

		T _J = 150°C		5.8	
R _{θJC}	Diode Thermal Resistance: Junction-To-Case			0.253	°C/W

Internal NTC-Thermistor Characteristics

Symbol	Description	Min	Typ	Max	Unit
R ₂₅	T _C =25°C		5		kΩ
ΔR/R	T _C =100°C, R ₁₀₀ =481Ω			±5	%
P ₂₅	T _C =25°C		50		mW
B _{25/50}	$R_2=R_{25} \exp[B_{25/50}(1/T_2-1/(298.15K))]$		3380		K
B _{25/80}	$R_2=R_{25} \exp[B_{25/80}(1/T_2-1/(298.15K))]$		3440		K

Module

Symbol	Description	Min	Typ	Max	Unit
V _{iso}	Isolation Voltage(All Terminals Shorted) f = 50Hz, 1minute	2500			V
T _J	Maximum Junction Temperature			175	°C
T _{JOP}	Maximum Operating Junction Temperature Range	-40		+150	°C
T _{stg}	Storage Temperature	-40		+125	°C
R _{θCS}	Case-To-Sink (Conductive Grease Applied)		0.02		°C/W
M	Mounting Screw:M5	3.0		6.0	N·m
M	Power Terminals Screw: M6	3.0		6.0	N·m
G	Weight		390		g

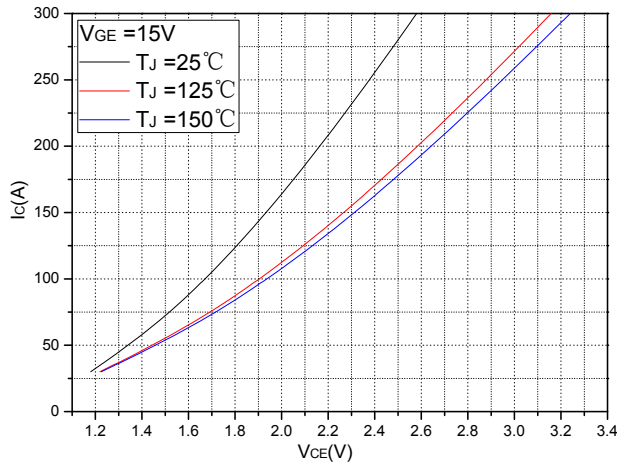

Fig.1 Typical Saturation Voltage Characteristics

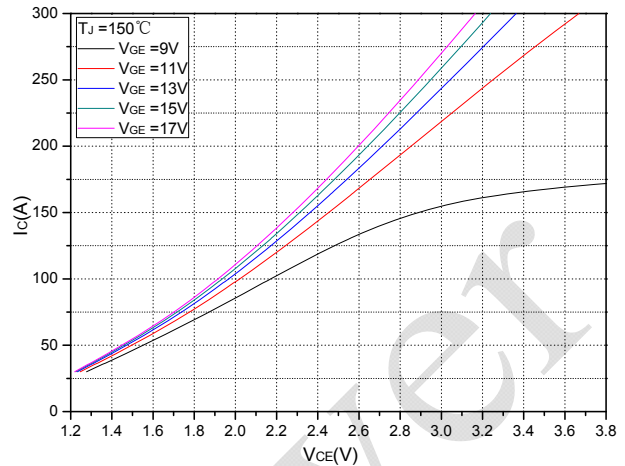

Fig.2 Typical Output Characteristics

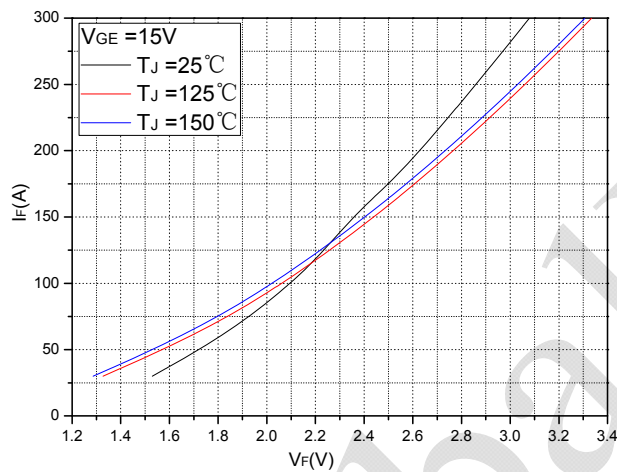

Fig.3 Forward Characteristics of FWD

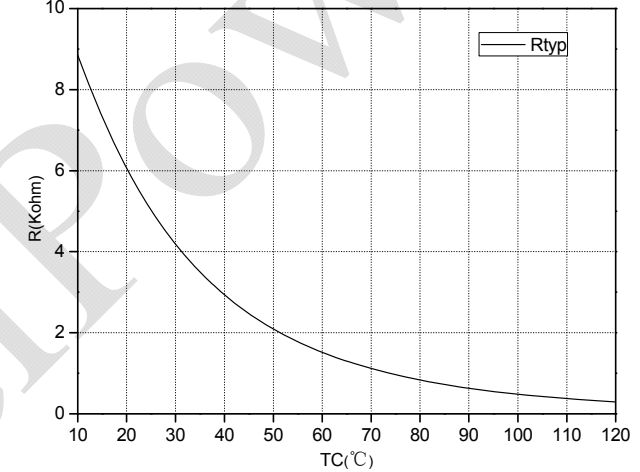

Fig.4 NTC Temperature characteristics

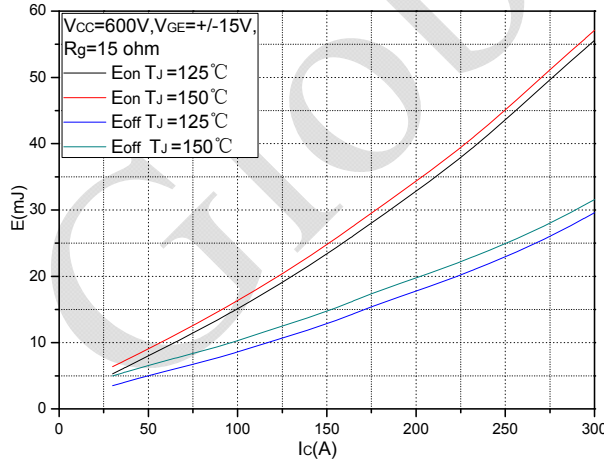

Fig.5 Typical Switching Loss vs. Collector Current

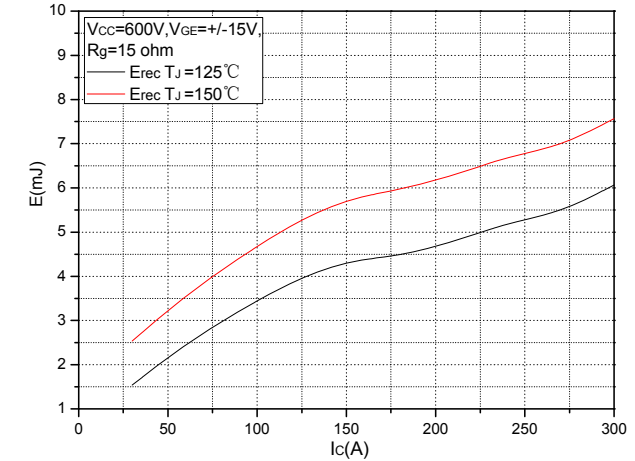

Fig.6 Typical Switching Loss vs. Collector Current

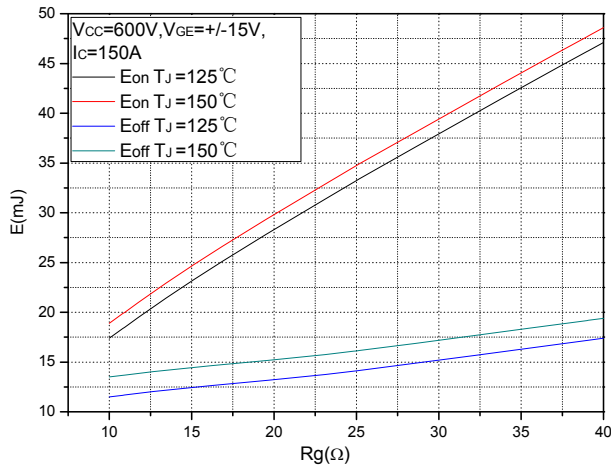

Fig.7 Typical Switching Loss vs. Gate Resistance

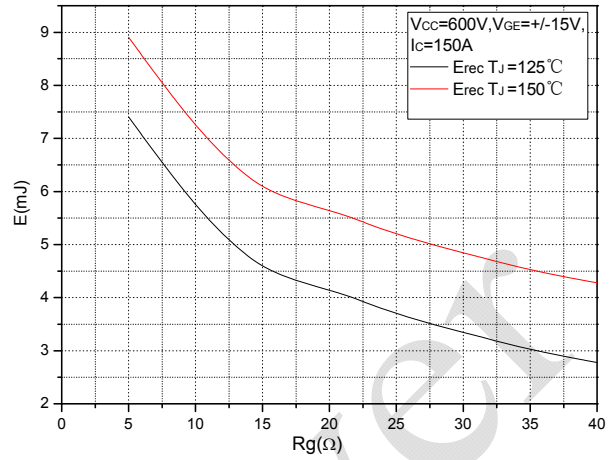

Fig.8 Typical Switching Loss vs. Gate Resistance

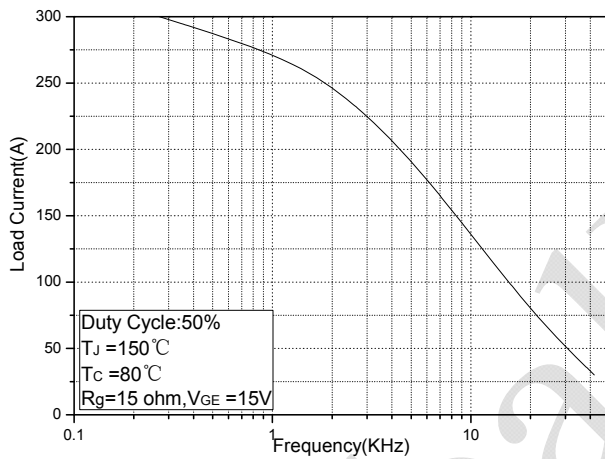

Fig.9 Typical Load Current vs. Frequency

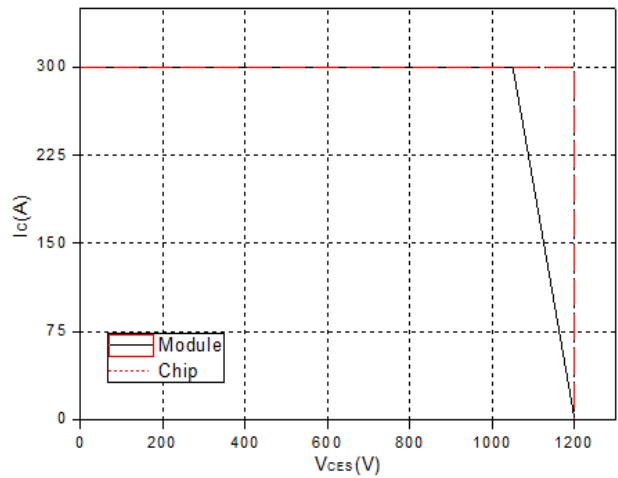

Fig.10 Reverse Bias Safe Operation Area (RBSOA)

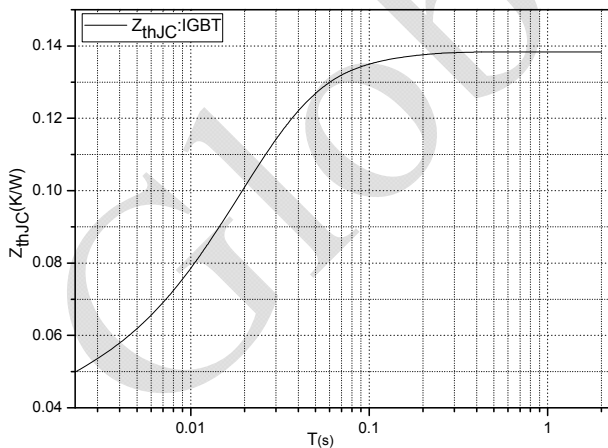

Fig.11 Transient thermal impedance (IGBT)

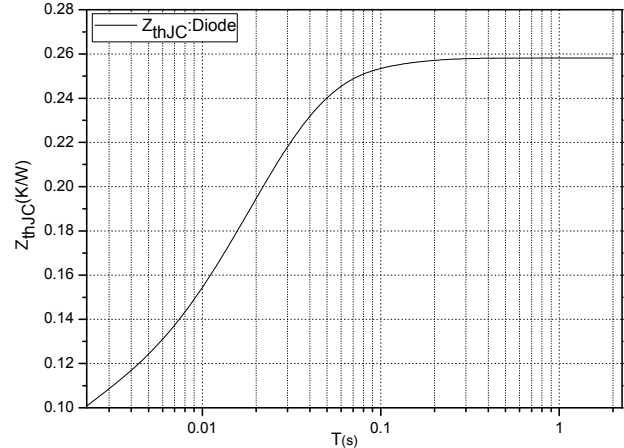

Fig.12 Transient thermal impedance (Diode)

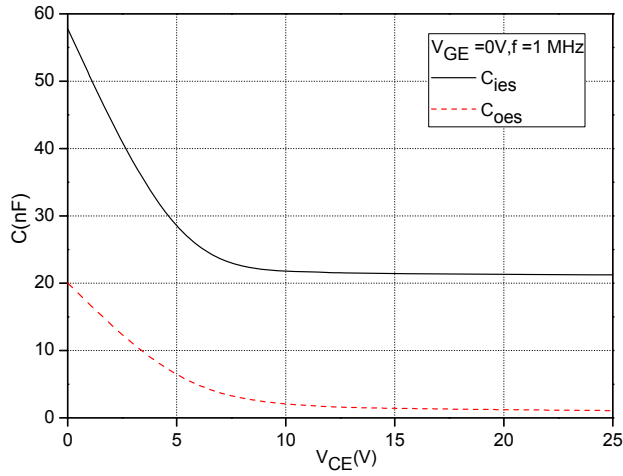
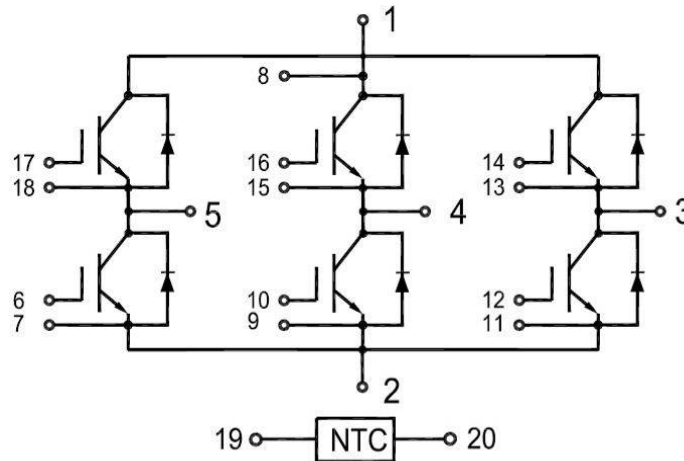

Fig.13 Capacitance Characteristics

GlobalPower

Internal Circuit



Package Outline (Unit: mm):

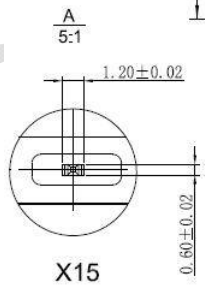
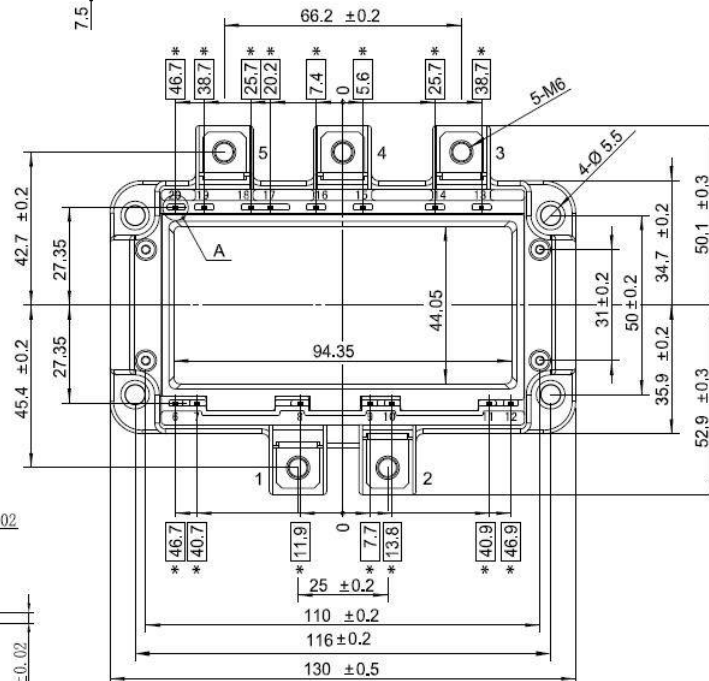
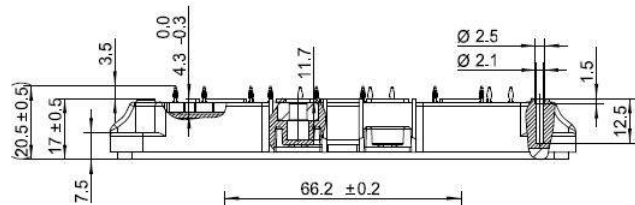
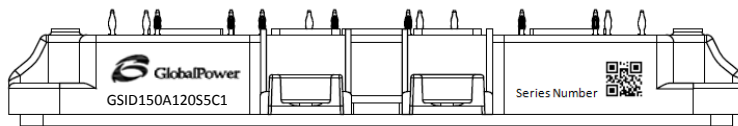

*=all dimensions with tolerance of ± 0.4

Revision History

Date	Revision	Notes
10/23/2015	0.1	Initial release of preliminary datasheet
11/15/2015	0.2	Add the test data at junction temperature of 150°C.

Global Power Technologies Group

20692 Prism Place
 Lake Forest, CA 92630
 TEL (949) 207-7500
 FAX (949) 613-7600
 E-mail: info@gptechnology.com
 Web site: www.gptechnology.com



Notes

- RoHS Compliance**
 The levels of RoHS restricted materials in this product are below the maximum concentration values (also referred to as the threshold limits) permitted for such substances, or are used in an exempted application, in accordance with EU Directive 2011/65/EC (RoHS2), as implemented March, 2013. RoHS Declarations for this product can be obtained from the Product Documentation sections of www.gptechnology.com.
- REACH Compliance**
 REACH substances of high concern (SVHCs) information is available for this product. Since the European Chemical Agency (ECHA) has published notice of their intent to frequently revise the SVHC listing for the foreseeable future, please contact our office at GPTG Headquarters in Lake Forest, California to insure you get the most up-to-date REACH SVHC Declaration.
 REACH banned substance information (REACH Article 67) is also available upon request.
- This product has not been designed or tested for use in, and is not intended for use in, applications implanted into the human body nor in applications in which failure of the product could lead to death, personal injury or property damage, including but not limited to equipment used in the operation of nuclear facilities, life-support machines, cardiac defibrillators or similar emergency medical equipment, aircraft navigation or communication or control systems, or air traffic control.
- To obtain additional technical information or to place an order for this product, please contact us. The information in this datasheet is provided by Global Power Technologies Group. GPTG reserves the right to make changes, corrections, modifications, and improvements of datasheet without notice.