



Chipsmall Limited consists of a professional team with an average of over 10 year of expertise in the distribution of electronic components. Based in Hongkong, we have already established firm and mutual-benefit business relationships with customers from,Europe,America and south Asia,supplying obsolete and hard-to-find components to meet their specific needs.

With the principle of “Quality Parts,Customers Priority,Honest Operation,and Considerate Service”,our business mainly focus on the distribution of electronic components. Line cards we deal with include Microchip,ALPS,ROHM,Xilinx,Pulse,ON,Everlight and Freescale. Main products comprise IC,Modules,Potentiometer,IC Socket,Relay,Connector.Our parts cover such applications as commercial,industrial, and automotives areas.

We are looking forward to setting up business relationship with you and hope to provide you with the best service and solution. Let us make a better world for our industry!



Contact us

Tel: +86-755-8981 8866 Fax: +86-755-8427 6832

Email & Skype: info@chipsmall.com Web: www.chipsmall.com

Address: A1208, Overseas Decoration Building, #122 Zhenhua RD., Futian, Shenzhen, China



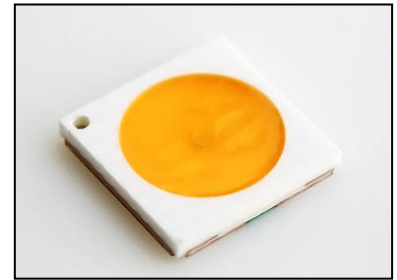

Features

| | |
|------------------|--|
| Package | Silicone Package type Outer dimension 4.6 x 4.6 x 0.67mm (L x W x H) |
| Product features | <ul style="list-style-type: none"> • Efficiency 76lm/W @350mA • White color emitting LED (Color Temperature 3,000K) • General Color Rendering Index : Ra95 • Low Thermal resistance product 9°C/W • Lead-free soldering compatible • RoHS compliant |

Recommended Applications

- Outdoor lighting : Road lighting, Tunnel lighting, Crime prevention lighting
- Indoor lighting : Facility lighting (museum etc.) that make use of high color rendering, Residential lighting, Store lighting, Office lighting, Plant lighting, other general lighting

Outline Dimensions

GSPW1651NSE-30Z-TR

Unit : mm
 Weight : 28.5mg
 Tolerance : ±0.1

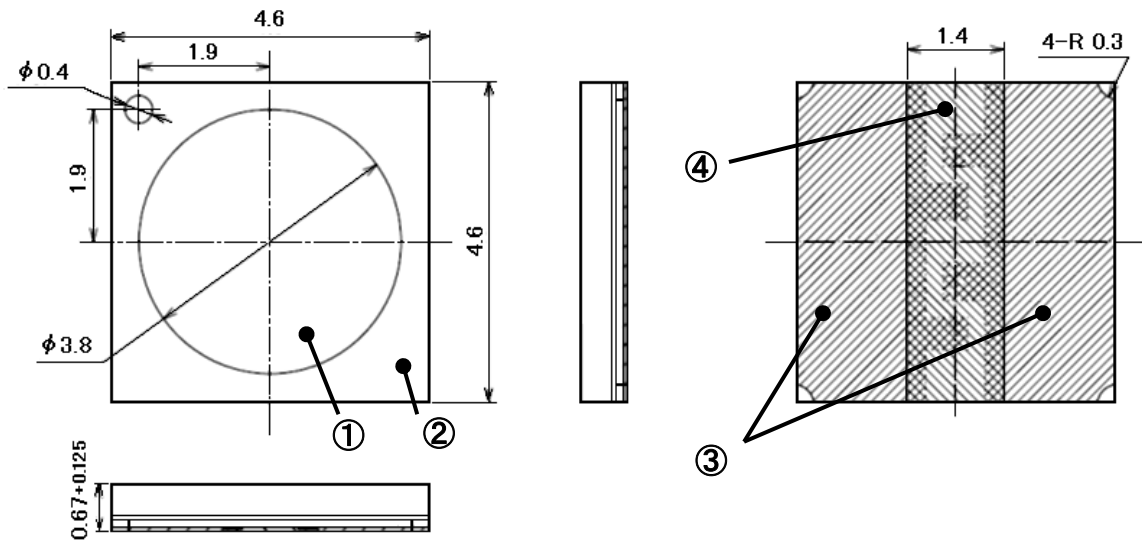

【Inside Circuit】

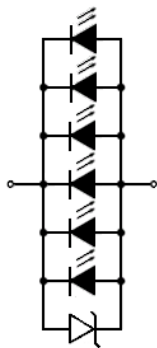

| No. | Part Name | Material | QTY. |
|-----|------------------|----------------|------|
| — | LED Die | InGaN | 6 |
| | Protection Diode | Si | 1 |
| ① | Encapsulant | Silicone Resin | 1 |
| ② | Lamp housing | Silicone Resin | 1 |
| ③ | Electrode | Ag Plating | 2 |
| ④ | Solder resist | Resin | 1 |

Recommended Soldering Pattern

Unit : mm

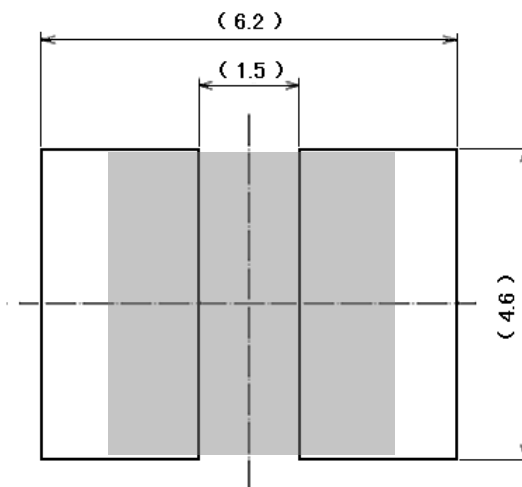

Specifications

GSPW1651NSE-30Z-TR

【 Product Overview 】

| | |
|-----------------------------|----------------------|
| Die Material | InGaN |
| Emitting Color | White |
| Resin Color 【Emitting Area】 | Diffused Pale Orange |
| Lamp Housing Color | White |

【 Absolute Maximum Ratings 】

| ITEM | SYMBOL | MAXIMUM RATINGS | UNITS | |
|--|--------------|-----------------|-------|---------|
| Power Dissipation | P_d | 2,310 | mW | |
| Forward Current | I_F | 600 | mA | |
| I_F Derate Linearly from "Ts=90°C" | ΔI_F | 20 | mA/°C | Notes 1 |
| Allowable Reverse Current | I_R | 85 | mA | |
| Operating Temperature | T_{opr} | -30 ~ +85 | °C | |
| Storage Temperature | T_{stg} | -30 ~ +100 | °C | Notes 2 |
| Electrostatic Discharge Threshold "HBM" | ESD | 1,000 | V | Notes 2 |
| Soldering Temperature "Reflow Soldering" | T_{sld} | 260 | °C | Notes 4 |

Notes 1 Junction - solder point (measurement point)

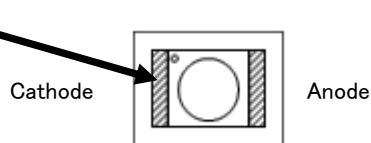

Notes 2 The range of operating and storage temperature is not taping condition.

Notes 3 ESD testing method: EIAJ4701/300(304) HBM 1.5KΩ, 100pF

Noted 4 Please refer to attached sheets soldering conditions.

【 Thermal Characteristics 】

| ITEM | SYMBOL | MIN. | TYP. | MAX. | UNITS | |
|---|---------------|------|------|------|-------|---------|
| Thermal resistance 【Junction - solder point】 | $R_{th(j-s)}$ | - | 9 | - | °C/W | Notes 3 |

【 Electro-Optical Characteristics 】

(Ts=25°C)

| ITEM | SYMBOL | CONDITIONS | MIN. | TYP. | MAX. | UNITS | |
|-------------------------------|-------------------|----------------------|------|-------|------|-------|-----------|
| Forward Voltage | V_F | $I_F = 350\text{mA}$ | 2.75 | 3.00 | 3.50 | V | |
| Reverse Voltage | V_R | $I_R = 10\text{mA}$ | 0.6 | - | 1.1 | V | Notes 5 |
| Luminous Flux | Φ_V | $I_F = 350\text{mA}$ | 60 | 80 | 100 | lm | Notes 6 |
| Luminous Flux 【@85°C】 | Φ_V | $I_F = 350\text{mA}$ | - | 69 | - | lm | Notes 7 |
| Efficiency | - | $I_F = 350\text{mA}$ | - | 76 | - | lm/W | |
| Chromaticity Coordinates | x | $I_F = 350\text{mA}$ | - | 0.434 | - | | Notes 8,9 |
| | y | $I_F = 350\text{mA}$ | - | 0.403 | - | | |
| Half Intensity Angle | $\Delta \theta_x$ | $I_F = 350\text{mA}$ | - | 115 | - | deg. | Notes 10 |
| | $\Delta \theta_y$ | | - | 115 | - | | |
| General Color Rendering Index | Ra | $I_F = 350\text{mA}$ | - | 95 | - | | |
| Color Temperature | - | $I_F = 350\text{mA}$ | - | 3,000 | - | K | |

Notes 5 Please do not input reverse voltage for prevent the destruction by static electricity.

Notes 6,8 Please refer to the attached sheets, each sorting chart.

Notes 7 Luminous flux at 85°C(junction temperature)

Notes 9 Chromaticity coordinates : x and y according to CIE1931.

Notes 10 Viewing Angle at 50% I_V , $\Delta \theta_x$, θ_y , as shown in the right side figure.

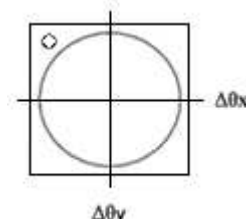

【 Sorting Chart for Luminous Flux Φ_V 】

LEDs shall be sorted out into the following chart and each rank parts shall be pscked separately when shipping.

(Ts=25°C)

| Rank | Luminous Flux Φ_V (lm) | | Condition |
|------|-----------------------------|------|----------------------|
| | MIN. | MAX. | |
| MA | 60 | 80 | $I_F = 350\text{mA}$ |
| MB | 80 | 100 | |

Notes Tolerance each rank : ±10%

【 Sorting chart For Chromaticity coordinates 】

Chromaticity coordinates shall be sorted out into the following chart and each rank parts shall be packed separately when shipping.

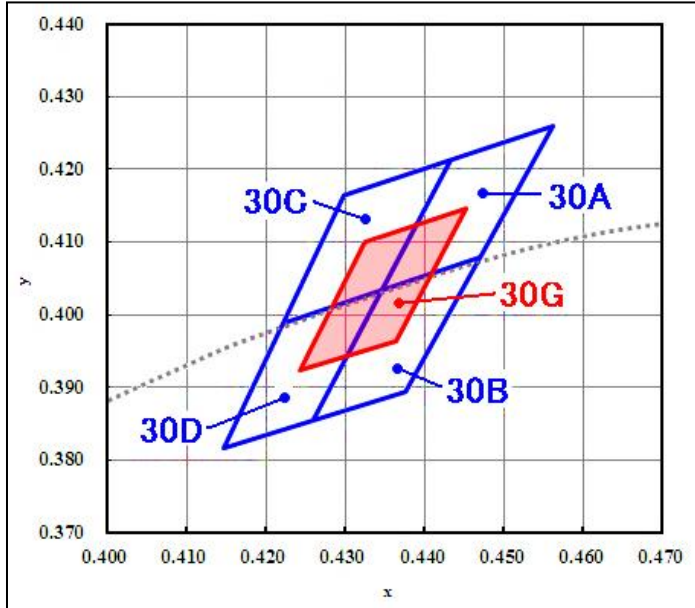
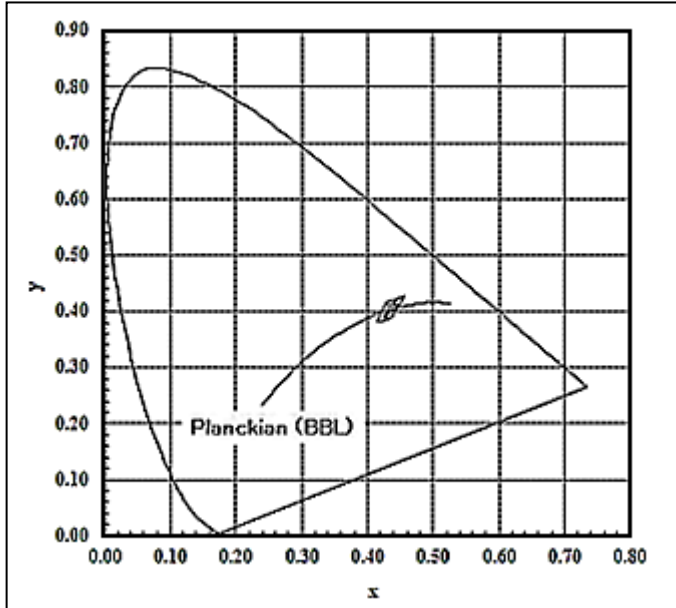

| |
|---------------------------|
| General color temperature |
| 3,000K (2,870K~3,220K) |

(Ts=25°C If=350mA)

| Rank | x | y | Rank | x | y | Rank | x | y | Rank | x | y |
|------|--------|--------|------|--------|--------|------|--------|--------|------|--------|--------|
| 30A | 0.4345 | 0.4033 | 30B | 0.4260 | 0.3854 | 30C | 0.4223 | 0.3990 | 30D | 0.4147 | 0.3814 |
| | 0.4431 | 0.4213 | | 0.4345 | 0.4033 | | 0.4299 | 0.4165 | | 0.4223 | 0.3990 |
| | 0.4562 | 0.4260 | | 0.4468 | 0.4077 | | 0.4431 | 0.4213 | | 0.4345 | 0.4033 |
| | 0.4468 | 0.4077 | | 0.4373 | 0.3893 | | 0.4345 | 0.4033 | | 0.4260 | 0.3854 |

| Rank | x | y |
|------|--------|--------|
| 30G | 0.4244 | 0.3923 |
| | 0.4324 | 0.4100 |
| | 0.4451 | 0.4146 |
| | 0.4361 | 0.3964 |

Notes

- Chromaticity coordinates Tolerance each rank : ±0.01
- Chromaticity rank will ship by 5 ranks (A, B, C, D, and G).
- Rank G might also be shipped as Rank A,B,C or D.

【 Sorting chart for Forward Voltage Characteristics, V_F 】

Forward Voltage shall be sorted out into the following chart and each rank parts shall be packed separately when shipping.

($T_s=25^{\circ}\text{C}$)

| Rank | V_F (V) | | Condition |
|------|-----------|------|----------------------|
| | MIN. | MAX. | |
| A | 2.75 | 3.00 | $I_F = 350\text{mA}$ |
| B | 3.00 | 3.25 | |
| C | 3.25 | 3.50 | |

Note: Tolerance each Rank: $\pm 0.1\text{V}$

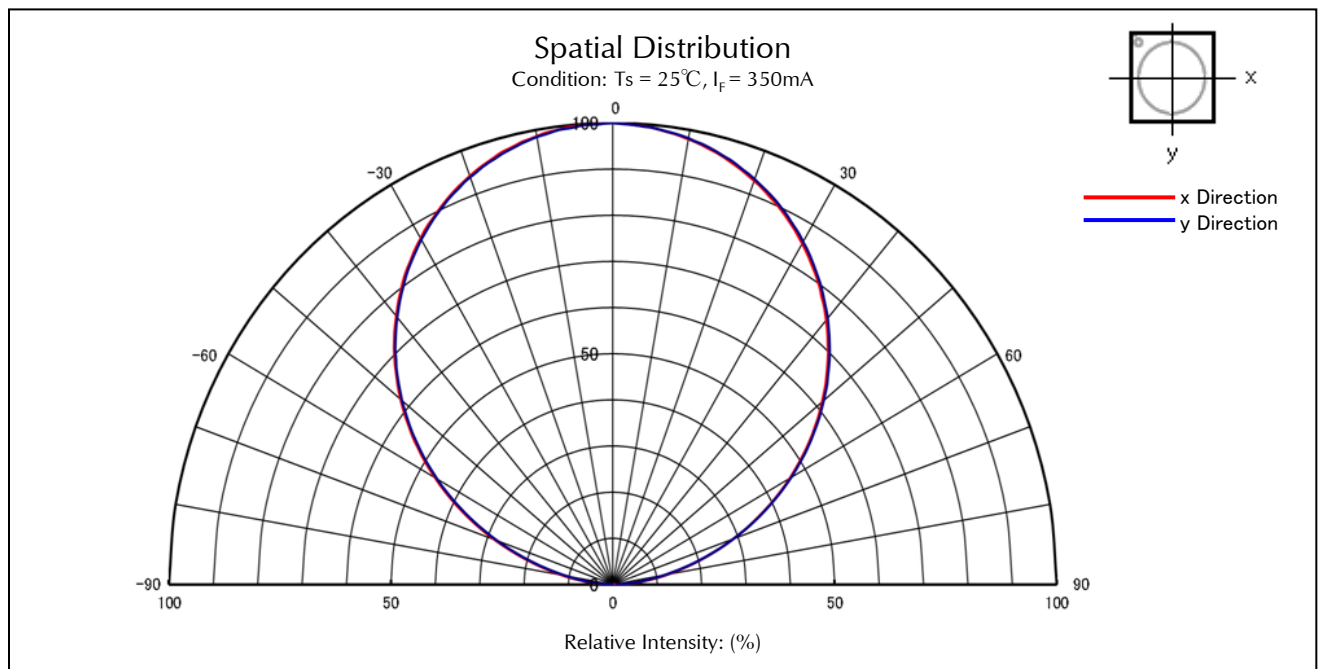
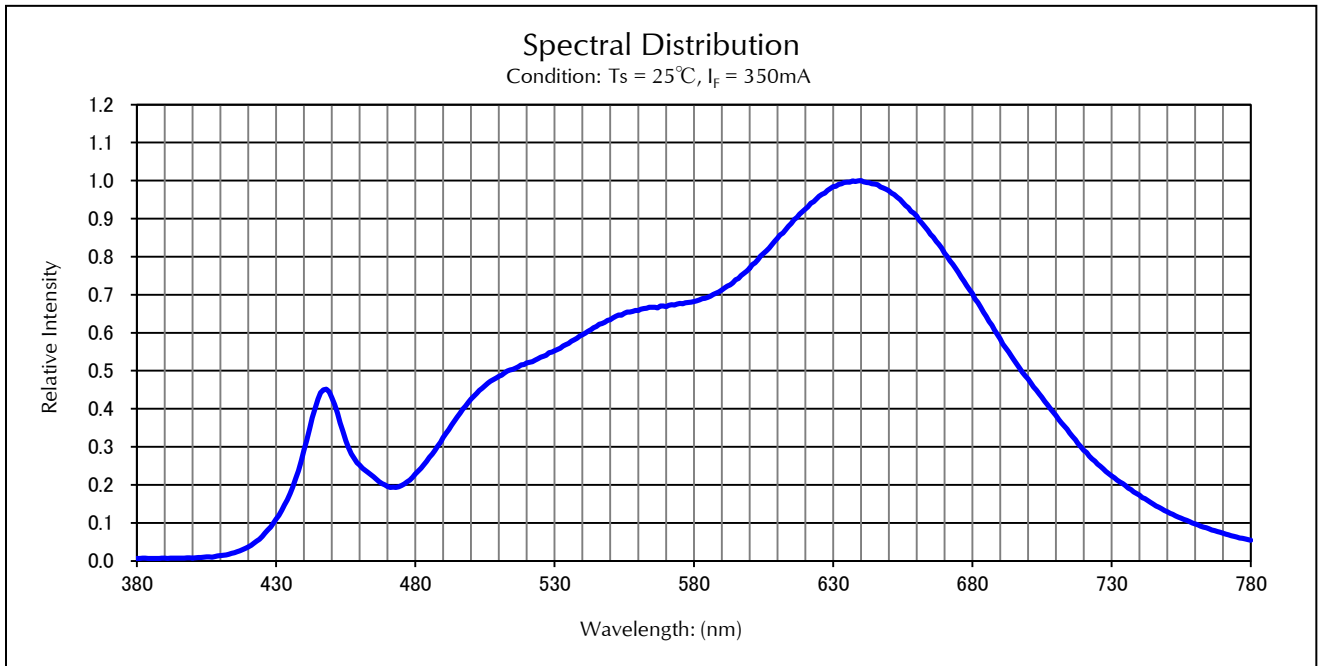

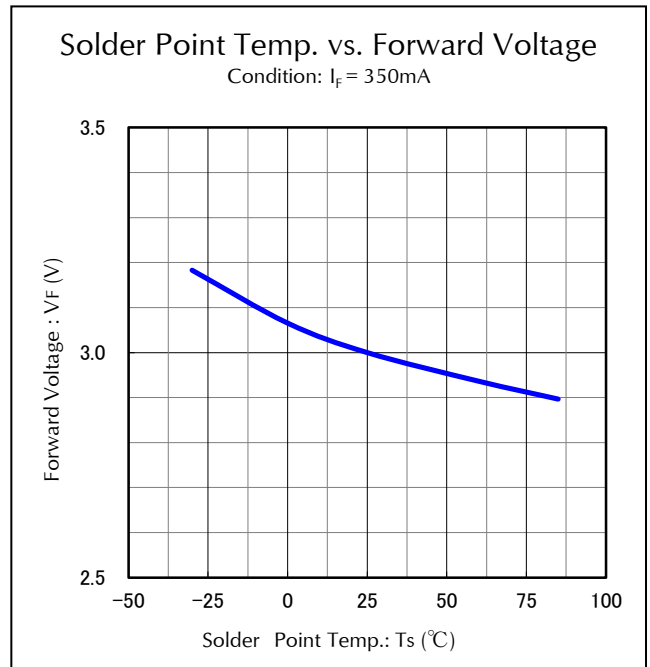
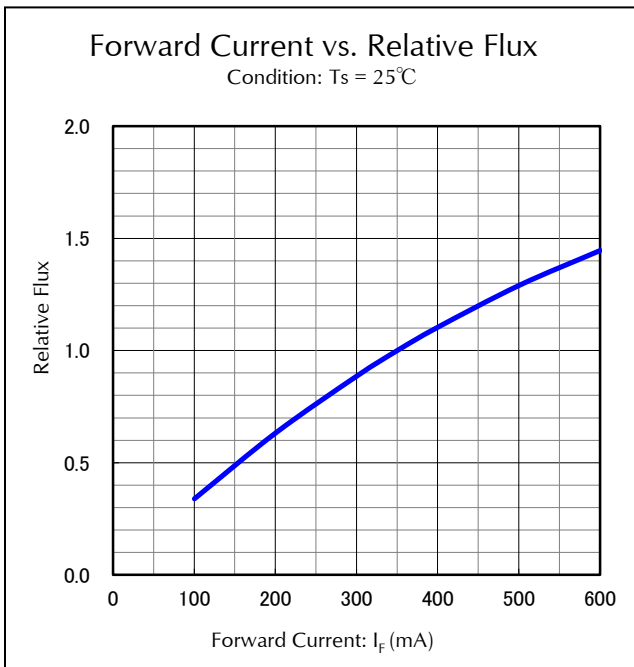
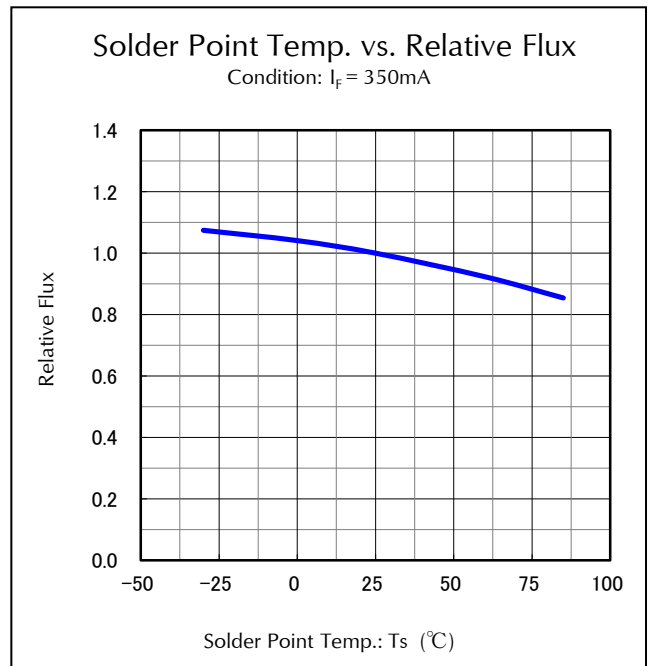
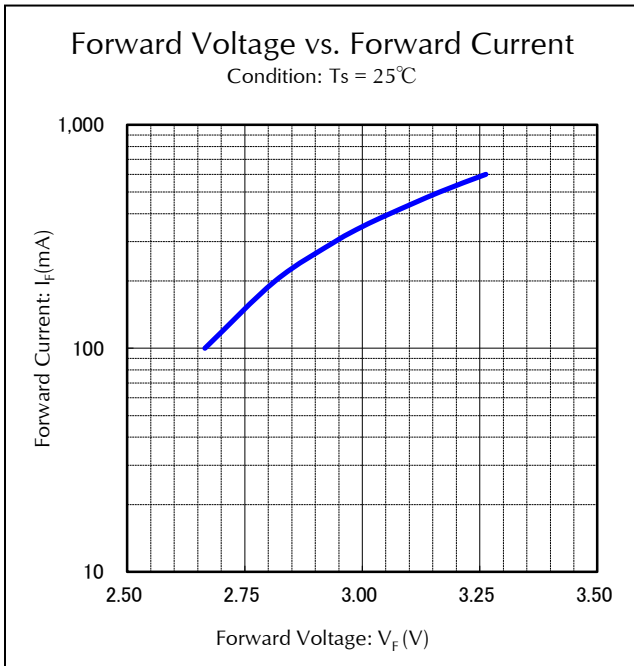

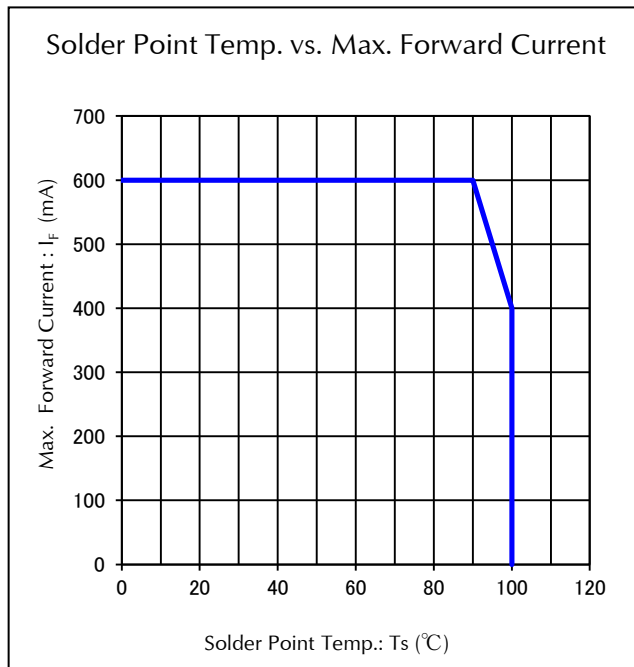
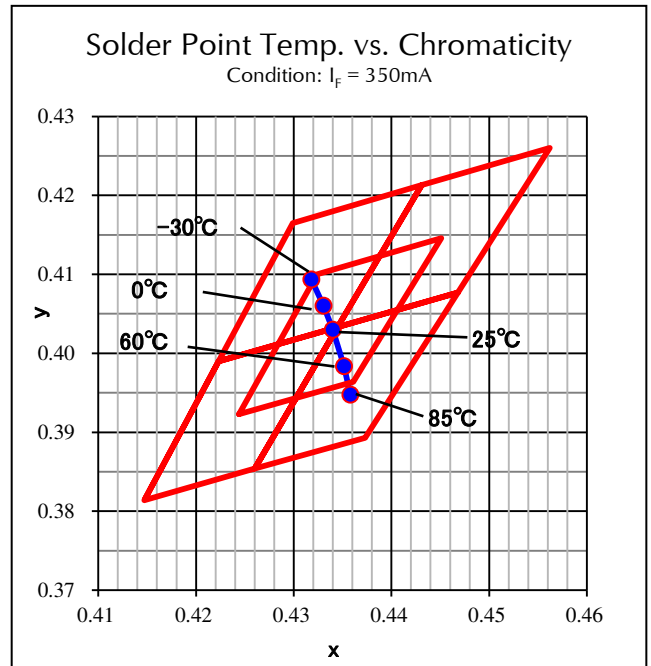
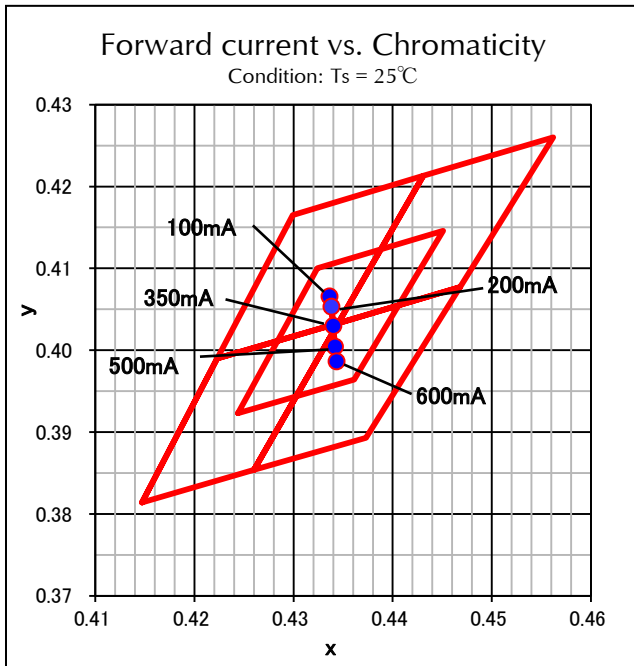

【Soldering Precaution】

(acc.to EIAJ-4701/300)

1. Heat stress during soldering will influence the reliability of LEDs, however that effect will vary on heating method. Also, if components of varying shape are soldered together, it is recommended to set the soldering pad temperature according to the component most vulnerable to heat (e.g., surface mount LED).
2. LED parts including the resin are not stable immediately after soldering (when they are not at room temperature), any mechanical stress may cause damage to the product. Please avoid such stress after soldering, especially stacking of the boards which may cause the boards to warp and any other types of friction with hard materials.
3. Recommended temperature profile for the Reflow soldering is listed as the temperature of the resin surface. Temperature distribution varies on heating method, PCB material, other components in the assembly, and mounting density .
Please do not repeat the heating process in Reflow process more than twice.

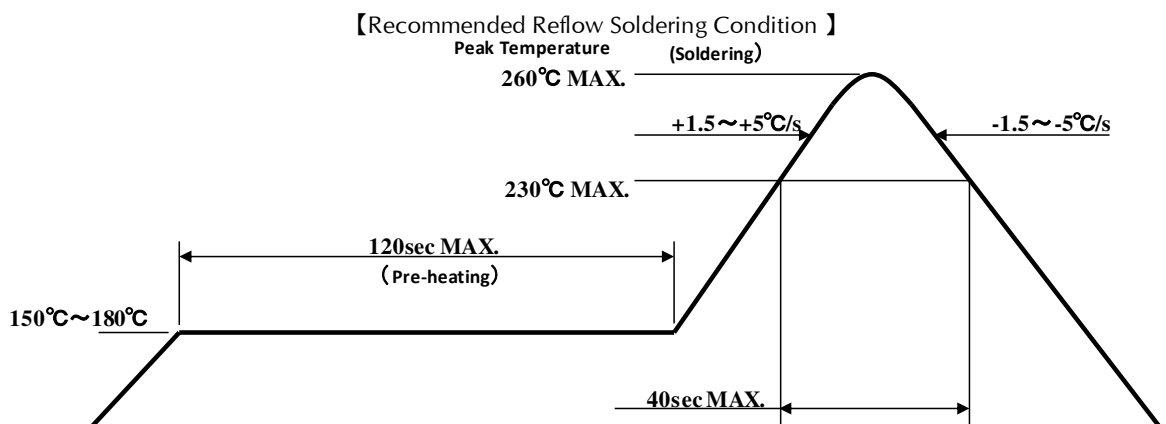

Note 1 Temperature Profile for the reflow should be set to the surface temperature of resin which is on the top of LED. This should be the maximum temperature for soldering. Lowering the heating temperature and decreasing heating time is very effective in achieving higher reliability.

Note 2 The reflow soldering process should be done up to twice(2 times Max). When second process is performed, interval between first and second process should be as short as possible to prevent absorption of moisture to resin of LED. The second soldering process should not be done until LEDs have returned to room temperature (by nature-cooling) after first soldering process.

4. If soldering manually, Stanley recommends using a soldering iron equipped with temperature control. During the actual soldering process, make sure that the soldering iron never touches the LED itself, and avoid the LED's electrode heating temperature reaching above the heating temperature of the solder pad. All repairs must be performed only once in the same spot, and please avoid reusing components.
5. In soldering process, immediately after iron tip is cleaned, please make sure that the soldering iron reaches the appropriate temperature before using. Also, please avoid applying any types of pressure to the soldered components before the solder has been cooled and hardened, as it may deteriorate solder performance and solder quality.

【Recommended Manual Soldering Condition】

| | |
|--------------------------|--------------------|
| Temperature of Iron Tip | 350°C MAX. |
| Soldering Duration, Time | 3sec. Max., 1 time |

6. When using adhesive material for tentative fixatives, thermosetting resin or Ultraviolet radiation (UV) setting resin with heat shall be recommended.
《The curing condition, Temperature:150°C Max./Time:300sec. Max.》
7. Flow soldering (dip soldering) is not recommended for this product.
8. Isopropyl alcohol is recommended for cleaning. Some chemicals, including Freon substitute detergent could corrode the lens or the casing surface, which cause discoloration, cloud, crack and so on. Please review the reference chart below for cleaning. If water is used to clean (including the final cleaning process), please use pure water (not tap water), and completely dry the component. Cleaning with ultrasonic is not recommended.

| Chemical | Adaptability |
|-------------------|--------------|
| Ethyl Alcohol | ○ |
| Isopropyl Alcohol | ○ |
| Pure Water | ○ |
| Trichloroethylene | × |
| Chloroethene | × |
| Acetone | × |
| Thinner | × |

【For Electric Static Discharge (ESD)】

This type of LED lamp is highly sensitive to surge voltage generated by the On/Off status change and discharges of static electricity through frictions with synthetic materials, which may cause severe damage to the die or undermine its reliability. Damaged products may experience conditions such as extremely high reverse voltage, or a decrease of forward rise voltage, deteriorating its optical characteristic.

Stanley products are designed to withstand up to 1,000V under the EIAJ ED-4701/300 Test #304 (HBM), and are packed with anti-static components. However, the following precautions and measures are vital in ensuring product quality during shipment.

EIAJ ED-4701/300(304/HBM) Electrification model: C=100pF, R2=1.5KΩ

1. Electrification/Static Electricity protection

Stanley recommends the following precautions in order to avoid product (die) damage from static electricity , when an operator and other materials electrified by friction coming in contact with the product.

- ① Do not place electrified non-conductive materials near the LED product.
Avoid LED products from coming into contact with metallic materials.(Should the metallic material be electrified , the sudden surge voltage will most likely damage the product.)
- ② Avoid a working process which may cause the LED product to rub against other materials.
- ③ Install ground wires for any equipment, where they can be installed, with measures to avoid static electricity surges.
- ④ Prepare a ESD protective area by placing a Conductive Mattress (1MΩ MAX.) and Ionizer to remove any static electricity.
- ⑤ Operators should wear a protective wrist-strap.
- ⑥ Operators should wear conductive work-clothes and shoes.
- ⑦ To handle the products directly, Stanley recommends the use of ceramic, and not metallic, tweezers.

2. Working Environment

- ① A dry environment is more likely to cause static electricity. Although a dry environment is ideal for storage state of LED products, Stanley recommends an environment with approximately 50% humidity after the soldering process.
- ② Recommended static electricity level in the working environment is 150V, which is the same value as Integrated Circuits (which are sensitive to static electricity).

【Other Precautions】

1. Stanley LED Lamps have semiconductor characteristics and are designed to ensure high reliability. However, the performance may vary depending on usage conditions.
2. Absolute Maximum Ratings are set to prevent LED lamps from failing due to excess stress(temperature, current, voltage, etc.). Usage conditions must not exceed the ratings for a moment, nor do reach one item of absolute maximum ratings simultaneously.
3. In order to ensure high reliability from LED Lamps, variable factors that arise in actual usage conditions should be taken it to account for designing. (Derating of TYP., MAX Forward Voltage, etc.)
4. Please insert Straight Protective Resistors into the circuit in order to stabilize LED operation and to prevent the device from igniting due to excess current.
5. This type of product is not water proof and moisture proof nor with salt corrosion protection , therefore attention should be paid when products are used under such conditions.
6. Please avoid the stick of foreign material because molding resin in the products have adhesiveness.
7. Please check the actual performance in the assembly because the Specification Sheets are described for LED device only.
8. Please refrain from looking directly at the light source of LED at high output, as it may harm your vision.
9. The products are designed to operate without failure in recommended usage conditions. However, please take the necessary precautions to prevent fire, injury, and other damages should any malfunction or failure arise.
10. When there is a process of supersonic wave welding etc. after mounting the product, there is a possibility of affecting on the reliability of junction part in package (junction part of die bonding and wire bonding). Please make sure there is no problem before using.
11. Please avoid overload to the product when using tweezers to pick up LEDs. Overload might cause deformation, disconnection, crap and consequently lead to lighting failure. Tweezers with flat tips is recommended, please avoid using tweezers with sharp tips.
12. Low hardness resin is used on the bottom of lens. Please avoid overload to the surface of lens which might cause wire disconnection and breakage. Be careful when dealing with the products and pay attention to following points.
 - During mounting process, keep lens from coming in contact with adsorbing nozzle and refer to precautions on next page.
 - Pay attention to the storage of LEDs even after mounting, because overload caused by stacking PCBs and shock.
 - In the processes of water pressure during cleaning, air pressure, drying and other processes after mounting , overload to lends should be avoided.
13. The products are manufactured to be used for ordinary electronic equipment. Please contact our sales staff beforehand when exceptional quality and reliability are required, and the failure or malfunction of the products might directly jeopardize life or health (such as for airplanes, aerospace, transport equipment, medical applications, nuclear reactor control systems and so on).
14. The formal specification sheets shall be valid only by exchange of documents signed by both parties.

【 Handling Precautions for Product Mounting 】

<Recommendation>

Picking up point with nozzle : Lamp housing of the product ( area) (Shown below)

The pick up point is lamp housing only because the silicone resin used for the lens is soft. (If the nozzle makes contact with the lens, the products might be destroyed)

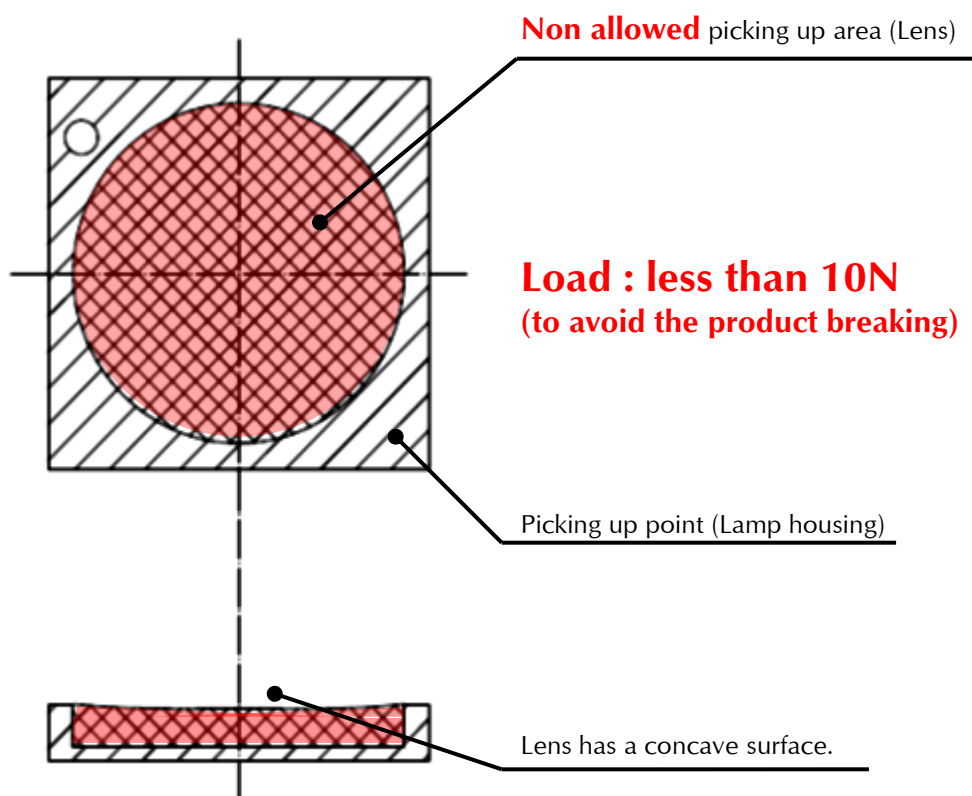

Please adjust the load, the pick up point, the nozzle diameter and etc. before mounting because the over load can cause the breakage of the lamp housing.

This product is baked (moisture removal) before packaging, and is shipped in moisture-proof packaging (as shown below) to minimize moisture absorption during transportation and storage. However, with regard to storing the products, Stanley recommends the use of dry-box under the following conditions is recommended. Moisture-proof bag as the packaging is made of anti-static material but packaging box is not.

【Recommended Storage Condition / Products Warranty Period】

| | |
|-------------|-----------|
| Temperature | +5~30°C |
| Humidity | Under 70% |

In the case of the package unopened , 6 months under 【 Recommended Storage Condition 】, Please avoid rapid transition from low temp. condition to high temp. condition and storage in corroding and dusty environment.

【Time elapsed after Package Opening】

If any LED remain unused, please put it back to moisture-proof bag, reseal the package and store it under the conditions described in the 【 Recommended Storage Condition 】,
When over 6 months passed after first opening of package, please do confirm the solder wettability of the terminals.

Baking (moisture removal) is not needed for this product.

Please do not bake LEDs with carrier tape.

【Moisture-proof Packaging Specification】

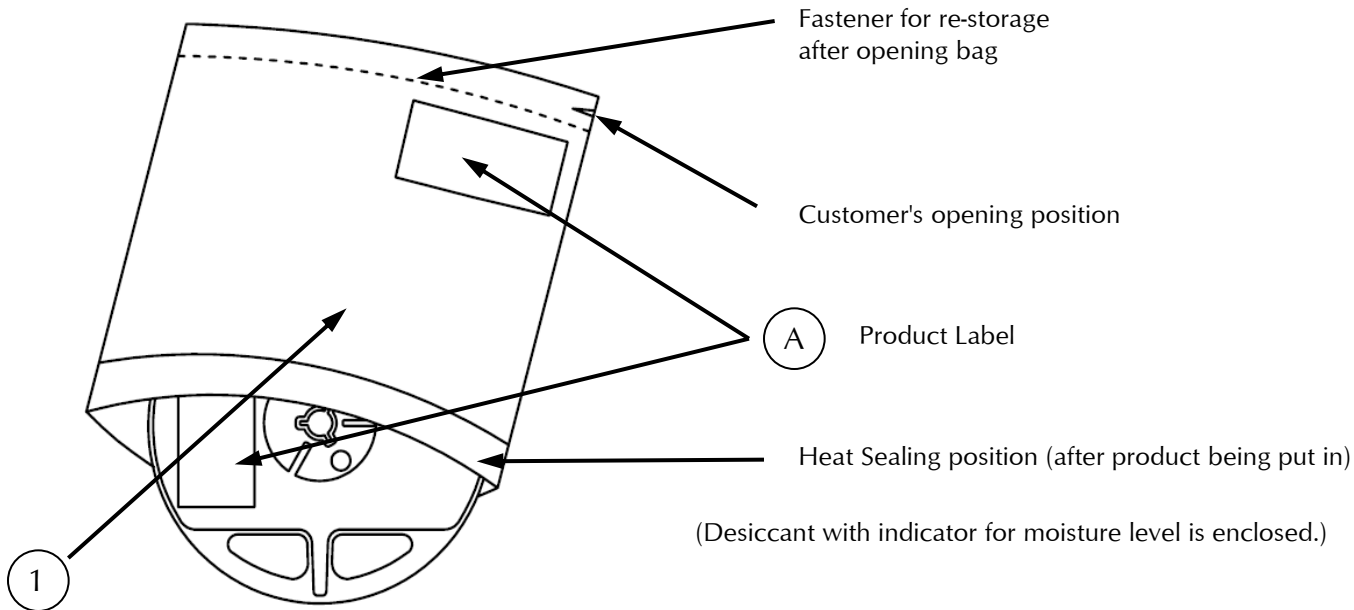

| SYM. | PART NAME | MATELRIAL | REMARKS |
|------|--|-----------|---------------------|
| ① | Moisture-proof bag with Aluminum layer | PET+Al+PE | with ESD protection |

Packaging Specifications

GSPW1651NSE-30Z-TR

【Packing box】

(RoHS•ELV Compliant)

| Box TYPE | Outline dimension L × W × H (mm) | Capacity of the box |
|----------|-------------------------------------|---------------------|
| Type A | 280 × 265 × 45 | 3 reels |
| Type B | 310 × 235 × 265 | 15 reels |
| Type C | 440 × 310 × 265 | 30 reels |

The above measure is all the reference value.

Shipping box is selected out of the above table by shipping quantity.

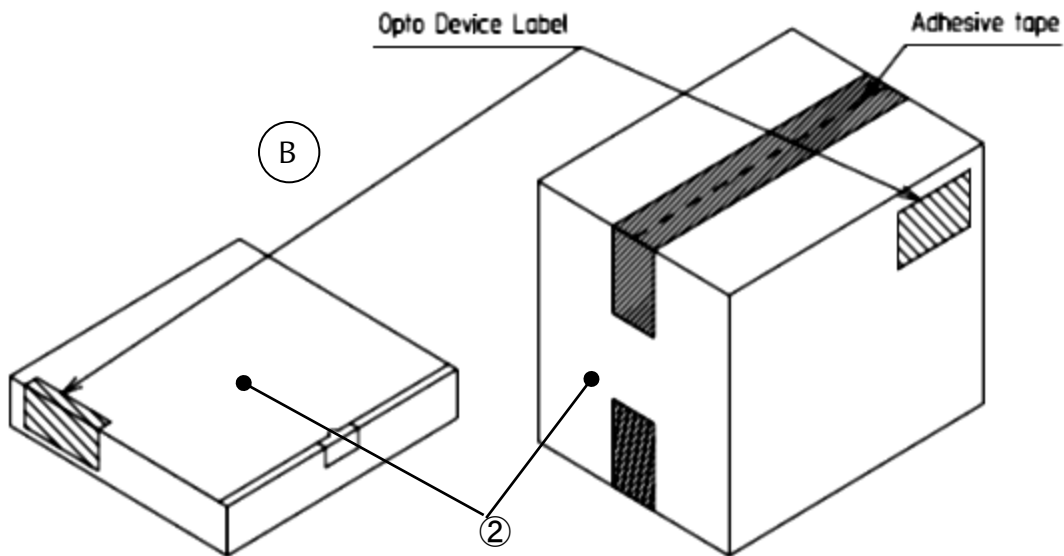

Type A

Material / box : Cardboard C5BF

Type B,C

Material / box : Cardboard K5AF

Partition : Cardboard K5AF

| SYM. | PART NAME | MATELRIAL | REMARKS |
|------|-------------|-------------------------|---------------------------|
| ② | Packing Box | Corrugated Cardboard | without ESD protection |

【Label Specification】

(acc.to JIS-X0503(Code-39))

A Product Label

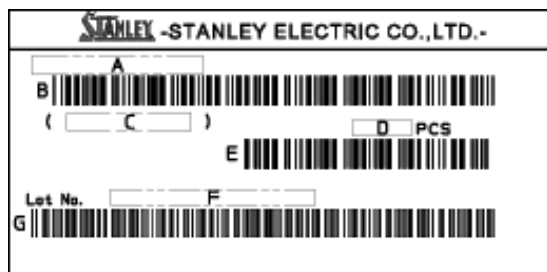

- A. Parts number
- B. Bar-code for parts number
- C. Parts code (In-house identification code for each parts number)
- D. Packed parts quantity
- E. Bar-Code for packed parts quantity
- F. Lot number & Rank
(refer to Lot Number Notational System for details)
- G. Bar-Code for Lot number & Rank

B Opto Device Label

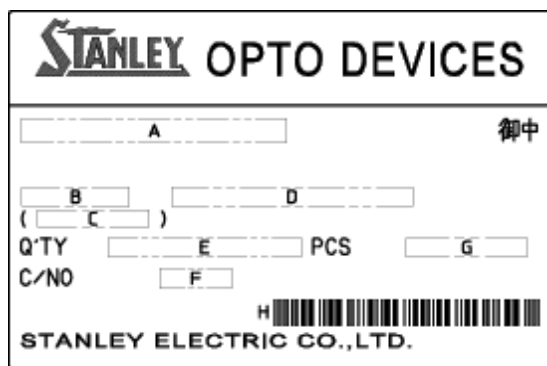

- A. Customer Name
- B. Parts Type
- C. Parts Code
- D. Parts Number
- E. Packed Parts Quantity
- F. Carton Number
- G. Shipping Date
- H. Bar-Code for In-house identification Number

<Remark> Bar-code font : acc.to Code-39(JIX0503)

Taping and Reel Specifications

GSPW1651NSE-30Z-TR

(acc.to JIS-C0806-03)

【Appearance】

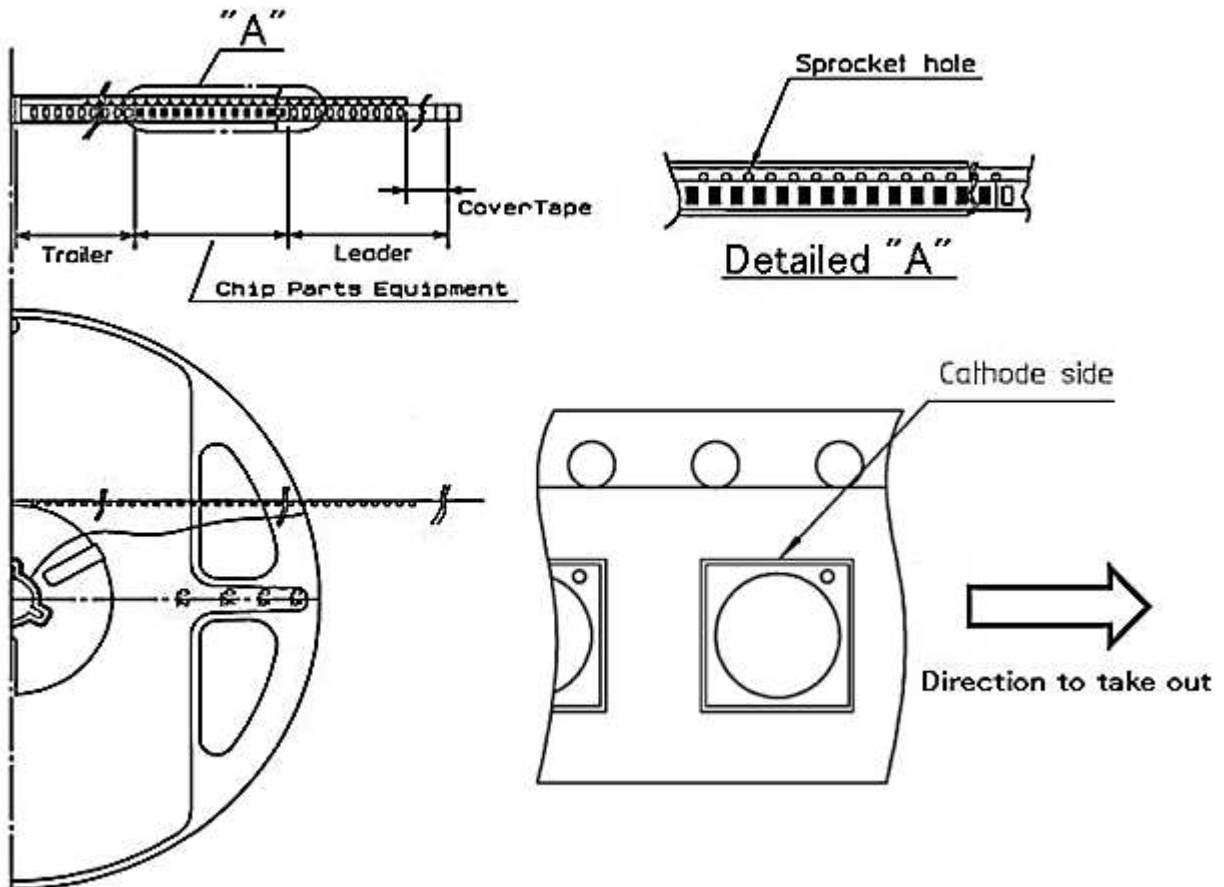

Note

"-TR" means Cathode Side of LEDs should be placed on the sprocket-hole side.

| Items | | Specifications | Remarks |
|--------------|--------------|--|--|
| Leader area | Cover-tape | Cover-tape shall be longer than 320mm without carrier-tape | The end of cover-tape shall be held with adhesive tape. |
| | Carrier-tape | Empty pocket shall be more than 13(100mm) pieces. | Please refer to the above figure for Taping & reel orientation . |
| Trailer area | | Empty pocket shall be more than 20(160mm) 15 pieces. | The end of taping shall be inserted into a slit of the hub. |

Taping and Reel Specifications

GSPW1651NSE-30Z-TR

(acc.to JIS-C0806-03)

【Qty. per Reel】

2,000parts/reel

Minimum Qty. per reel might be 500 parts when getting less than 2,000 parts. In such case, parts of 500-unit-qty. shall be packed in a reel and the qty. shall be identified on the label.

【Mechanical strength】

Cover-tape adhesive strength shall be 0.1~1.3N (An angle between carrier-tape and cover-tape shall be170 deg.). Both tapes shall be so sealed that the contained parts will not come out from the tape when it is bent at a radius of 15mm.

【Others】

Reversed-orientation, Up-side down placing, side placing and out of spec. parts mix shall not be held. Max qty. of empty pocket per reel shall be defined as follows.

Max, qty. of empty pocket per reel shall be defined as follows.

| Qty./Reel | Max.Qty. of empty pocket | Remarks |
|-----------|--------------------------|----------------|
| 500 | 1 | - |
| 1,000 | 1 | - |
| 1,500 | 1 | - |
| 2,000 | 2 | No continuance |

Lot Number Notational System

GSPW1651NSE-30Z-TR

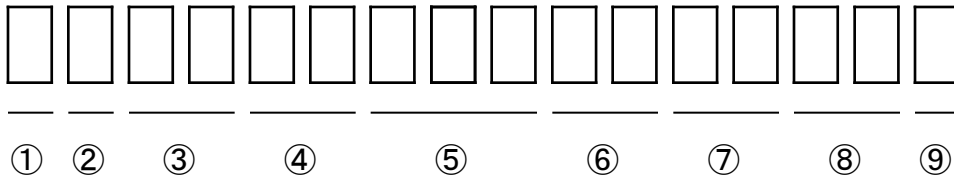

① - 1digit : Production Location (Mark identify alphabet)

② - 1digit : Production Year (Last digit of Production Year 2009→9,2010→0,2011→1,···)

③ - 2digits : Production Month (Jan. to Sep. should be 01,02,03,·····)

④ - 2digits : Production Date

⑤ - 3digits : Serial Number

⑥ - 2digits : Tape and Reel following Number

⑦ - 2digits : Luminous Intensity Rank.

(If luminous intensity rank is 1 digit, "-" shall be dashed on the place for the second digit.

If there is no identified intensity rank, "- ." is used to indicate.)

⑧ 2digits Chromaticity Rank

(If chromaticity rank is 1 digit, "-" shall be dashed on the place for the second digit.

If there is no identified intensity rank, "- ." is used to indicate.)

Chromaticity Rank

| Rank Code | Chromaticity Rank |
|-----------|-------------------|
| 2A | 30A |
| 2B | 30B |
| 2C | 30C |
| 2D | 30D |
| 2G | 30G |

⑨ - 1digit : VF Rank(If there is no identified VF rank, "- ." is used to indicate.)

This product is in compliance with RoHS•ELV.

Prohibition substance and its criteria value of RoHS•ELV are as follows.

- RoHS instruction Refer to following (1)~(6).
- ELV instruction Refer to following (1)~(4).

| | Substance Group Name | Criteria Value |
|-----|---------------------------|----------------|
| (1) | Lead and its compounds | 1,000ppm Max |
| (2) | Cadmium and its compounds | 100ppm Max |
| (3) | Mercury and its compounds | 1,000ppm Max |
| (4) | Hexavalent chromium | 1,000ppm Max |
| (5) | PBB | 1,000ppm Max |
| (6) | PBDE | 1,000ppm Max |

1. Reliability Testing Result

| Test Item | Standard | Test Condition | Duration | Failure |
|-------------------------------------|------------------------|---|-----------------------|---------|
| Room Temperature Operating Life | EIAJ ED-4701 /100(101) | Ta=25°C I _F =600mA | 1,000h | 0 / 20 |
| High Temperature Operating Life | EIAJ ED-4701 /100(101) | Ta=85°C I _F =600mA | 1,000h | 0 / 20 |
| Low Temperature Operating Life | EIAJ ED-4701 /100(101) | Ta= -40°C I _F =600mA | 1,000h | 0 / 20 |
| Wet High Temperature Operating Life | EIAJ ED-4701 /100(102) | Ta=60°C 90% I _F =600mA | 1,000h | 0 / 20 |
| High Temperature Storage Life | EIAJ ED-4701 /200(201) | Ta=100°C | 1,000h | 0 / 20 |
| Low Temperature Storage Life | EIAJ ED-4701 /200(202) | Ta= -30°C | 1,000h | 0 / 20 |
| Thermal Shock | EIAJ ED-4701 /100(105) | Ta= -30°C ~100°C (each 15min) | 1,000 cycles | 0 / 20 |
| Resistance to Reflow Soldering | EIAJ ED-4701 /300(301) | Moisture Soak : 30°C 70% 168h Preheating : 150~180°C 120sec MAX. Soldering : 260°C Peak | 2times | 0 / 20 |
| Electrostatic Discharge (ESD) ※1 | EIAJ ED-4701 /300(304) | C=100pF R2=1.5kΩ ±2,000V | Once of each polarity | 0 / 20 |

※1 Reference test

2. Failure Criteria

| Item | Symbol | Conditions | Failure Criteria |
|---------------------|----------------|-----------------------|--|
| Luminous Intensity | I _V | I _F =100mA | Testing Min. Value < Standard Min. Value × 0.5 |
| Forward Voltage | V _F | I _F =100mA | Testing Max. Value ≥ Standard Max. Value × 1.2 |
| Cosmetic appearance | - | - | Occurrence of notable decoloration, deformation and cracking |

Special Notice to Customers Using the Products and Technical Information Shown in This Data Sheet

- 1) The technical information shown in the data sheets are limited to the typical characteristics and circuit examples of the referenced products. It does not constitute the warranting of industrial property nor the granting of any license.
- 2) For the purpose of product improvement, the specifications, characteristics and technical data described in the data sheets are subject to change without prior notice. Therefore it is recommended that the most updated specifications be used in your design.
- 3) When using the products described in the data sheets, please adhere to the maximum ratings for operating voltage, heat dissipation characteristics, and other precautions for use. We are not responsible for any damage which may occur if these specifications are exceeded.
- 4) The products that have been described to this catalog are manufactured so that they will be used for the electrical instrument of the benchmark (OA equipment, telecommunications equipment, AV machine, home appliance and measuring instrument).
The application of aircrafts, space borne application, transportation equipment, medical equipment and nuclear power control equipment, etc. needs a high reliability and safety, and the breakdown and the wrong operation might influence the life or the human body. Please consult us beforehand if you plan to use our product for the usages of aircrafts, space borne application, transportation equipment, medical equipment and nuclear power control equipment, etc. except OA equipment, telecommunications equipment, AV machine, home appliance and measuring instrument.
- 5) In order to export the products or technologies described in this data sheet which are under the "Foreign Exchange and Foreign Trade Control Law," it is necessary to first obtain an export permit from the Japanese government.
- 6) No part of this data sheet may be reprinted or reproduced without prior written permission from Stanley Electric Co., Ltd.
- 7) The most updated edition of this data sheet can be obtained from the address below:
<http://www.stanley-components.com/en/>