



Chipsmall Limited consists of a professional team with an average of over 10 year of expertise in the distribution of electronic components. Based in Hongkong, we have already established firm and mutual-benefit business relationships with customers from,Europe,America and south Asia,supplying obsolete and hard-to-find components to meet their specific needs.

With the principle of “Quality Parts,Customers Priority,Honest Operation,and Considerate Service”,our business mainly focus on the distribution of electronic components. Line cards we deal with include Microchip,ALPS,ROHM,Xilinx,Pulse,ON,Everlight and Freescale. Main products comprise IC,Modules,Potentiometer,IC Socket,Relay,Connector.Our parts cover such applications as commercial,industrial, and automotives areas.

We are looking forward to setting up business relationship with you and hope to provide you with the best service and solution. Let us make a better world for our industry!



## Contact us

Tel: +86-755-8981 8866 Fax: +86-755-8427 6832

Email & Skype: info@chipsmall.com Web: www.chipsmall.com

Address: A1208, Overseas Decoration Building, #122 Zhenhua RD., Futian, Shenzhen, China



COUNT	DESCRIPTION OF REVISIONS	BY	CHKD	DATE	COUNT	DESCRIPTION OF REVISIONS	BY	CHKD	DATE
4	RE-T-00607	T.I	M.C	'01.11.28					

A

B

C

D

E

F

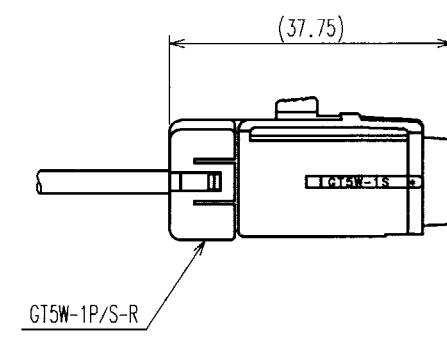
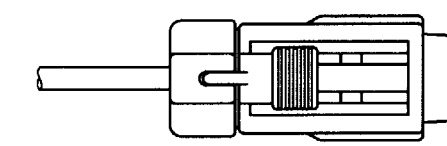
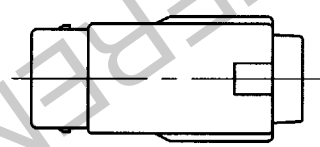
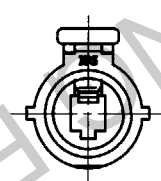
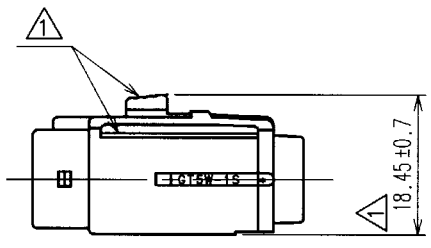
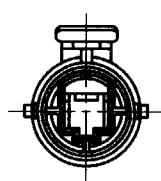
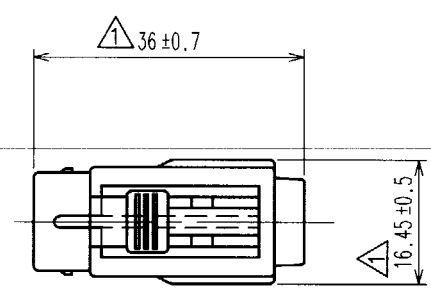

CONNECTOR ASSEMBLED WITH A RETAINER

HRS DRAWING FOR REFERENCE

NOTE1. A SUITABLE RETAINER FOR CABLE SIZE SHALL BE ASSEMBLED BEFORE USE.

TO

NO.	MATERIAL	FINISH, REMARKS	NO.	MATERIAL	FINISH, REMARKS
1	PBT-M	LIGHT GRAY			
CODE NO. (OLD)	CL559-0213-6		DRAWN	DESIGNED	CHECKED
			T.EBIHARA	N.NAKATA	K.SATO
			'97. 6. 26	'97. 6. 30	'97. 7. 1
					M.YAMAMOTO
					'97. 7. 1
					..
SCALE	DRAWING NO. EDC3-165087		PART NO. GT5W-1S-HU		
1 : 1					
UNITS	HRS HIROSE ELECTRIC CO., LTD		CODE NO. CL755-0027-2		1/1
mm					