



Chipsmall Limited consists of a professional team with an average of over 10 year of expertise in the distribution of electronic components. Based in Hongkong, we have already established firm and mutual-benefit business relationships with customers from,Europe,America and south Asia,supplying obsolete and hard-to-find components to meet their specific needs.

With the principle of “Quality Parts,Customers Priority,Honest Operation,and Considerate Service”,our business mainly focus on the distribution of electronic components. Line cards we deal with include Microchip,ALPS,ROHM,Xilinx,Pulse,ON,Everlight and Freescale. Main products comprise IC,Modules,Potentiometer,IC Socket,Relay,Connector.Our parts cover such applications as commercial,industrial, and automotives areas.

We are looking forward to setting up business relationship with you and hope to provide you with the best service and solution. Let us make a better world for our industry!



Contact us

Tel: +86-755-8981 8866 Fax: +86-755-8427 6832

Email & Skype: info@chipsmall.com Web: www.chipsmall.com

Address: A1208, Overseas Decoration Building, #122 Zhenhua RD., Futian, Shenzhen, China



GlobTek, Inc. www.globtek.com 186 Veterans Drive, Northvale, NJ 07647 Tel. (201) 784-1000 Fax (201) 784-0111	Drawing Title: GTM91110P24024-CA-S, ITE / Medical Power Supply, Efficiency Level: N/A, Case Color/Style: PANTONE BLUE 072 UP or similar, Enclosed-Metal, Regulated Switchmode AC-DC Power Supply AC Adaptor, Input Rating: 100-240V~, 50-60 Hz, Molex Header (or equal) , Output Rating: 200W, 24V@8.33A, Output Configuration: N/A mm, N/A/6 Cond, , MOLEX 6-PIN FRICTION LOCK HEADER P/N 26-60-4060 MATES WITH PN: 09-50-3061, Ferrite: None, N/A, GT Cord # C1196, Pin Out: Pins 1,2,3: V+, Pins 4,5,6: Common, Blades/Input Cord: Not Applicable, Approvals: GOST-R VCCI FCC Ukraine China RoHS RoHS 2 WEEE SIQ SIQ CE CB Class I CB CE cETLus 60601-1 3rd	
	Model No. GTM91110P24024-CA-S	
	Part No./Ordering No. GTM91110P24024CAS(R)	Rev F

REVISION HISTORY

REV	DESCRIPTION	SUB	DATE	APPROVED
F	UPDATE TEMPLATE, Update electrical specifications to include Earth Leakage Current & Touch Current; Storage Temp -10C to 85C. Change AC Input CON 1 to 3 position Header, Molex p/n 26-60-4030 & revise pin assignment; show lug for Class I Earth Ground. Remove CQC PSE. Update CB to 3rd Operating Instructions. Update 60601-1 to cETLus 3rd. Update Instruction Sheet # 8. DC input end user instructions.	jsund	09/29/2014	QA
E	UPDATE MODEL NUMBER TO GTM91110P24024-CA-S	jsund	02/17/2014	QA
D	UPDATE LABEL 1 DIMENSIONS	jsund	11/05/2013	QA
C	UPDATE LABELS, UPDATE AVAILABLE WATTAGE WITH PERFORATED ENCLOSURE	jsund	09/18/2013	QA
B	LABEL: REMOVE 'RU' SYMBOL, OP CURRENT=4.0A, ADD UKRAINE, PSE SIQ FILE #; UPDATE PACKAGING	jsund	07/16/2013	QA
A	INITIAL RELEASE	jsund	06/28/2013	QA

In Addition to GlobTek Inc.'s renewed ISO9001:2008 - Quality Management System Certification, GlobTek Inc. is now certified to:

ISO13485:2003 - Medical Devices Quality Management System Certification
ISO14001:2004 - Environmental Management System Certification

ISO Certificates are available online at <http://www.globtek.com/iso-certificates/>

Customer Approval of Specification:

Please approve, sign and send back to GlobTek so we can complete order processing.

A delay in receipt of this form will delay delivery schedule.

Company Name:

Customer P/N:

Quote Number:

Date:

Authorized Representative Name:

Authorized Representative Signature:

The acceptance of this specification and use of the product described in this document indicates the acceptance and binding of the customer to Globtek terms and conditions, which supersede all other agreements, terms, and conditions (<http://en.globtek.com/terms-and-conditions/>).

Footnote:

GlobTek Inc. will not be liable for the safety and performance of these power supplies if unauthorized access and repair occurs. End user should consult applicable UL, CSA or EN standards for proper installation instruction.

Limitation of Use:

GlobTek product are not authorized for use as mission critical components in life support hazardous environment, nuclear or aircraft applications without prior written approval from the CEO of GlobTek Inc.

Contents of this document are subject to change without prior notice.

GTM91110P24024-CA-S, 200W, 24V@8.33A, Enclosed-Metal, Regulated Switchmode AC-DC Power Supply AC Adaptor

PROPRIETARY INFORMATION

PROPRIETARY OF GLOBTEK, INC. ANY REPRODUCTION, DISCLOSURE OR USE OF THIS DRAWING, IN WHOLE OR IN PART, IS HEREBY PROHIBITED EXCEPT AS SPECIFIED IN WRITING BY GLOBTEK, INC.

quest /08/20/2018 7:34:30 AM

GloTek, Inc. www.globtek.com 186 Veterans Drive, Northvale, NJ 07647 Tel. (201) 784-1000 Fax (201) 784-0111	Drawing Title: GTM91110P24024-CA-S, ITE / Medical Power Supply, Efficiency Level: N/A, Case Color/Style: PANTONE BLUE 072 UP or similar, Enclosed-Metal, Regulated Switchmode AC-DC Power Supply AC Adaptor, Input Rating: 100-240V~, 50-60 Hz, Molex Header (or equal) , Output Rating: 200W, 24V@8.33A, Output Configuration: N/A mm, N/A/6 Cond, , MOLEX 6-PIN FRICTION LOCK HEADER P/N 26-60-4060 MATES WITH PN: 09-50-3061, Ferrite: None, N/A, GT Cord # C1196, Pin Out: Pins 1,2,3: V+, Pins 4,5,6: Common, Blades/Input Cord: Not Applicable, Approvals: GOST-R VCCI FCC Ukraine China RoHS RoHS 2 WEEE SIQ SIQ CE CB Class I CB CE cETLus 60601-1 3rd	
	Model No. GTM91110P24024-CA-S	
	Part No./Ordering No. GTM91110P24024CAS(R)	Rev F

POWER SUPPLY INFORMATION

TYPE: Enclosed-Metal
TECHNOLOGY: Regulated Switchmode AC-DC Power Supply AC Adaptor
CASE COLOR: PANTONE BLUE 072 UP or similar
NAMEPLATE RATED INPUT: 100-240V~, 50-60 Hz, 4.0A
INPUT CONFIG: Molex Header (or equal)
WATTS: 200.0
VOLTS OUT: 24
CURRENT OUT (Amps): 8.33
BLADE/CORD INCLUDED: N/A:
BLADE/CORD INSTALLED: N/A:
GROUNDING CONFIGURATION
EFFICIENCY LEVEL: N/A
OUTPUT CONFIGURATION: N/A mm, N/A/6 Cond, , MOLEX 6-PIN FRICTION LOCK HEADER P/N 26-60-4060 MATES WITH PN: 09-50-3061,
CONNECTOR PIN OUT: Pins 1,2,3: V+, Pins 4,5,6: Common
LABEL SPECS: Standard GT,L-1186
PACK SPEC: Standard Perforated Frame, Individually

Notes/Modifications/Customizations (notes in this section supersede the values shown in the standard spec):

DIMENSIONS ARE IN MM UNLESS SPECIFIED OTHERWISE.

GlobTek, Inc. www.globtek.com 186 Veterans Drive, Northvale, NJ 07647 Tel. (201) 784-1000 Fax (201) 784-0111	Drawing Title: GTM91110P24024-CA-S, ITE / Medical Power Supply, Efficiency Level: N/A, Case Color/Style: PANTONE BLUE 072 UP or similar, Enclosed-Metal, Regulated Switchmode AC-DC Power Supply AC Adaptor, Input Rating: 100-240V~, 50-60 Hz, Molex Header (or equal) , Output Rating: 200W, 24V@8.33A, Output Configuration: N/A mm, N/A/6 Cond. , MOLEX 6-PIN FRICTION LOCK HEADER P/N 26-60-4060 MATES WITH PN: 09-50-3061, Ferrite: None, N/A, GT Cord # C1196, Pin Out: Pins 1,2,3: V+, Pins 4,5,6: Common, Blades/Input Cord: Not Applicable, Approvals: GOST-R VCCI FCC Ukraine China RoHS RoHS 2 WEEE SIQ SIQ CE CB Class I CB CE cETLus 60601-1 3rd	
	Model No. GTM91110P24024-CA-S	
	Part No./Ordering No. GTM91110P24024CAS(R)	Rev F

ELECTRICAL SPECIFICATIONS

A) ELECTRICAL SPECIFICATIONS:

01. Input Voltage: Specified 90-264 Vac, Nameplate rated 100-240 Vac
02. Input Frequency: Specified 47-63 Hz, Nameplate rated 50/60 Hz
03. Inrush current: Cold start @ 25°C, 40A @ 115Vac, 80A @ 230Vac
04. Efficiency: 85% to 90% typical at full load, 120-240Vac input
05. Power factor: 0.98 typical at full load, 230Vac input
06. Turn on delay: 5 Seconds maximum, (3 seconds max option)
07. Load regulation: $\pm 1\%$ Measured at the connector side
08. Line regulation: $\pm 0.2\%$ Measured at the connector side
09. Output Ripple protection (Peak to Peak): $\pm 1\%$ maximum of nominal output voltage measured at 20 MHz bandwidth with 0.1 μ f ceramic capacitor in parallel with a low impedance 47 μ f electrolytic capacitor located 200mm from the end of the output connector
10. Turn on/off overshoot: 5% Maximum, 1mS recovery time
11. Hold up time: 8 mS @ 300W load, 10mS@200W load, 16mS@150W load at 115Vac input
12. Transient response: 2% Maximum deviation, returns to initial condition in 3 ms max for 25% load step, from 10% to 100% of rated load
13. Remote sense (optional): compensates for up to 0.5V voltage drop in output wiring.
Power supply will operate correctly, with or without remote sense pins hooked up.
14. Auxillary Output: For forced air fan 12V @ 250mA, if convection cooled 12V @ 150mA. Other output voltages and current ratings from 5V to 24V available, contact factory for availability.
15. Indicator: Green LED for output presence

B) PROTECTION

01. Input Protection: Input line fusing and 300Vac MOV
02. Short circuit: Protected. Unit will autorecover upon removal of short
03. Overload protection: Autorecover upon removal of overload
 - 150W, 175% - 210% of nominal power rating
 - 200W, 130% - 160% of nominal power rating
 - 240W, 110% - 130% of nominal power rating
 - 300W, 110% - 130% of nominal power rating
04. Over voltage: Protected at 110- 140% of nominal output voltage, latched type. AC cycling required to restore output. Autorecovery type OVP is an option, contact factory for availability.
05. Fan output protection: 3 Pin Linear Regulator, short circuit proof

C) SAFETY

01. Dielectric Withstand Voltage: 4000Vac or 5656Vdc from input to output,
On Class I models, 2500Vac or 3535Vdc from input to earth
02. Earth Leakage Current:
Class I Input Models: Does not exceed 500uA
Class II Input Models: Does not apply
03. Touch Current: Does not exceed 100uA, output terminations to earth
04. Output terminations rated as SELV, and Means of Operator Protection

D) OTHER:

01. MTBF: 200,000 Hours @ 25°C ambient temperature
02. Operating Temperature Range:
-10°C to 50°C @ 100% output power rating
-10°C to 70°C @ 50% output power derating
03. Cooling:
Open Frame 150W Series: Convection
Open Frame 240W and 300W Series: 20 CFM Forced Air Cooling
Perforated Plastic Housing 200W Series: 20 CFM Forced Air Cooling,
with convection cooling 50% derated (100W) output capability.
04. Relative Humidity: operating 0% to 90% Non-condensing
05. Storage Temperature: -30°C to 85°C

PROPRIETARY INFORMATION

PROPRIETARY OF GLOBTEK, INC. ANY REPRODUCTION, DISCLOSURE OR USE OF THIS DRAWING, IN WHOLE OR IN PART, IS HEREBY PROHIBITED EXCEPT AS SPECIFIED IN WRITING BY GLOBTEK, INC.

quest /08/20/2018 7:34:30 AM

GloTek, Inc. www.globtek.com 186 Veterans Drive, Northvale, NJ 07647 Tel. (201) 784-1000 Fax (201) 784-0111	Drawing Title: GTM91110P24024-CA-S, ITE / Medical Power Supply, Efficiency Level: N/A, Case Color/Style: PANTONE BLUE 072 UP or similar, Enclosed-Metal, Regulated Switchmode AC-DC Power Supply AC Adaptor, Input Rating: 100-240V~, 50-60 Hz, Molex Header (or equal) , Output Rating: 200W, 24V@8.33A, Output Configuration: N/A mm, N/A/6 Cond. , MOLEX 6-PIN FRICTION LOCK HEADER P/N 26-60-4060 MATES WITH PN: 09-50-3061, Ferrite: None, N/A, GT Cord # C1196, Pin Out: Pins 1,2,3: V+, Pins 4,5,6: Common, Blades/Input Cord: Not Applicable, Approvals: GOST-R VCCI FCC Ukraine China RoHS RoHS 2 WEEE SIQ SIQ CE CB Class I CB CE cETLus 60601-1 3rd	
	Model No. GTM91110P24024-CA-S	
	Part No./Ordering No. GTM91110P24024CAS(R)	Rev F

- 06. Altitude: up to 2000 meter
- 07. Random vibration/transient drop: MIL-STD 810E

E) MECHANICAL FORMAT:

150W, 240W and 300W Open Frame version

Size: 127*76.2*43 mm

Weight: 470 grams

200W Perforated Plastic Enclosure version

Size: 140*87.6*51.9 mm

Weight: 620 grams

GlobTek, Inc.
 www.globtek.com
 186 Veterans Drive,
 Northvale, NJ 07647
 Tel. (201) 784-1000
 Fax (201) 784-0111

Drawing Title: GTM91110P24024-CA-S, ITE / Medical Power Supply, Efficiency Level: N/A, Case Color/Style: PANTONE BLUE 072 UP or similar, Enclosed-Metal, Regulated Switchmode AC-DC Power Supply AC Adaptor, Input Rating: 100-240V~, 50-60 Hz, Molex Header (or equal) , Output Rating: 200W, 24V@8.33A, Output Configuration: N/A mm, N/A/6 Cond, , MOLEX 6-PIN FRICTION LOCK HEADER P/N 26-60-4060 MATES WITH PN: 09-50-3061, Ferrite: None, N/A, GT Cord # C1196, Pin Out: Pins 1,2,3: V+, Pins 4,5,6: Common, Blades/Input Cord: Not Applicable, Approvals: GOST-R VCCI FCC Ukraine China RoHS RoHS 2 WEEE SIQ SIQ CE CB Class I CB CE cETLus 60601-1 3rd

Model No. GTM91110P24024-CA-S

Part No./Ordering No. GTM91110P24024CAS(R)

Rev F

AIRFLOW DIRECTION FOR 200W VERSION

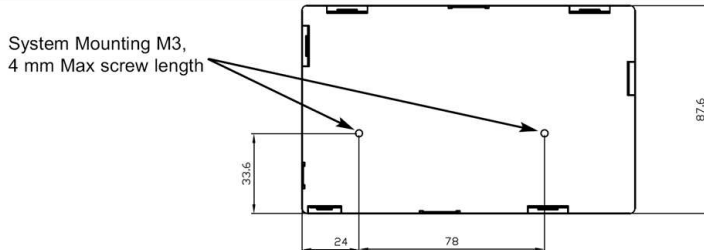
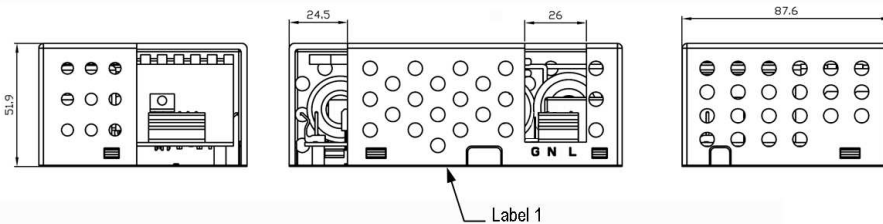
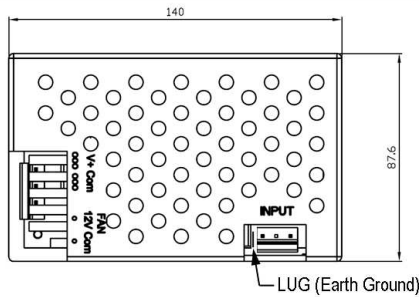
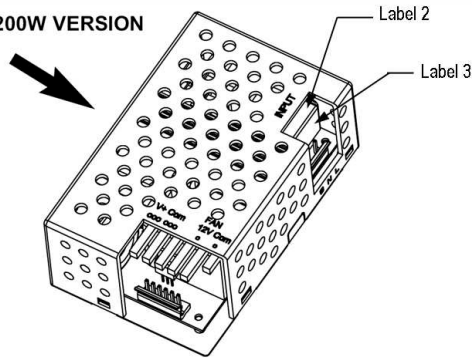

GlobTek, Inc. www.globtek.com 186 Veterans Drive, Northvale, NJ 07647 Tel. (201) 784-1000 Fax (201) 784-0111	Drawing Title: GTM91110P24024-CA-S, ITE / Medical Power Supply, Efficiency Level: N/A, Case Color/Style: PANTONE BLUE 072 UP or similar, Enclosed-Metal, Regulated Switchmode AC-DC Power Supply AC Adaptor, Input Rating: 100-240V~, 50-60 Hz, Molex Header (or equal) , Output Rating: 200W, 24V@8.33A, Output Configuration: N/A mm, N/A/6 Cond. , MOLEX 6-PIN FRICTION LOCK HEADER P/N 26-60-4060 MATES WITH PN: 09-50-3061, Ferrite: None, N/A, GT Cord # C1196, Pin Out: Pins 1,2,3: V+, Pins 4,5,6: Common, Blades/Input Cord: Not Applicable, Approvals: GOST-R VCCI FCC Ukraine China RoHS RoHS 2 WEEE SIQ SIQ CE CB Class I CB CE cETLus 60601-1 3rd	
	Model No. GTM91110P24024-CA-S	
	Part No./Ordering No. GTM91110P24024CAS(R)	Rev F

Label 1
 Position Label 1 on outside bottom plate

Label 2
 Material: White art paper with Black nomenclature and is attached on top of CX1

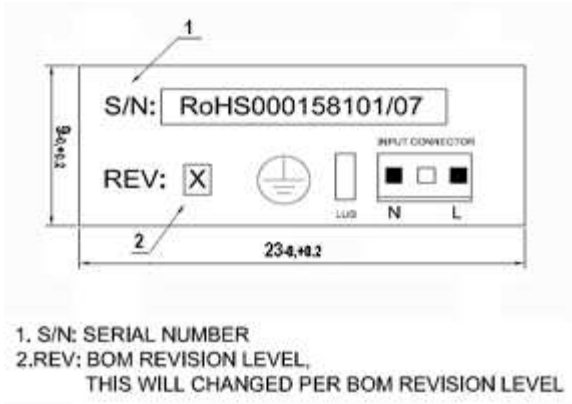

Label 3
 Material: White art paper with Black nomenclature and is attached on side of CX1

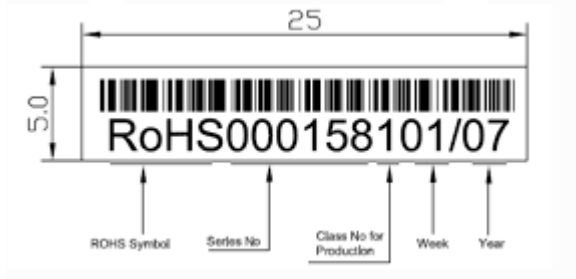

DERATING CURVE

GlobTek, Inc.
 www.globtek.com
 186 Veterans Drive,
 Northvale, NJ 07647
 Tel. (201) 784-1000
 Fax (201) 784-0111

Drawing Title: GTM91110P24024-CA-S, ITE / Medical Power Supply, Efficiency Level: N/A, Case Color/Style: PANTONE BLUE 072 UP or similar, Enclosed-Metal, Regulated Switchmode AC-DC Power Supply AC Adaptor, Input Rating: 100-240V~, 50-60 Hz, Molex Header (or equal) , Output Rating: 200W, 24V@8.33A, Output Configuration: N/A mm, N/A/6 Cond, , MOLEX 6-PIN FRICTION LOCK HEADER P/N 26-60-4060 MATES WITH PN: 09-50-3061, Ferrite: None, N/A, GT Cord # C1196, Pin Out: Pins 1,2,3: V+, Pins 4,5,6: Common, Blades/Input Cord: Not Applicable, Approvals: GOST-R VCCI FCC Ukraine China RoHS RoHS 2 WEEE SIQ SIQ CE CB Class I CB CE cETLus 60601-1 3rd

Model No. GTM91110P24024-CA-S

Part No./Ordering No. GTM91110P24024CAS(R)

Rev F

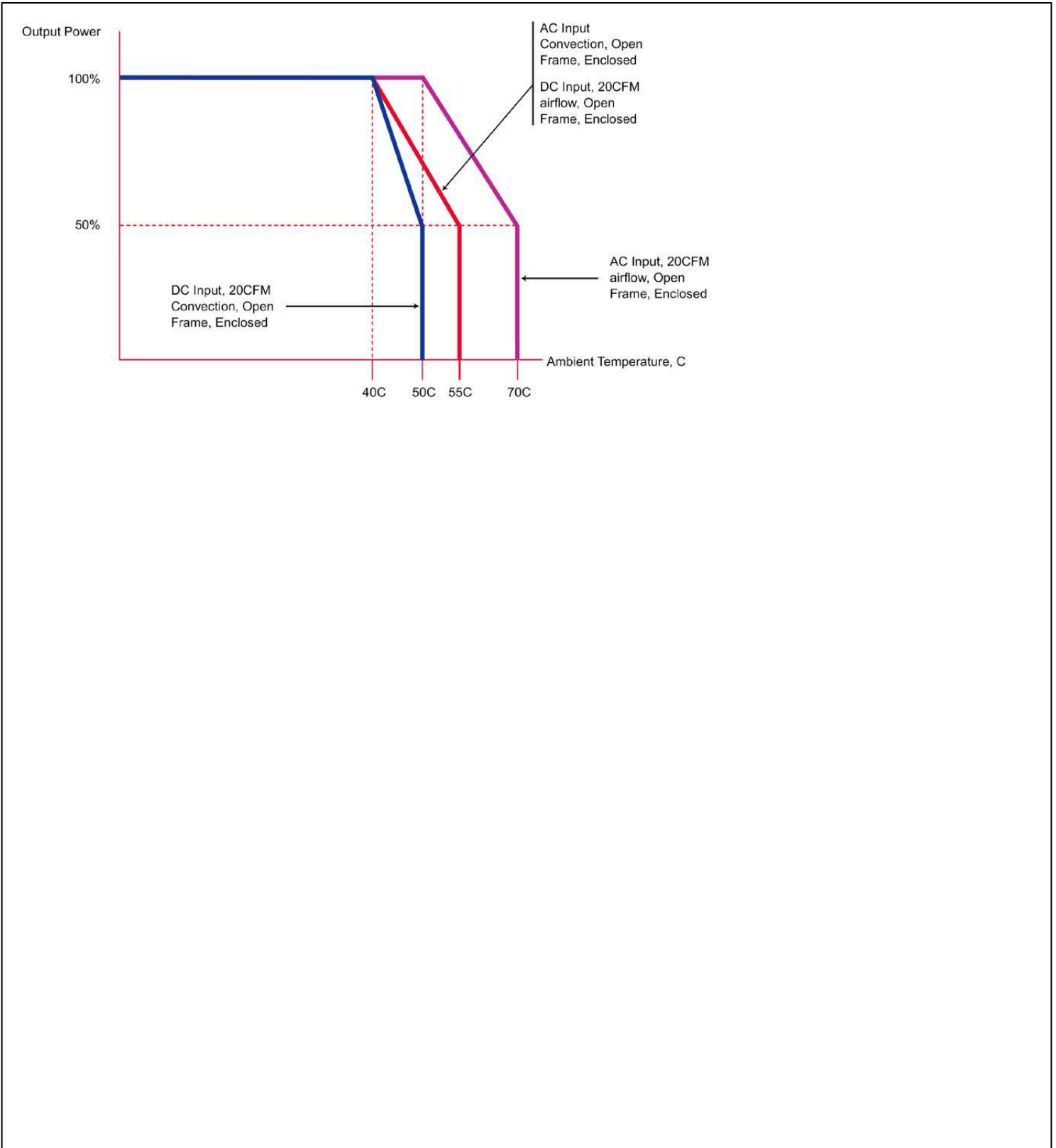

GlobTek, Inc.
 www.globtek.com
 186 Veterans Drive,
 Northvale, NJ 07647
 Tel. (201) 784-1000
 Fax (201) 784-0111

Drawing Title: GTM91110P24024-CA-S, ITE / Medical Power Supply, Efficiency Level: N/A, Case Color/Style: PANTONE BLUE 072 UP or similar, Enclosed-Metal, Regulated Switchmode AC-DC Power Supply AC Adaptor, Input Rating: 100-240V~, 50-60 Hz, Molex Header (or equal) , Output Rating: 200W, 24V@8.33A, Output Configuration: N/A mm, N/A/6 Cond, , MOLEX 6-PIN FRICTION LOCK HEADER P/N 26-60-4060 MATES WITH PN: 09-50-3061, Ferrite: None, N/A, GT Cord # C1196, Pin Out: Pins 1,2,3: V+, Pins 4,5,6: Common, Blades/Input Cord: Not Applicable, Approvals: GOST-R VCCI FCC Ukraine China RoHS RoHS 2 WEEE SIQ SIQ CE CB Class I CB CE cETLus 60601-1 3rd

Model No. GTM91110P24024-CA-S

Part No./Ordering No. GTM91110P24024CAS(R)

Rev F

INPUT CONFIGURATION

Blades/Cord Included: N/A:

Blades/Cord Installed: N/A:

Molex 26-60-4030 3 Position Header Pin 1: Line, Pin 2: Removed, PIN 3: Neutral

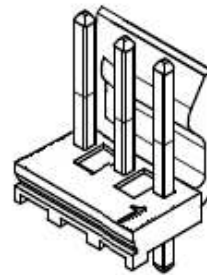
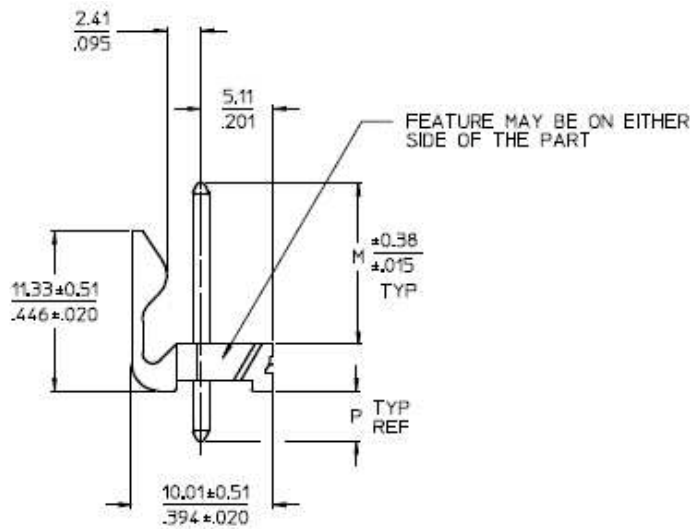

GlobTek, Inc. www.globtek.com 186 Veterans Drive, Northvale, NJ 07647 Tel. (201) 784-1000 Fax (201) 784-0111	Drawing Title: GTM91110P24024-CA-S, ITE / Medical Power Supply, Efficiency Level: N/A, Case Color/Style: PANTONE BLUE 072 UP or similar, Enclosed-Metal, Regulated Switchmode AC-DC Power Supply AC Adaptor, Input Rating: 100-240V~, 50-60 Hz, Molex Header (or equal) , Output Rating: 200W, 24V@8.33A, Output Configuration: N/A mm, N/A/6 Cond, , MOLEX 6-PIN FRICTION LOCK HEADER P/N 26-60-4060 MATES WITH PN: 09-50-3061, Ferrite: None, N/A, GT Cord # C1196, Pin Out: Pins 1,2,3: V+, Pins 4,5,6: Common, Blades/Input Cord: Not Applicable, Approvals: GOST-R VCCI FCC Ukraine China RoHS RoHS 2 WEEE SIQ SIQ CE CB Class I CB CE cETLus 60601-1 3rd	
	Model No. GTM91110P24024-CA-S	
	Part No./Ordering No. GTM91110P24024CAS(R)	Rev F

OUTPUT CORD AND CONNECTOR: MOLF/C1196

ACTUAL CONNECTORS, OVERMOLDS, FERRITES MAY VARY SLIGHTLY FROM THE PICTURE BELOW

CABLE TYPE

CABLE LENGTH (mm) N/A

CABLE TOLERANCE (mm) N/A

WIRE GAUGE (AWG) N/A

CONDUCTORS 6

HANK DIMENSION (mm) N/A

CABLE / CONNECTOR OVERMOLD COLOR N/A

FERRITE TYPE / DIMENSION None

FERRITE # OF TURNS ([Definition](#)) N/A

FERRITE DIMENSION FROM STRAIN RELIEF N/A

FERRITE DIMENSION FROM PLUG N/A

PLUG TYPE MOLEX 6-PIN FRICTION LOCK HEADER P/N 26-60-4060 MATES WITH PN: 09-50-3061

OVER MOLD ORIENTATION

CONNECTOR PIN OUT: Pins 1,2,3: V+, Pins 4,5,6: Common

ADDITIONAL REQUIREMENTS

Drawing: http://www.molex.com/pdm_docs/sd/022280040_sd.pdf

Datasheet: http://www.molex.com/molex/products/datasheet.jsp?part=active/0022280040_PCB_HEADERS.xml

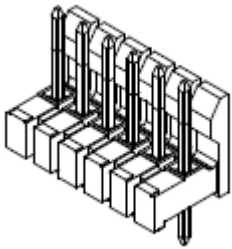

Mates With Part(s):

[KK® Crimp Housing 2695, 6471, 7880](#), [KK® PC Board Connector 4455](#)

ADDITIONAL OUTPUT PLUG OPTIONS ARE AVAILABLE AT <http://www.globtek.com/connectors/>

STANDARD PLUGS AND CONNECTORS CAN BE SEEN ONLINE AT <http://www.globtek.com/connectors/>

GlobTek, Inc. www.globtek.com 186 Veterans Drive, Northvale, NJ 07647 Tel. (201) 784-1000 Fax (201) 784-0111	Drawing Title: GTM91110P24024-CA-S, ITE / Medical Power Supply, Efficiency Level: N/A, Case Color/Style: PANTONE BLUE 072 UP or similar, Enclosed-Metal, Regulated Switchmode AC-DC Power Supply AC Adaptor, Input Rating: 100-240V~, 50-60 Hz, Molex Header (or equal) , Output Rating: 200W, 24V@8.33A, Output Configuration: N/A mm, N/A/6 Cond. , MOLEX 6-PIN FRICTION LOCK HEADER P/N 26-60-4060 MATES WITH PN: 09-50-3061, Ferrite: None, N/A, GT Cord # C1196, Pin Out: Pins 1,2,3: V+, Pins 4,5,6: Common, Blades/Input Cord: Not Applicable, Approvals: GOST-R VCCI FCC Ukraine China RoHS RoHS 2 WEEE SIQ SIQ CE CB Class I CB CE cETLus 60601-1 3rd	
	Model No. GTM91110P24024-CA-S	
	Part No./Ordering No. GTM91110P24024CAS(R)	Rev F

LABEL:L-1186

LABEL P/N: Standard GT
 MATERIAL: Flat Thermal Transfer, Imprintable, Polyester Label and/or Pad Printed and/or Molded, and/or Laser Engraved in the case
 BACKGROUND COLOR: Black if housing is Black, White or Silver if housing is White or Gray.
 TEXT COLOR: White or Silver if label is Black Background for Black housing. Black if label is White or Silver background and Housing is White or Gray
 LABEL WIDTH (mm): 50.0
 LABEL HEIGHT (mm): 50.0

Below is the minimum information which will appear on the label. NOTE: in the logo area additional/actual positioning of symbols and text is subjected to change as per agency updates/requirements or additional model approvals become available. Regulatory certifications/label markings may be in logo area on the label or molded into the case housing outside the label area. Information will be shown via label and/or pad printed and/or molded and/or laser engraved in the case. * Date code markings at GlobTek option.

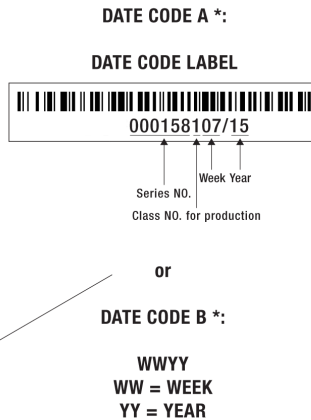
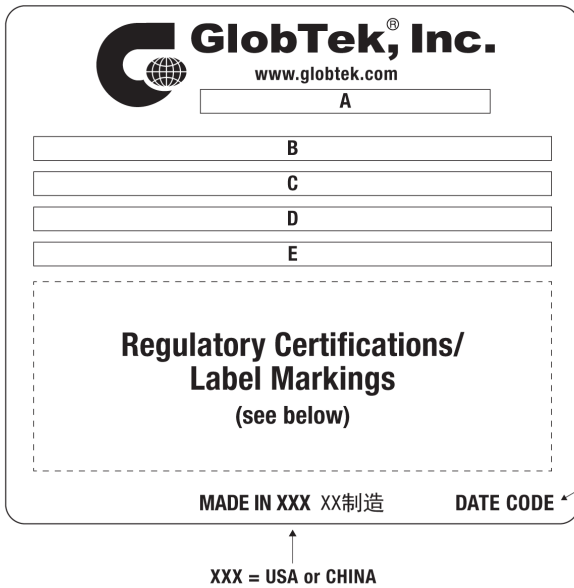

A=ITE / Medical Power Supply
 B=P/N: (料号) GTM91110P24024CAS(R)
 C=Model (型号) GTM91110P24024-CA-S
 D=Input (输入) 100-240V~, 50-60 Hz, 4.0A
 E=Output (输出)24 V 8.33 A ,200.0W

- AGENCY ONLINE DOCUMENTS <http://www.globtek.info/certs/GTM91110P/>
- CE EC-Declaration for Medical http://www.globtek.com/pdf/ec_declaration/a0Oa000000MgWUbeEAN
- CE EC-Declaration for Industrial/Commercial/ITE http://www.globtek.com/pdf/ec_declaration/a0Oa000000MgWUbeEAN
- RoHS/RoHS2 Declaration http://www.globtek.com/pdf/rohs_cert/01t30000002pMxZAAU
- REACH Declaration http://www.globtek.com/pdf/iso_certificates/REACH.pdf

GlobTek, Inc. www.globtek.com 186 Veterans Drive, Northvale, NJ 07647 Tel. (201) 784-1000 Fax (201) 784-0111	Drawing Title: GTM91110P24024-CA-S, ITE / Medical Power Supply, Efficiency Level: N/A, Case Color/Style: PANTONE BLUE 072 UP or similar, Enclosed-Metal, Regulated Switchmode AC-DC Power Supply AC Adaptor, Input Rating: 100-240V~, 50-60 Hz, Molex Header (or equal) , Output Rating: 200W, 24V@8.33A, Output Configuration: N/A mm, N/A/6 Cond. , MOLEX 6-PIN FRICTION LOCK HEADER P/N 26-60-4060 MATES WITH PN: 09-50-3061, Ferrite: None, N/A, GT Cord # C1196, Pin Out: Pins 1,2,3: V+, Pins 4,5,6: Common, Blades/Input Cord: Not Applicable, Approvals: GOST-R VCCI FCC Ukraine China RoHS RoHS 2 WEEE SIQ SIQ CE CB Class I CB CE cETLus 60601-1 3rd	
	Model No. GTM91110P24024-CA-S	
	Part No./Ordering No. GTM91110P24024CAS(R)	Rev F

Conflict Minerals Declaration

<http://www.globtek.com/pdf/conflict-minerals.pdf>

IPXY rating is based on 3rd party testing and customers should check suitability and test system level IPXY rating before ordering.

Regulatory Certifications/Label Markings

LATEST PRODUCT/MODEL CERTIFICATIONS: <http://en.globtek.com/datasheet/id/a0Oa000000MgWUub>

AGENCY ONLINE DOCUMENTS: <http://www.globtek.info/certs/GTM91110P/>

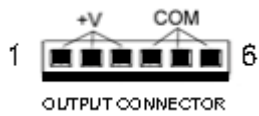

Pins 1,2,3: V+, Pins 4,5,6: Common

GlobTek, Inc. www.globtek.com 186 Veterans Drive, Northvale, NJ 07647 Tel. (201) 784-1000 Fax (201) 784-0111	Drawing Title: GTM91110P24024-CA-S, ITE / Medical Power Supply, Efficiency Level: N/A, Case Color/Style: PANTONE BLUE 072 UP or similar, Enclosed-Metal, Regulated Switchmode AC-DC Power Supply AC Adaptor, Input Rating: 100-240V~, 50-60 Hz, Molex Header (or equal) , Output Rating: 200W, 24V@8.33A, Output Configuration: N/A mm, N/A/6 Cond. , MOLEX 6-PIN FRICTION LOCK HEADER P/N 26-60-4060 MATES WITH PN: 09-50-3061, Ferrite: None, N/A, GT Cord # C1196, Pin Out: Pins 1,2,3: V+, Pins 4,5,6: Common, Blades/Input Cord: Not Applicable, Approvals: GOST-R VCCI FCC Ukraine China RoHS RoHS 2 WEEE SIQ SIQ CE CB Class I CB CE cETLus 60601-1 3rd	
	Model No. GTM91110P24024-CA-S	
	Part No./Ordering No. GTM91110P24024CAS(R)	Rev F

PACKAGING

Packing Spec P/N: Standard Perforated Frame, Individually

Box Qty: 36

Gift Box Size (mm): 160*67*90

Gift Box Color: White

Master Carton Size (mm): 430*340*304

Master GW (Kg): 14.0 kg

BLADES INCLUDED: N/A:

BLADE/CORD INSTALLED: N/A:

If specific packaging is required, this section must specify all requirements and note "no exceptions". If this section does not specify packaging, it is subject to change without notice at GlobTek's discretion

(Power Supply in picture for reference only)

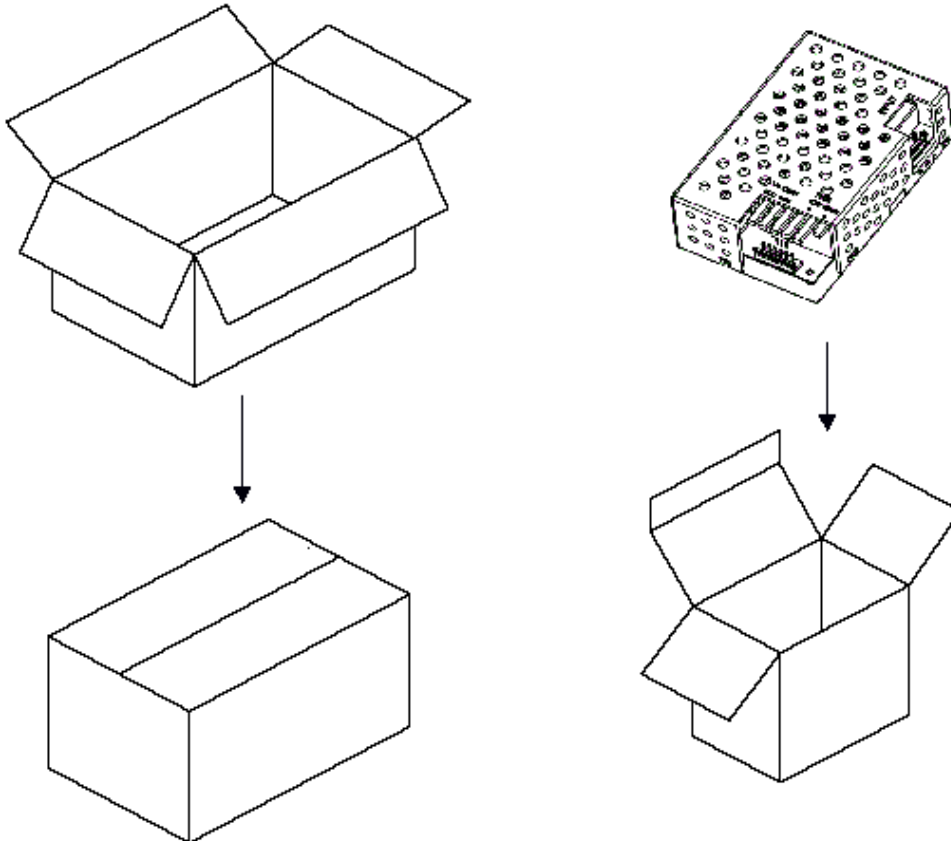

GlobTek, Inc. www.globtek.com 186 Veterans Drive, Northvale, NJ 07647 Tel. (201) 784-1000 Fax (201) 784-0111	Drawing Title: GTM91110P24024-CA-S, ITE / Medical Power Supply, Efficiency Level: N/A, Case Color/Style: PANTONE BLUE 072 UP or similar, Enclosed-Metal, Regulated Switchmode AC-DC Power Supply AC Adaptor, Input Rating: 100-240V~, 50-60 Hz, Molex Header (or equal) , Output Rating: 200W, 24V@8.33A, Output Configuration: N/A mm, N/A/6 Cond. , MOLEX 6-PIN FRICTION LOCK HEADER P/N 26-60-4060 MATES WITH PN: 09-50-3061, Ferrite: None, N/A, GT Cord # C1196, Pin Out: Pins 1,2,3: V+, Pins 4,5,6: Common, Blades/Input Cord: Not Applicable, Approvals: GOST-R VCCI FCC Ukraine China RoHS RoHS 2 WEEE SIQ SIQ CE CB Class I CB CE cETLus 60601-1 3rd	
	Model No. GTM91110P24024-CA-S	
	Part No./Ordering No. GTM91110P24024CAS(R)	Rev F

INSTRUCTION SHEET

Notes for GT(M)91110P240VV-ZA(W)-S

1. MEDICAL VERSION IS DESIGNED NOT TO BE USED IN SYSTEMS WITH DIRECT PATIENT CONTACT.
2. ALL MEASUREMENTS ARE MADE DIRECTLY AT THE TERMINALS OF THE SUPPLY.
3. OUTPUT RIPPLE AND SPIKE ARE MEASURED DIRECTLY AT THE OUTPUT TERMINALS OF THE POWER SUPPLY WITH 10 μ F TANTALUM AND 0.1 μ F CERAMIC CAPACITORS CONNECTED IN PARALLEL. PEAK-TO-PEAK METERING EQUIPMENT MUST HAVE A 20 MHz FREQUENCY RESPONSE WITH PROBES AND CABLES THAT MAINTAIN A FREQUENCY RESPONSE OF 20Hz TO 20MHz.
4. CONDUCTED AND RADIATED EMI WERE PERFORMED WITH RESISTIVE LOAD SET TO FULL LOAD. PSU AND RESISTIVE LOAD WERE MOUNTED TOGETHER IN AN ALUMINUM PLATE.
5. REMOTE SENSE WIRE SHOULD BE TWISTED TOGETHER WHEN USED.
6. ALL MEASUREMENTS ARE MADE AT 25°C AMBIENT TEMPERATURE AND ARE TYPICAL.
7. WHEN LONG INPUT AND/OR OUTPUT WIRE HARNESS IS USED, ADDITIONAL EMI FILTERING MAY BE NECESSARY. FERRITE CORE MAY BE ADDED TO THE WIRE HARNESS AS REQUIRED.
8. FOR DC INPUT, END USER MUST PROVIDE DC RATED FUSE ON THE V+ SIDE OF THE INPUT VOLTAGE. FUSE RATING IS 3A 350VDC.
- 9 IN COMPLIANCE TO IEC 60601-1 REQUIREMENT, A WARNING NOTICE IS ADDED. "WARNING: NO MODIFICATION TO THIS EQUIPMENT IS ALLOWED".
10. WARNING STATEMENT FOR CLASS I VERSION: "WARNING: TO AVOID RISK OF ELECTRIC SHOCK, THIS EQUIPMENT MUST ONLY BE CONNECTED TO A SUPPLY MAINS WITH PROTECTIVE EARTH".
11. GLOBTEK PRODUCTS ARE NOT AUTHORIZED TO BE USED AS MISSION CRITICAL COMPONENTS WITHOUT PRIOR WRITTEN APPROVAL FROM THE CEO OF GLOBTEK INC.
12. OTHER BRANDS OF SIMILAR SPECS MAY BE USED FOR INPUT AND OUTPUT CONNECTORS.
13. SPECIFICATIONS ARE SUBJECT TO CHANGE WITHOUT PRIOR NOTICE.