



Chipsmall Limited consists of a professional team with an average of over 10 year of expertise in the distribution of electronic components. Based in Hongkong, we have already established firm and mutual-benefit business relationships with customers from,Europe,America and south Asia,supplying obsolete and hard-to-find components to meet their specific needs.

With the principle of “Quality Parts,Customers Priority,Honest Operation,and Considerate Service”,our business mainly focus on the distribution of electronic components. Line cards we deal with include Microchip,ALPS,ROHM,Xilinx,Pulse,ON,Everlight and Freescale. Main products comprise IC,Modules,Potentiometer,IC Socket,Relay,Connector.Our parts cover such applications as commercial,industrial, and automotives areas.

We are looking forward to setting up business relationship with you and hope to provide you with the best service and solution. Let us make a better world for our industry!



Contact us



Tel: +86-755-8981 8866 Fax: +86-755-8427 6832

Email & Skype: info@chipsmall.com Web: www.chipsmall.com

Address: A1208, Overseas Decoration Building, #122 Zhenhua RD., Futian, Shenzhen, China

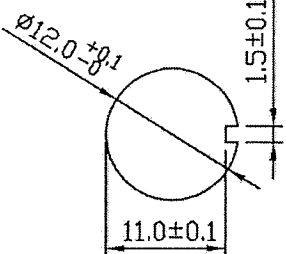
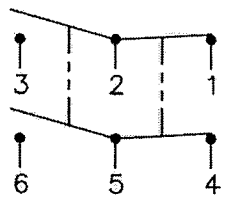

THIS INFORMATION IS CONFIDENTIAL AND PROPRIETARY TO CW INDUSTRIES INCORPORATED AND ITS AFFILIATES. IT MAY NOT BE DISCLOSED TO ANYONE, OTHER THAN CW INDUSTRIES PERSONNEL, WITHOUT WRITTEN AUTHORIZATION FROM CW INDUSTRIES INCORPORATED, SOUTHAMPTON, PENNSYLVANIA USA.

Rating	12(4)A 250V ac   US	Mounting Hole	Circuit Diagram
Contact Resistance	50m ohm Max.		
Insulation Resistance	DC 500V 100M ohm Min.		
Dielectric Strength	AC 1500V 1 minute		
Switch Function	6P DPDT ON-ON		
Operation Temperature	0°0~85°C		

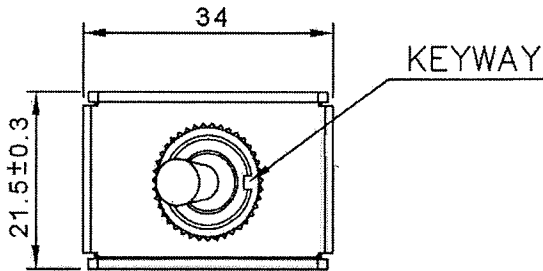

MATERIAL:
 Frame: Nylon 6/6, Black
 UL Flame: 94-V0
 Lever: Metal
 Terminal: Copper Alloy

Water proof and Dust Proof
 to fit IP-56

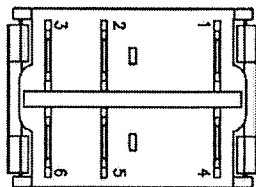
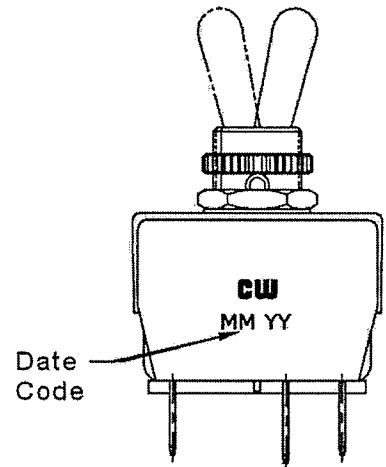
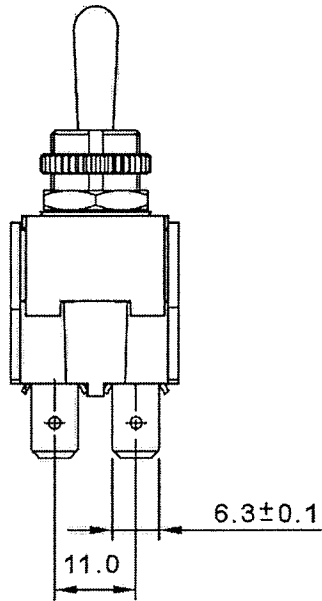
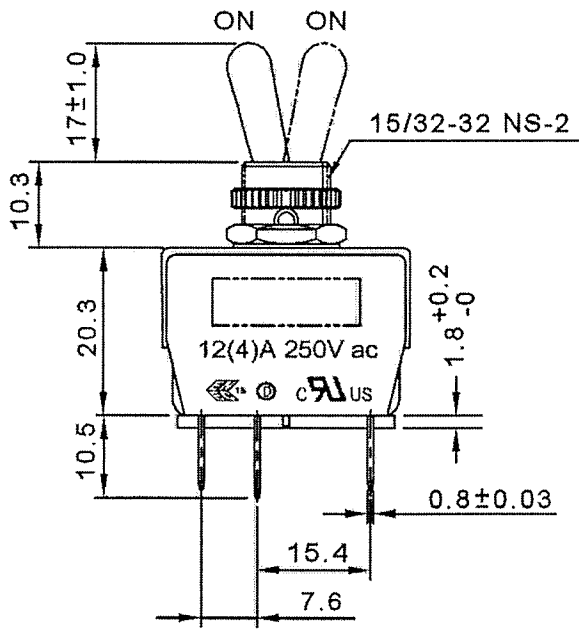

Tolerances Unless Otherwise Specified +/-0.5.

RoHS Compliant

5 Updated views, Materials & dimensions. 3-06-13.

CW INDUSTRIES
 Southampton, Pa. 18966
 Tel 215.355.7080/www.cwind.com

Date Drawn: 1/28/11

Rev. 5

Unit: mm

Checked By: *G. Guld*

Title:
TOGGLE SWITCH

CW P/N:
GTS448B101A1HR