



Chipsmall Limited consists of a professional team with an average of over 10 year of expertise in the distribution of electronic components. Based in Hongkong, we have already established firm and mutual-benefit business relationships with customers from,Europe,America and south Asia,supplying obsolete and hard-to-find components to meet their specific needs.

With the principle of “Quality Parts,Customers Priority,Honest Operation,and Considerate Service”,our business mainly focus on the distribution of electronic components. Line cards we deal with include Microchip,ALPS,ROHM,Xilinx,Pulse,ON,Everlight and Freescale. Main products comprise IC,Modules,Potentiometer,IC Socket,Relay,Connector.Our parts cover such applications as commercial,industrial, and automotives areas.

We are looking forward to setting up business relationship with you and hope to provide you with the best service and solution. Let us make a better world for our industry!



Contact us

Tel: +86-755-8981 8866 Fax: +86-755-8427 6832

Email & Skype: info@chipsmall.com Web: www.chipsmall.com

Address: A1208, Overseas Decoration Building, #122 Zhenhua RD., Futian, Shenzhen, China

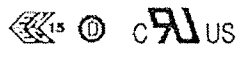
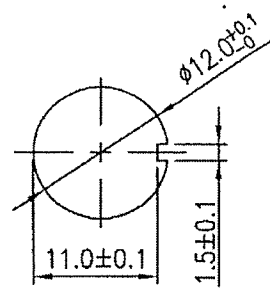
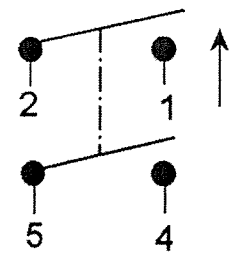

THIS INFORMATION IS CONFIDENTIAL AND PROPRIETARY TO CW INDUSTRIES INCORPORATED AND ITS AFFILIATES. IT MAY NOT BE DISCLOSED TO ANYONE, OTHER THAN CW INDUSTRIES PERSONNEL, WITHOUT WRITTEN AUTHORIZATION FROM CW INDUSTRIES INCORPORATED, SOUTHAMPTON, PENNSYLVANIA USA.

Rating	16(4)A 250V AC		Mounting Hole	Circuit
				
Contact Resistance	50m ohm Max.			
Insulation Resistance	DC 500V 100M ohm Min.			
Dielectric Strength	AC 1500V 1 minute			
Switch Function	4P DPST (ON) - OFF			
Operation Temp.	0° C ~ 85° C			

() = Momentary Function

MATERIAL:

Frame: Nylon 6/6, Black
UL Flame: 94-V0

Lever: Metal

Terminal: Copper Alloy

Water proof and Dust Proof
to fit IP-56

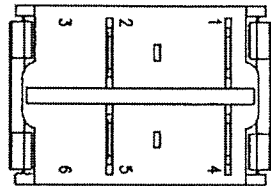
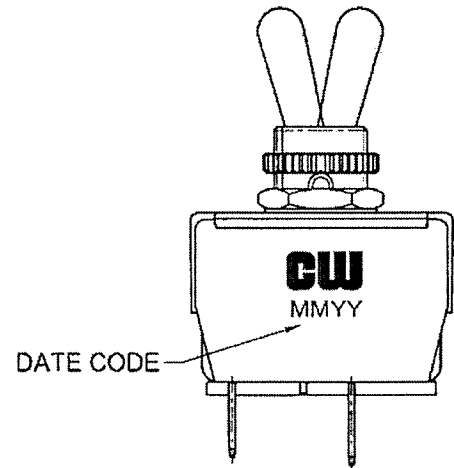
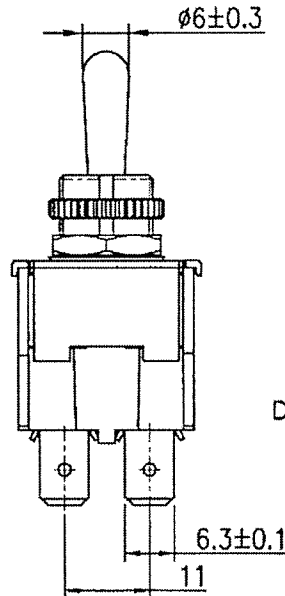
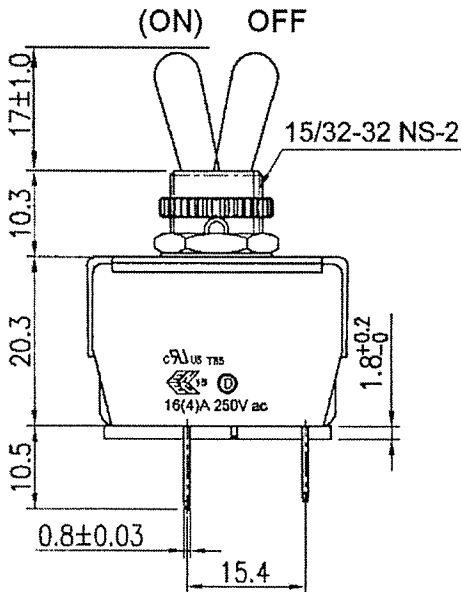
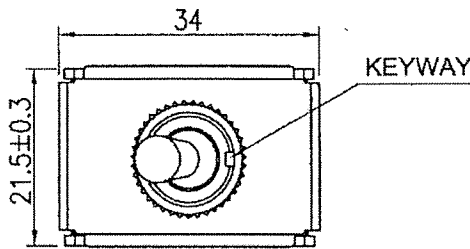

Tolerances Unless Otherwise Specified +/-0.5.

RoHS Compliant

1 Updated material notes. 3-21-13.

CW INDUSTRIES
Southampton, Pa. 18966
Tel 215.355.7080/www.cwind.com

Date Drawn: 8/13/12

Rev. 1

Unit: mm

Checked By: *G. Guld*

Title:
TOGGLE SWITCH

CW P/N:
GTS448S101AHR