



Chipsmall Limited consists of a professional team with an average of over 10 year of expertise in the distribution of electronic components. Based in Hongkong, we have already established firm and mutual-benefit business relationships with customers from,Europe,America and south Asia,supplying obsolete and hard-to-find components to meet their specific needs.

With the principle of “Quality Parts,Customers Priority,Honest Operation,and Considerate Service”,our business mainly focus on the distribution of electronic components. Line cards we deal with include Microchip,ALPS,ROHM,Xilinx,Pulse,ON,Everlight and Freescale. Main products comprise IC,Modules,Potentiometer,IC Socket,Relay,Connector.Our parts cover such applications as commercial,industrial, and automotives areas.

We are looking forward to setting up business relationship with you and hope to provide you with the best service and solution. Let us make a better world for our industry!



Contact us

Tel: +86-755-8981 8866 Fax: +86-755-8427 6832

Email & Skype: info@chipsmall.com Web: www.chipsmall.com

Address: A1208, Overseas Decoration Building, #122 Zhenhua RD., Futian, Shenzhen, China





GU2 SERIES SINGLE LED MODULE



FEATURES / BENEFITS

- ▲ Onboard drive accepts low voltage input
- ▲ Long life, up to 60,000 hours
- ▲ Low 1.5 watt power consumption
- ▲ Low profile - ADA compliant
- ▲ Optional niche mounting box available for direct burial in concrete or ground
- ▲ Uses the latest LUXEON® Rebel LED technology
- ▲ ETL listed to UL2108 standards for dry, damp or wet locations
- ▲ IP67 rated for interior or exterior use
- ▲ 40 lumen output for white. Consult factory for additional options

APPLICATIONS

Ideal for any difficult to maintain location low level pathway systems, architectural accent, staircases, decks, kitchens, etc. Easily mounts to wood, tile, stone, glass, stainless steel, etc

MATERIALS/FINISH

- ▲ Anodized aluminum base and “snap-on” top cover
- ▲ PMMA lens
- ▲ PTFE Lead Wires 20” (508mm) long, 20 AWG

OPERATING CONDITIONS

- ▲ Runs off 8-24 VDC or 10-14 VAC
- ▲ Current draw = 0.128A@ 12 VDC, 1.5 watts
- ▲ Multiple modules can be connected in parallel for longer runs off a single supply.
- ▲ Ambient Temperature limits -30°C to +55°C (-22°F to +131°F)

ORDERING INFORMATION

Guida 2 Base

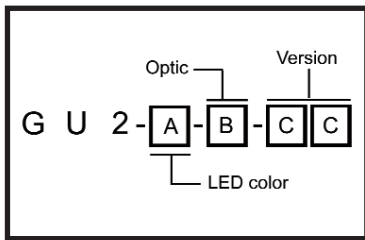

| LED Color (A) | Optical Pattern (B) | Version (CC) |
|--|---------------------|--|
| C = Cool White 5300K / *40 lumen min | D = Diffused | “Blank” = European Market Version |
| N = Neutral White 4000K / *40 lumen min | S = Spot | |
| W = Warm White 3050K / *40 lumen min | | |
| R = Red | | US = North America Version |
| G = Green | | |
| B = Blue | | |
| A = Amber | | |

Base & cover purchased separately

Guida 2 Covers

| Series - Cover Type |
|---------------------|
| GU - Dome |
| GU - Flush |
| GU - Eyelid |

Mounting Box

| |
|-------------------------------|
| GU-MBX = Euro version |
| GU-MBX-US = US version |

* LED flux data is manufacturers test data @ 25°C T_j. Light output at max acceptable ambient temp will be approximately 25-30% lower, depending on thermal conductivity of mounting surface and lens type.

Dialight Lumidrives

York House • Weatherby Road • Long Marston, York, YO26 7NH
Tel: 0845 6346161 • Fax: 0845 6346160 • www.dialight.com

**PRIVATE LABEL
OEM PROGRAM**

Dialight Corporation

1501 Route 34 South • Farmingdale, NJ 07727 USA

Tel: (1) 732-919-3119 • Fax: (1) 732-751-5778 • www.dialight.com



MDEXLUMGU2_B

MOUNTING INFORMATION

Mounting box for physical setting & stability. It is not waterproof, make connections with waterproof wire nuts.

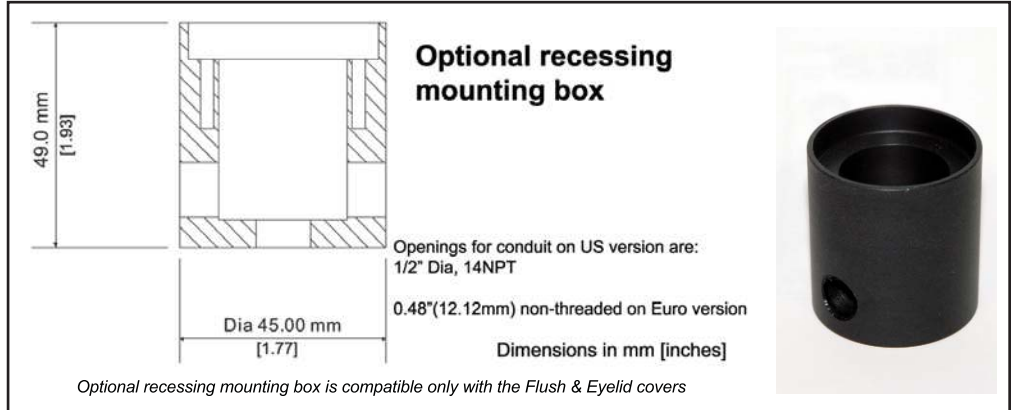
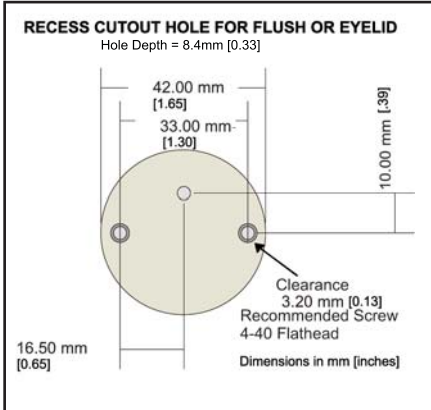

PHOTOMETRIC DATA

IES files available upon request

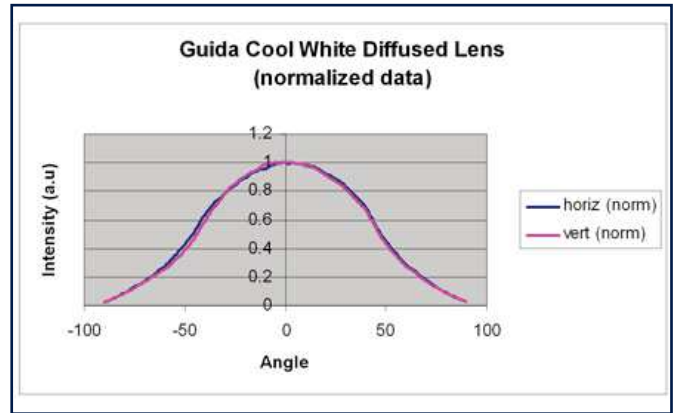
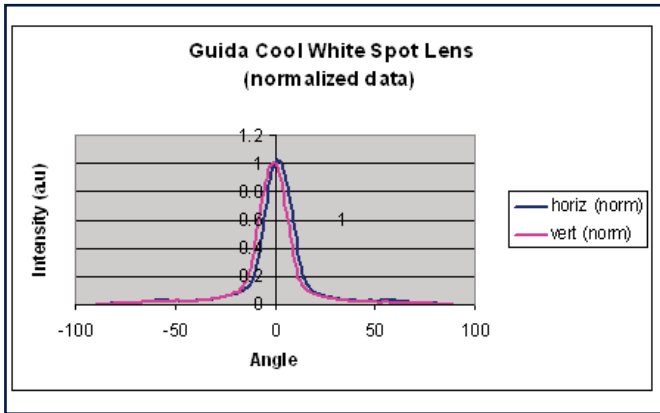

MECHANICAL DIMENSIONS

WIRING DIAGRAM

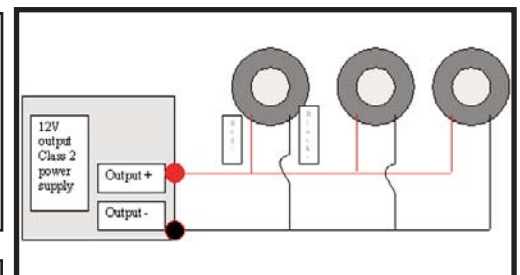
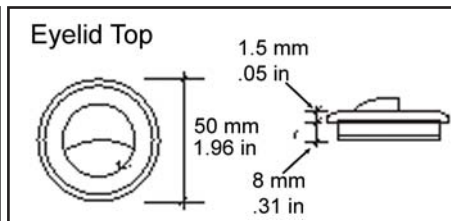
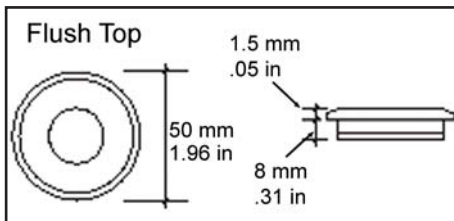
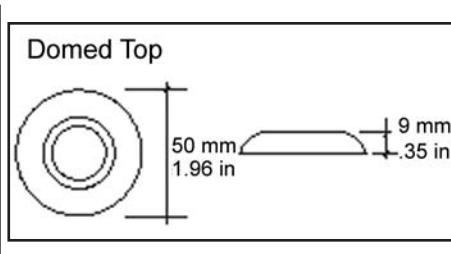
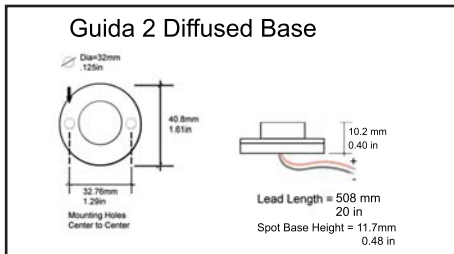

Dialight reserves the right to make changes at any time in order to supply the best product possible.

Eyelid top not compatible with spot base optic

PRIVATE LABEL OEM PROGRAM

Dialight Lumidrives

York House • Weatherby Road • Long Marston, York, YO26 7NH
Tel: 0845 6346161 • Fax: 0845 6346160 • www.dialight.com

Dialight Corporation

1501 Route 34 South • Farmingdale, NJ 07727 USA
Tel: (1) 732-919-3119 • Fax: (1) 732-751-5778 • www.dialight.com



MDEXLUMGU2_B