



Chipsmall Limited consists of a professional team with an average of over 10 year of expertise in the distribution of electronic components. Based in Hongkong, we have already established firm and mutual-benefit business relationships with customers from,Europe,America and south Asia,supplying obsolete and hard-to-find components to meet their specific needs.

With the principle of “Quality Parts,Customers Priority,Honest Operation,and Considerate Service”,our business mainly focus on the distribution of electronic components. Line cards we deal with include Microchip,ALPS,ROHM,Xilinx,Pulse,ON,Everlight and Freescale. Main products comprise IC,Modules,Potentiometer,IC Socket,Relay,Connector.Our parts cover such applications as commercial,industrial, and automotives areas.

We are looking forward to setting up business relationship with you and hope to provide you with the best service and solution. Let us make a better world for our industry!



## Contact us

Tel: +86-755-8981 8866 Fax: +86-755-8427 6832

Email & Skype: info@chipsmall.com Web: www.chipsmall.com

Address: A1208, Overseas Decoration Building, #122 Zhenhua RD., Futian, Shenzhen, China



Spec No.	DG-159015
Issue	30-May-16

## S P E C I F I C A T I O N S

Product Type ZENIGATA LED

Model No. GW6B\*X\*\*HD6

**\*X\*\* : MX27, MX30, MX40**

**GX27, GX30, GX40**

※These specifications contain 19 pages including the cover and appendix.  
If you have any objections, please contact us before issuing purchasing order.

CUSTOMERS ACCEPTANCE

**Reference**

DATE: \_\_\_\_\_

BY: \_\_\_\_\_

PRESENTED

BY: \_\_\_\_\_

Dept. General Manager

REVIEWED BY: \_\_\_\_\_ PREPARED BY: \_\_\_\_\_

Development Department II  
Lighting Device Business Unit  
Electronic Components And Devices Company  
SHARP CORPORATION

1. These specification sheets include materials protected under copyright of Sharp Corporation ("Sharp"). Please handle with great cares and do not reproduce or cause anyone to reproduce them without Sharp's consent.
2. When using this Sharp product, please observe the absolute maximum ratings, other conditions and instructions for use described in the specification sheets, as well as the precautions mentioned below.  
Sharp assumes no responsibility for any damages resulting from use of the product which does not comply with absolute maximum ratings, other conditions and instructions for use included in the specification sheets, and the precautions mentioned below.

(Precautions)

- (1) In making catalogue or instruction manual based on the specification sheets, please verify the validity of the catalogue or instruction manuals after assembling Sharp products in customer's products at the responsibility of customer.
- (2) This Sharp product is designed for use in the following application areas ;
  - Computers • OA equipment • Telecommunication equipment (Terminal) • Measuring equipment
  - Tooling machines • Audio visual equipment • Home appliancesIf the use of the Sharp product in the above application areas is for equipment listed in paragraphs (3) or (4), please be sure to observe the precautions given in those respective paragraphs.
- (3) Appropriate measures, such as fail-safe design and redundant design considering the safety design of the overall system and equipment, should be taken to ensure reliability and safety when Sharp product is used for equipment in responsibility of customer which demands high reliability and safety in function and precision, such as ;
  - Transportation control and safety equipment (aircraft, train, automobile etc.)
  - Traffic signals • Gas leakage sensor breakers • Rescue and security equipment
  - Other safety equipment
- (4) Sharp product is designed for consumer goods and controlled as consumer goods in production and quality. Please do not use this product for equipment which require extremely high reliability and safety in function and precision, such as ;
  - Space equipment • Telecommunication equipment (for trunk lines)
  - Nuclear power control equipment • Medical equipment
- (5) Please contact and consult with a Sharp sales representative if there are any question regarding interpretation of the above four paragraphs.

3. Disclaimer

The warranty period for Sharp product is one (1) year (or six (6) months in case of generalized product) after shipment. During the period, if there are any products problem, Sharp will repair (if applicable), replace or refund. Except the above, both parties will discuss to cope with the problems.

The failed Sharp product after the above one (1) year ( or six (6) month for generalized product) period will be coped with by Sharp, provided that both parties shall discuss and determine on sharing responsibility based on the analysis results thereof subject to the above scope of warranty.

The warranty described herein is only for Sharp product itself which are purchased by or delivered to customer. Damages arising from Sharp product malfunction or failure shall be excepted.

Sharp will not be responsible for the Sharp product due to the malfunction or failures thereof which are caused by:

- (1) storage keep trouble during the inventory in the marketing channel.
- (2) intentional act, negligence or wrong/poor handling.
- (3) equipment which Sharp products are connected to or mounted in.
- (4) disassembling, reforming or changing Sharp products.
- (5) installation problem.
- (6) act of God or other disaster (natural disaster, fire, flood, etc.)
- (7) external factors (abnormal voltage, abnormal electromagnetic wave, fire, etc.)
- (8) special environment (factory, coastal areas, hotspring area, etc.)
- (9) phenomenon which cannot be foreseen based on the practical technologies at the time of shipment.
- (10) the factors not included in the product specification sheet.

4. Please contact and consult with a Sharp sales representative for any questions about Sharp product.

## GW6B\*X\*\*HD6 specifications

### 1. Application

These specifications apply to the light emitting diode module Model No. GW6B\*X\*\*HD6.

[ LED module (InGaN Blue LED chip + Phosphor) ]

Main application : Lighting

### 2. External dimensions and equivalent circuit ----- Refer to Page 2

### 3. Ratings and characteristics ----- Refer to Page 3- 6.

3-1. Absolute maximum ratings

3-2. Electro-optical characteristics

3-3. Derating curve

### 4. Reliability ----- Refer to Page 7

4-1. Test items and test conditions

4-2. Failure criteria

### 5. Quality level ----- Refer to Page 8

5-1. Applied standard

5-2. Sampling inspection

5-3. Inspection items and defect criteria

### 6. Supplements----- Refer to Page 9- 13.

6-1. Chromaticity rank table

6-2. Packing

6-3. Label

6-4. Indication printed on product

### 7. Precautions ----- Refer to Page 14- 16.

### 8. Characteristics diagram (TYP.) ----- Refer to Page 17

2. External dimensions and equivalent circuit

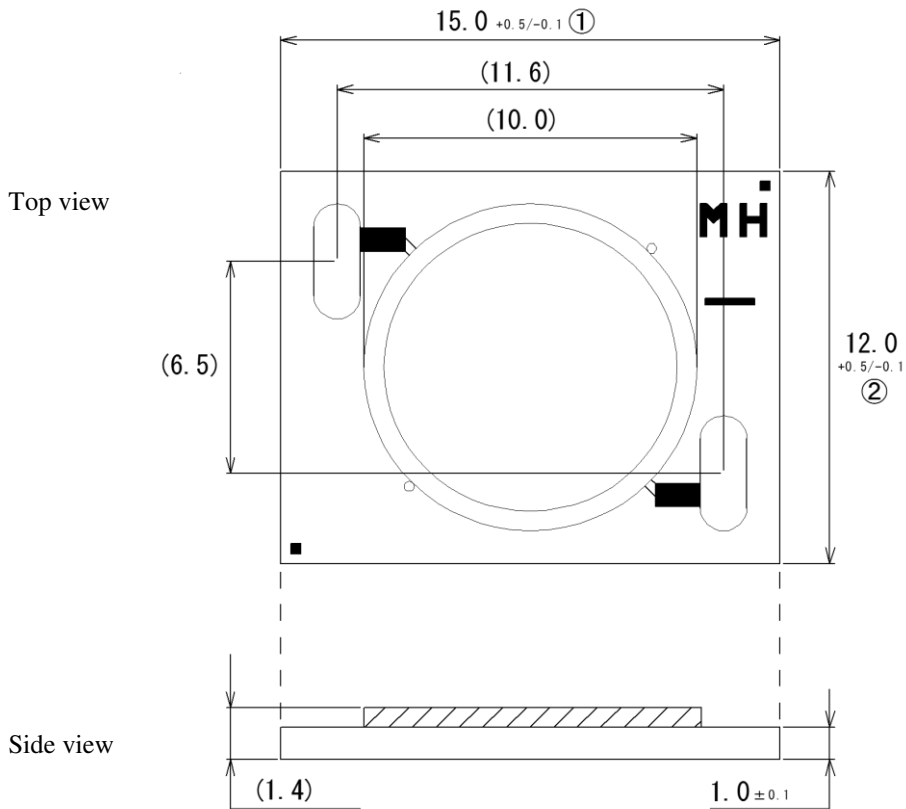

(Note) Values inside parentheses are reference values.  
External sizes of ①, ② are determined by maximum dimensions, that include salient areas on the edges of respective sides.

Equivalent circuit

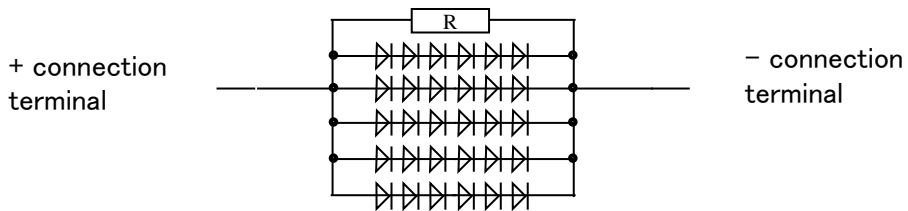

(Note) 6 series × 5 parallel = 30 pcs of LEDs

Unit	Material	Drawing No.
mm	Substrate : Alumina Ceramic	52709012

### 3. Ratings and characteristics

#### 3-1. Absolute maximum ratings

Item	Symbol	Rating	Unit
Power Dissipation *1,4	P	19.0	W
Forward Current *1,4	I <sub>F</sub>	1000	mA
Reverse Voltage *2,4	V <sub>R</sub>	-15	V
Operating Temperature *3	T <sub>opr</sub>	- 30 ~ + 100	°C
Storage Temperature	T <sub>stg</sub>	- 40 ~ + 100	°C
Junction Temperature	T <sub>j</sub>	145	°C

\*1 Power dissipation and forward current are the values when the module temperature is set lower than the rating by using an adequate heat sink.

\*2 The maximum rating of reverse voltage is assumed, after considering the voltage that occur due to initial connection error that may occur suddenly.

(Not dealing with the possibility of always-on reverse voltage.)

\*3 Operating temperature is the Case temperature T<sub>c</sub>

(Refer to measuring point for case temperature in the next page.)

Refer to "Derating curve" in the next page as for operating current.

\*4 T<sub>c</sub> = 25 °C

## 3-2. Electro-optical characteristics

( Tj = 90 °C )

MX**	Item	Symbol	Condition			MIN.	TYP.	MAX.	Unit
common	Forward Voltage *5	V <sub>F</sub>	I <sub>F</sub> =	500	mA	15.6	(17.3)	19	V
27	Luminous Flux *6	Φ	I <sub>F</sub> =	500	mA	900	(1000)	-	lm
	Chromaticity Coordinates *7	x				-	(0.4610)	-	-
		y				-	(0.4150)	-	-
	Color Temperature	-				-	(2720)	-	K
General Color Rendering Index *8	R <sub>a</sub>	80	(83)	-	-				
30	Luminous Flux *6	Φ	I <sub>F</sub> =	500	mA	960	(1070)	-	lm
	Chromaticity Coordinates *7	x				-	(0.4370)	-	-
		y				-	(0.4030)	-	-
	Color Temperature	-				-	(2990)	-	K
General Color Rendering Index *8	R <sub>a</sub>	80	(83)	-	-				
40	Luminous Flux *6	Φ	I <sub>F</sub> =	500	mA	1000	(1115)	-	lm
	Chromaticity Coordinates *7	x				-	(0.3820)	-	-
		y				-	(0.3800)	-	-
	Color Temperature	-				-	(3980)	-	K
General Color Rendering Index *8	R <sub>a</sub>	80	(83)	-	-				

(Note) Values inside parentheses are shown for reference purpose only.

\*5 (After 5 ms drive, Measurement tolerance: ± 3 %)

\*6 Monitored by Sharp's 1m integrating sphere and Otsuka electronics SR-2000A  
(After 5 ms drive, Measurement tolerance: ± 10 %)\*7 Monitored by Sharp's 1m integrating sphere and Otsuka electronics SR-2000A  
(After 5 ms drive, Measurement tolerance: ± 0.005)\*8 Monitored by Sharp's 1m integrating sphere and Otsuka electronics SR-2000A  
(After 5 ms drive, Measurement tolerance: ± 2)

( Tj = 90 °C )

GX**	Item	Symbol	Condition			MIN.	TYP.	MAX.	Unit
common	Forward Voltage *5	V <sub>F</sub>	I <sub>F</sub> =	500	mA	15.6	(17.3)	19	V
27	Luminous Flux *6	Φ	I <sub>F</sub> =	500	mA	760	(845)	-	lm
	Chromaticity Coordinates *7	x				-	(0.4610)	-	-
		y				-	(0.4150)	-	-
	Color Temperature	-				-	(2720)	-	K
General Color Rendering Index *8	Ra	90	(93)	-	-				
30	Luminous Flux *6	Φ	I <sub>F</sub> =	500	mA	810	(905)	-	lm
	Chromaticity Coordinates *7	x				-	(0.4370)	-	-
		y				-	(0.4030)	-	-
	Color Temperature	-				-	(2990)	-	K
General Color Rendering Index *8	Ra	90	(93)	-	-				
40	Luminous Flux *6	Φ	I <sub>F</sub> =	500	mA	860	(960)	-	lm
	Chromaticity Coordinates *7	x				-	(0.3820)	-	-
		y				-	(0.3800)	-	-
	Color Temperature	-				-	(3980)	-	K
General Color Rendering Index *8	Ra	90	(93)	-	-				

(Note) Values inside parentheses are shown for reference purpose only.

\*5 (After 5 ms drive, Measurement tolerance: ± 3 %)

\*6 Monitored by Sharp's 1m integrating sphere and Otsuka electronics SR-2000A  
(After 5 ms drive, Measurement tolerance: ± 10 %)\*7 Monitored by Sharp's 1m integrating sphere and Otsuka electronics SR-2000A  
(After 5 ms drive, Measurement tolerance: ± 0.005)\*8 Monitored by Sharp's 1m integrating sphere and Otsuka electronics SR-2000A  
(After 5 ms drive, Measurement tolerance: ± 2)



3-3. Derating curve

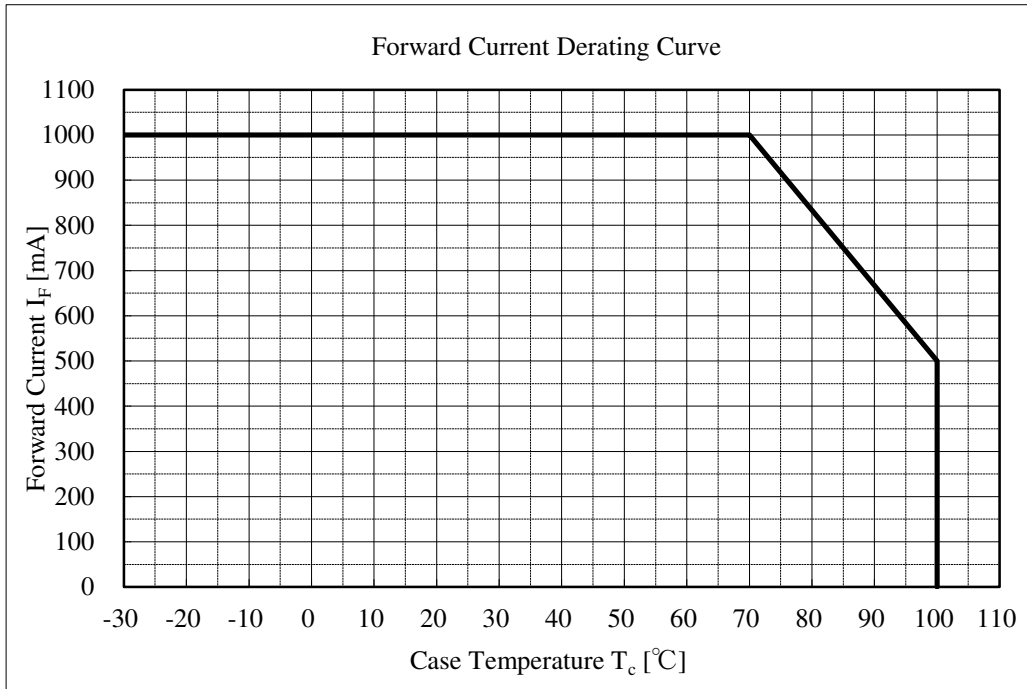

(Note) To keep the case temperature lower than the rating, enough heat-radiation performance needs to be secured by using an adequate heat sink (refer to section 7-③).

For soldering connection, please evaluate in your usage environment to make sure soldering reliability.  
 ( Above derating curve is specified to LED device, not for soldering connection )  
 And please consider to avoid physical stress between wire and substrate,  
 and some protection like silicon bond on top of soldered wire is recommended.

Please ensure the maintenance of heat radiation does not exceed case temperature over the rating in operation.

(Measuring point for case temperature)

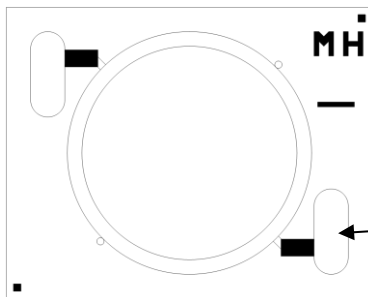

Please take note of the following, when measuring case temperature.  
 1 The LED device mounting surface should be flat/plain surface.  
 2 The substrate surface temperature should be uniform.

Thermal Resistance: 2.9 °C/W(Typical value)

## 4. Reliability

The reliability of products shall be satisfied with items listed below.

### 4-1. Test items and test conditions

Confidence level: 90 %

No.	Test item	Test conditions	Samples n	Defective C	LTPD (%)
1	Temperature Cycle	- 40 °C(30 min) ~ + 100 °C(30 min), 100 cycles	11	0	20
2	Temperature Humidity Storage	T <sub>stg</sub> = + 60 °C, RH = 90 %, Time = 1000 h	11	0	20
3	High Temperature Storage	T <sub>stg</sub> = + 100°C, Time = 1000 h	11	0	20
4	Low Temperature Storage	T <sub>stg</sub> = - 40 °C, Time = 1000 h	11	0	20
5	Steady State Operating Life	Tc = 90 °C, IF = 660 mA, Time = 1000 h	11	0	20
6	Shock	Acceleration: 15000 m/s <sup>2</sup> , Pulse width: 0.5 ms Direction: 3 directions (X, Y and Z) 3 trials in each direction	5	0	50
7	Vibration	Frequency: 100 to 2000 Hz for 4 minutes per trial Acceleration: 200 m/s <sup>2</sup> Direction: 3 directions (X, Y and Z) 4 trials in each direction	5	0	50

### 4-2. Failure criteria

No.	Parameter	Symbol	Failure criteria
1	Forward Voltage	V <sub>F</sub>	V <sub>F</sub> > Initial value × 1.1
2	Luminous Flux	Φ	Φ < Initial value × 0.7

## 5. Quality level

5-1. Applied standard  
ISO2859-1

5-2. Sampling inspection  
A single normal sampling plan, level S-4.

### 5-3. Inspection items and defect criteria

No.	Item	Defect criteria	Classification	AQL
1	No radiation	No light emitting	Major defect	0.1
2	Electro-optical characteristics	Not conforming to the specification (Forward voltage, Luminous flux and Chromaticity values)	Minor defect	0.4
3	External dimensions	Not conforming to the specified dimensions (External dimensions of ① and ② shown in Page 2)		
4	Appearance	Nonconformity observed in product appearance is determined as defective only when electro-optical characteristics is affected by. <If any question arises regardless of above mentioned criterion> <ul style="list-style-type: none"> <li>■ Foreign material, scratch, or bubble at emitting area: 0.8 mm φ</li> <li>■ Fiber generation at emitting area: 0.2 mm in width and 2.5 mm in length</li> <li>■ Foreign material at connection terminal: 0.8 mm φ</li> <li>■ Substrate burr on edge: Over dimension tolerance</li> </ul>		

(Note) Products with removable foreign material attached on are not determined to be defective.

(Note) Substrate cracks that do not effect the electrical/optical charecteristics are not determined to be defective.

6. Supplements

6-1. Chromaticity rank table

(Tolerance:  $x, y \pm 0.005$ )

2700K

(IF = 500 mA,  $T_j = 90\text{ }^\circ\text{C}$ )

Color Region	Center Point ( x , y )		Oval parameter		
			Major Axis a	Minor Axis b	Ellipse Rotation Angle $\theta$
3-step MacAdam ellipse	0.4610	0.4150	0.00774	0.00411	57.28

- \* Color region stay within MacAdam 3-step ellipse from the chromaticity center.
- \*  $\theta$  is the angle between the major axis of the ellipse and the x-axis, and a and b are the major and minor semi-axes of an ellipse.(Ref. IEC 60081:1997 AnnexD)

Chromaticity Diagram

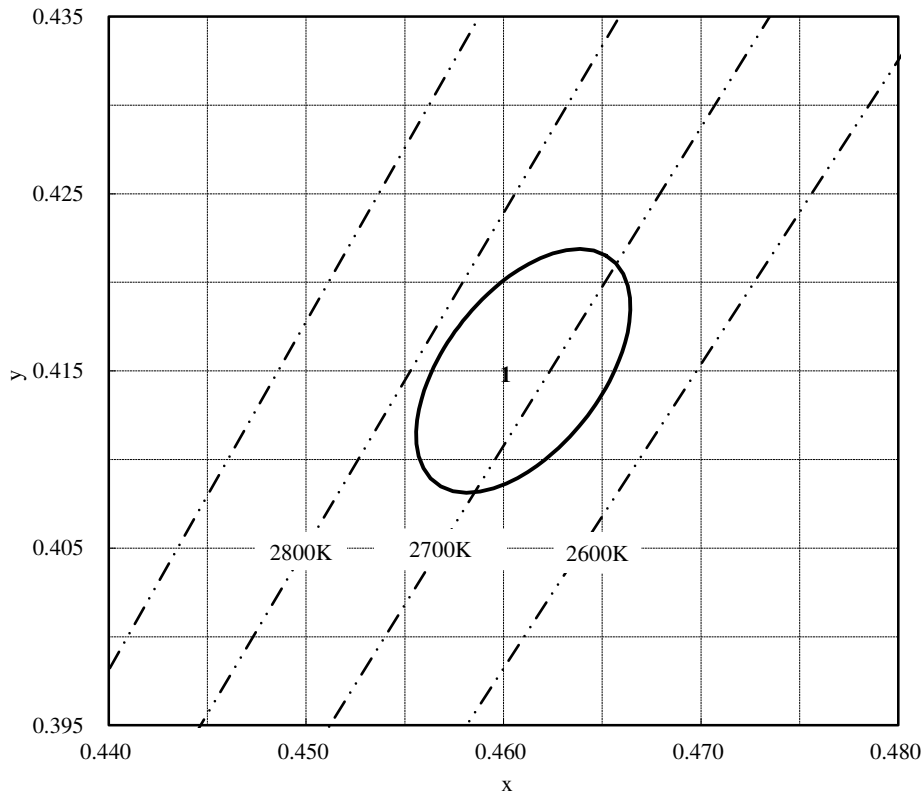

(Tolerance: x,y ± 0.005)

3000K

(IF = 500 mA, Tj = 90 °C)

Color Region	Center Point ( x , y )		Oval parameter		
			Major Axis a	Minor Axis b	Ellipse Rotation Angle θ
3-step MacAdam ellipse	0.4370	0.4030	0.00834	0.00408	53.17

- \* Color region stay within MacAdam 3-step ellipse from the chromaticity center.
- \* θ is the angle between the major axis of the ellipse and the x-axis, and a and b are the major and minor semi-axes of an ellipse.(Ref. IEC 60081:1997 AnnexD)

Chromaticity Diagram

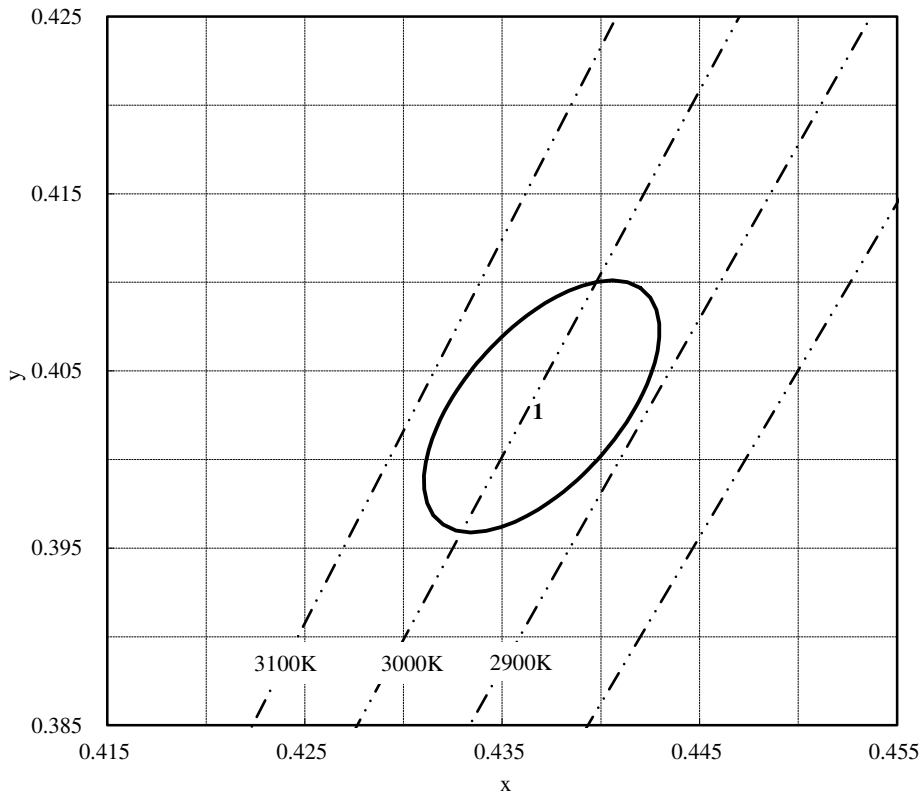

(Tolerance: x,y ± 0.005)

4000K

(IF = 500 mA, Tj = 90 °C)

Color Region	Center Point ( x , y )		Oval parameter		
			Major Axis a	Minor Axis b	Ellipse Rotation Angle θ
3-step MacAdam ellipse	0.3820	0.3800	0.00939	0.00402	54.00

- \* Color region stay within MacAdam 3-step ellipse from the chromaticity center.
- \* θ is the angle between the major axis of the ellipse and the x-axis, and a and b are the major and minor semi-axes of an ellipse.(Ref. IEC 60081:1997 AnnexD)

Chromaticity Diagram

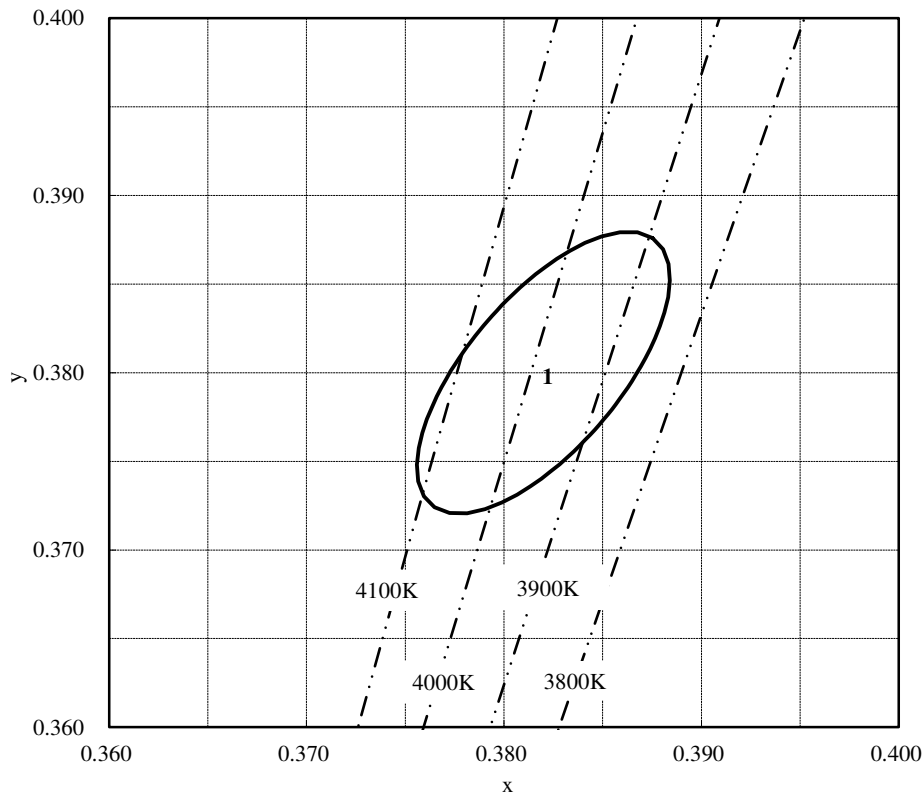

6-2. Packing

- One tray composed of 80 pieces
  - 5 trays (400 pieces) and one upper lid-tray in one moisture-proof bag
  - 2 bags (800 pieces) in one carton
  - Dimensions of outer carton: 235 × 220 × 90 mm (Reference value)
- (Note 1) There are cases of one carton composed of one bag. (400 pieces)  
 (Note 2) State of packing is subject to change.

< Outer carton >

400 pieces × 2 bags = 800 pieces

< One bag >

80 pieces × 5 trays = 400 pieces

< One tray >

10 × 8 = 80 pieces

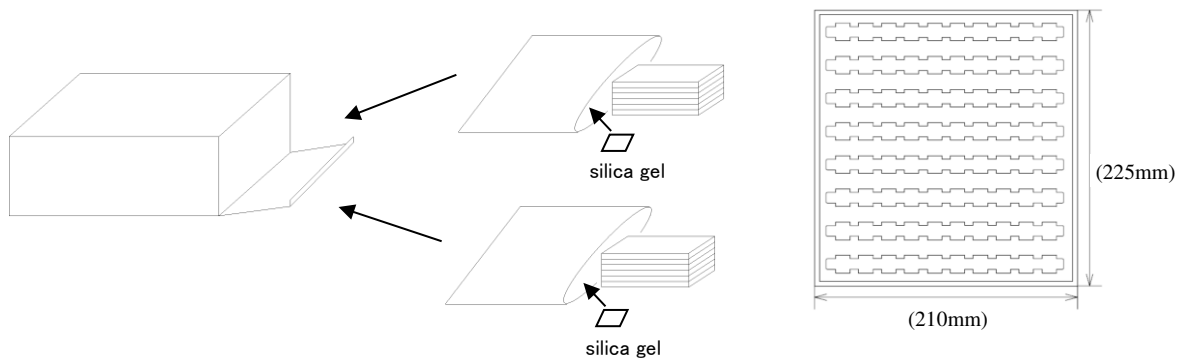

6-3. Label

1) Outer carton

Following label is attached on outer carton.

(Note 3) Label format is subjected to change.

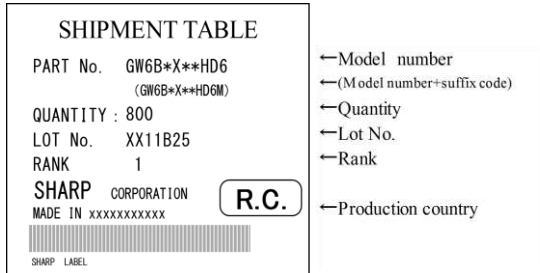

1) Lot No. indication

XX 11 B 25

① ② ③ ④

- ① Production plant code A
- ② Shipping year (Year last 2 digits)
- ③ Shipping month  
(from January to December in ABC order)
- ④ Shipping date (01~31)

\*Notation may be different

2) Moisture-Proof bag

Following label is attached on moisture-proof bags.

(Note 3) Label format is subjected to change.

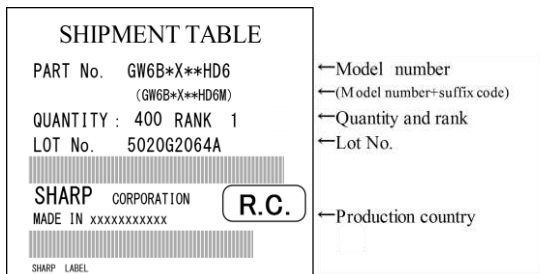

1) Lot No. indication

XX 1 9 G 11 123 A

① ② ③ ④ ⑤ ⑥ ⑦

- ① Production plant code B
- ② Shipping year (Year last digit)
- ③ Shipping month (1~9 or O, N, D)
- ④ Fixed code G
- ⑤ Shipping date (01~31)
- ⑥ Serial No.
- ⑦ Backup code A

\*Notation may be different

6-4. Indication printed on product

Model No. and control No. are indicated on substrate surface.

1) Control No.

Indicated as follows;

\*X\*\*6 - 1 F 11

① ② ③ ④

- ① Abbreviated Model No.
- ② Chromaticity Rank
- ③ Month of production  
(to be indicated alphabetically with January corresponding to A)
- ④ Date of production (01~31)

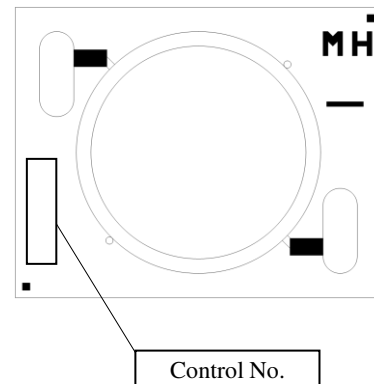



## 7. Precautions

### ① Storage conditions

Please follow the conditions below.

- Before opened: Temperature 5 ~ 30 °C, Relative humidity less than 60 %.  
(Before opened LED should be used within a year)
- After opened: Temperature 5 ~ 30 °C, Relative humidity less than 60 %.  
(Please apply soldering within 1 week)
- After opened LED should be kept in an aluminum moisture proof bag with a moisture absorbent material (silica gel).
- Avoid exposing to air with corrosive gas.

If exposed, electrode surface would be damaged, which may affect soldering.

### ② Usage conditions

This product is not designed for the use under any of the following conditions.

Please carefully check the performance and reliability well enough in case of using under any of the following conditions;

- In a place with a lot of moisture, dew condensation, briny air, and corrosive gas.  
(Cl, H<sub>2</sub>S, NH<sub>3</sub>, SO<sub>2</sub>, NOX, etc.)
- Under the direct sunlight, outdoor exposure, and in a dusty place.
- In water, oil, medical fluid, and organic solvent.

Please do not use component parts like rubber which may contain sulfur (gasket packing, adhesive material, etc.).

Please note that any strong acidic or alcoholic elements could effect the silicon resin used in the LED device. The heat and light released from the LED device, could generate halogen gas from the surrounding materials, which may have adverse impact on the module. Before using please consider carefully about this issue.

### ③ Heat radiation and Installation

If forward current (IF) is applied to single-state module at any current, there is a risk of damaging LED or emitting smoke, due to increase in temperature.

Equip with specified heat radiator(heat sink), and avoid heat being stuffed inside the module.

Material of substrate is alumina ceramic. If installed inappropriately, trouble of insufficient heat radiation may occur, which may result in board cracks or lighting defects due to overheat. Please take particular notice for installation.

Refer to the following cautions while installing the LED device on heat sink.

- Apply thermolysis adhesive, adhesive sheet or peculiar connector when mounted on heat radiator.  
In case of applying adhesive or adhesive sheet only, check the effectiveness and reliability before fixing.  
If LED comes off from heat radiator, unusual temperature rise entails hazardous phenomena including device deterioration, coming off of solder at leads, and emitting smoke, along with LED device defects.
- When LED device is mechanically fixed or locked, Please take into consideration regarding the method of attachment due to fail from stress.
- Please apply appropriate stress and design carefully, when fixing the LED device using holder. Any excessive or uneven stress could break LED device's substrate.
- Avoid convexly uneven boards.  
Convex board is subject to substrate cracking or debasement of heat release.
- It is recommended to apply adhesive or adhesive sheet with high thermal conductivity for radiation of heat effectively.
- Please take care about the influence of color change of adhesive or adhesive sheet in initial and long term period, which may affect light output or color due to change of reflectance from backside.

- Any excessive or uneven stress on the ceramic substrate could break the substrate. Please design such that, proper/uniform stress is applied on the substrate, when fixing the LED device using a holder.
- When fixing the LED device with a holder, please take note if any excessive or uneven stress is applied when pressing the substrate with holder. Due to this, the gap may arise between LED device and adhesive material, which may affect the heat dissipation of the device.
- Do not touch resin part including white resin part on the surface of LED.

No light emission may occur due to damage of resin or cutting wire of LEDs by outer force.

When using tweezers, please handle by ceramic substrate part and avoid touching resin part.

For mounting, please handle by side part of ceramic or the specified area shown below.

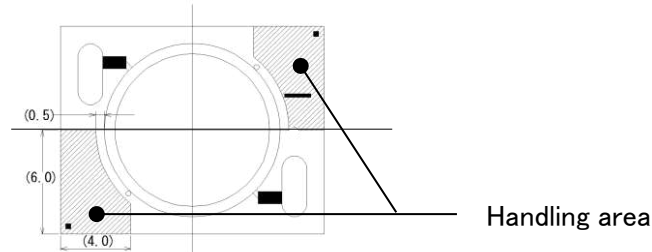

- The outer edges of the substrate may be uneven in some cases. Please avoid choosing these areas as fixing points, while designing for installation.
- In case of using heat radiation sheet or heat radiation adhesive, light reflection or absorption of these materials may influence the output of LED device. Especially, the color change that occur due to long-term use has direct impact on output of LED devices, and hence careful consideration is required while choosing the radiation sheet or adhesive.
- Please avoid using any materials (such as PBT resin) that may release corrosive gases, around LED device.

#### ④ Connecting method

Use soldering for connections. Follow the conditions mentioned below, to preserve the connection strength.

- Use soldering iron with thermo controller (tip temperature 380 °C), within 5 seconds per one place.
- Secure the solder wettability on whole solder pad and leads.
- During the soldering process, put the ceramic board on materials whose conductivity is poor enough not to radiate heat of soldering.
- Warm up (with using a heated plate) the substrate is recommended before soldering.  
( preheat condition: 100 °C ~ 150 °C, within 60 sec )
- Avoid touching any part of resin with soldering iron.
- This product is not designed for reflow and flow soldering.
- Avoid such lead arrangement as applying stress to solder-applied area.
- Please do not detach solder and make re-solder.
- Please solder evenly on each electrode.
- Please prevent flux from touching to resin.
- Do the soldering on stable stand. Avoid soldering on moving or vibrating objects.
- Please avoid touching the soldering unit to resin.

#### ⑤ Static electricity

This product is subject to static electricity, so take measures like wearing wrist band to cope with it. Install circuit protection device to drive circuit, if necessary.

⑥ Drive method

- Any reverse voltage cannot be applied to LEDs when they are in operation or not.

Design a circuit so that any flow of reverse or forward voltage can not be applied to LEDs when they are out of operation.

- Module is composed of LEDs connected in both series and parallel.

Constant voltage power supply runs off more than specified current amount due to lowered VF caused by temperature rise. Constant current power supply is recommended to drive.

- Be cautious while putting on/off the power supply, as excess current, excess voltage or reverse voltage may get injected to the device in some cases.

⑦ Cleaning

Avoid cleaning, since LED device may be effected in some cases by cleaning.

⑧ Color-tone variation

Chromaticity of this product is monitored by integrating sphere right after the operation.

Chromaticity varies depending on measuring method, light spread condition, or ambient temperature.

Please verify your actual conditions before use.

⑨ Safety

- Looking directly at LEDs for a long time may result in hurting your eyes.

- In case that excess current (over ratings) is supplied to the device, hazardous phenomena including abnormal heat generation, emitting smoke, or catching fire can be caused.

Take appropriate measures to excess current and voltage.

- In case of solder connecting method, there is a possibility of fatigue failure by heat.

Please fix the leads in such case to protect from short circuit or leakage of electricity caused by contact.

- Please confirm the safety standards or regulations of application devices.

- Please be careful with substrate edges, that may injure your hands.

⑩ Other cautions

Guarantee covers the compliance to the quality standards mentioned in the specifications, however it does not cover the compatibility with application of the end-use, including assembly and usage environment.

In case any quality problems occurred in the application of end-use, details will be separately discussed and determined between the parties hereto.

8. Characteristics diagram (TYP.)

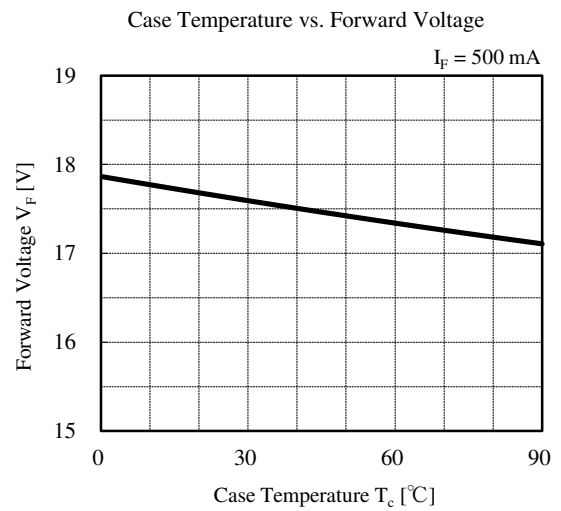
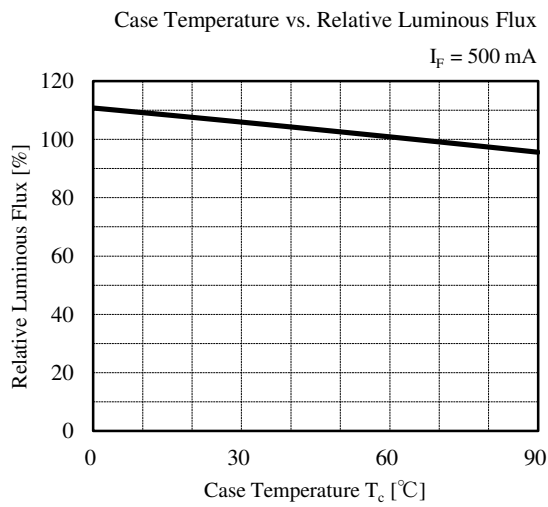
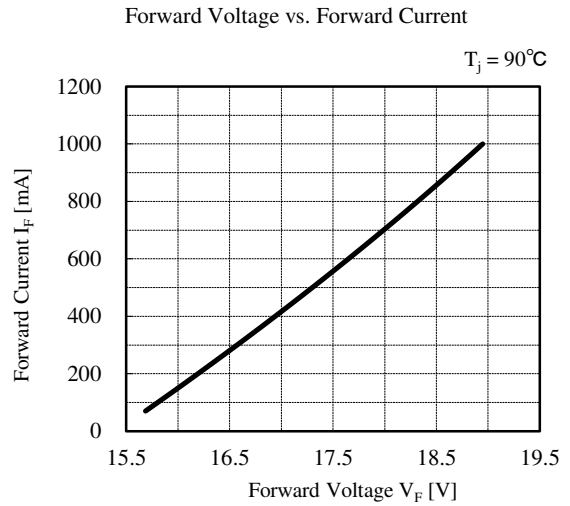
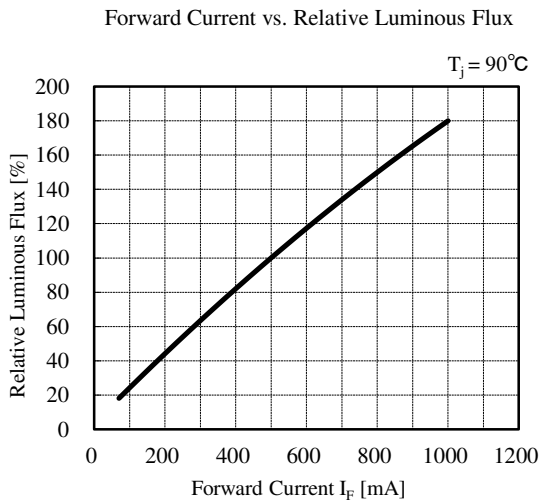

(Note) Characteristics data shown here are for reference purpose only. (Not guaranteed data)