



Chipsmall Limited consists of a professional team with an average of over 10 year of expertise in the distribution of electronic components. Based in Hongkong, we have already established firm and mutual-benefit business relationships with customers from,Europe,America and south Asia,supplying obsolete and hard-to-find components to meet their specific needs.

With the principle of “Quality Parts,Customers Priority,Honest Operation,and Considerate Service”,our business mainly focus on the distribution of electronic components. Line cards we deal with include Microchip,ALPS,ROHM,Xilinx,Pulse,ON,Everlight and Freescale. Main products comprise IC,Modules,Potentiometer,IC Socket,Relay,Connector.Our parts cover such applications as commercial,industrial, and automotives areas.

We are looking forward to setting up business relationship with you and hope to provide you with the best service and solution. Let us make a better world for our industry!



## Contact us

Tel: +86-755-8981 8866 Fax: +86-755-8427 6832

Email & Skype: info@chipsmall.com Web: www.chipsmall.com

Address: A1208, Overseas Decoration Building, #122 Zhenhua RD., Futian, Shenzhen, China



# GX SERIES

- FIBER SENSORS
- LASER SENSORS
- PHOTOELECTRIC SENSORS
- MICRO PHOTOELECTRIC SENSORS
- AREA SENSORS
- LIGHT CURTAINS / SAFETY COMPONENTS
- PRESSURE / FLOW SENSORS
- INDUCTIVE PROXIMITY SENSORS**
- PARTICULAR USE SENSORS
- SENSOR OPTIONS
- SIMPLE WIRE-SAVING UNITS
- WIRE-SAVING SYSTEMS
- MEASUREMENT SENSORS
- STATIC ELECTRICITY PREVENTION DEVICES
- LASER MARKERS
- PLC
- HUMAN MACHINE INTERFACES
- ENERGY CONSUMPTION VISUALIZATION COMPONENTS
- FA COMPONENTS
- MACHINE VISION SYSTEMS
- UV CURING SYSTEMS

Related Information	■ General terms and conditions..... F-7	■ Sensor selection guide ..... P.803~
	■ Glossary of terms..... P.1482~	■ General precautions ..... P.1485~



[panasonic.net/id/pidsx/global](http://panasonic.net/id/pidsx/global)

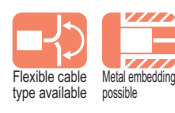

## Robust enclosure and flexible cable types are also available

### VARIETIES

#### Miniature

**GX-3S**□

The **GX-3S**□ is an amplifier built-in inductive proximity sensor having a diameter of just  $\varnothing 3.8$  mm  $\varnothing 0.150$  in.



#### Robust housing

**GX-4S**□

The **GX-4S**□ uses a robust stainless steel enclosure. The tightening torque can be 0.58 N·m or less. (2 times compared with conventional models)

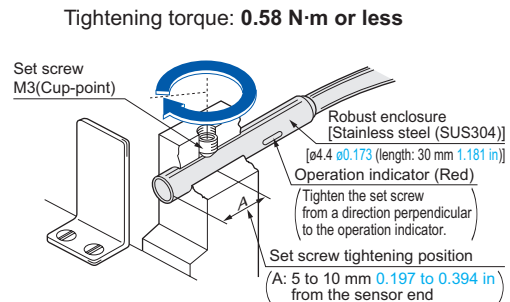

### BASIC PERFORMANCE

#### Long sensing range

**GX-8ML**□

The non-shielded type (**GX-8ML**□) has twice the sensing range of the shielded type (**GX-8M**□), although having the same size. Hence, it allows margin against sensing distance variations.

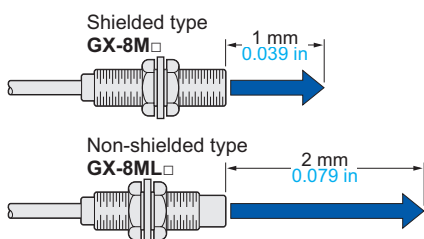

### ENVIRONMENTAL RESISTANCE

#### Ten times greater bending durability (Compared with conventional models)

**GX-□-R**

The bending durability of the cable to repeated bending has been increased tenfold by using special alloy cores for the cable.

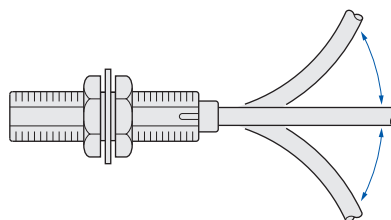

- Selection Guide
- Amplifier Built-in
- Amplifier-separated
- GX-F/H
- GXL
- GL
- GX-M
- GX-U/GX-FU/GX-N
- GX**

**APPLICATIONS**

**Sensing screws on cassette**

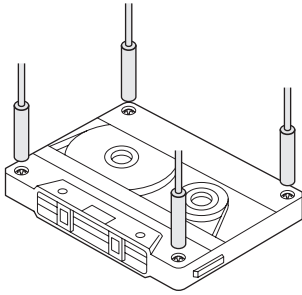

**Sensing the punch of a die**

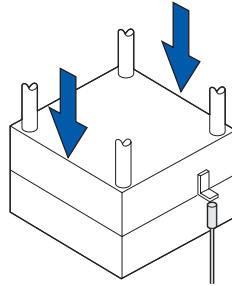

**Counting parts**

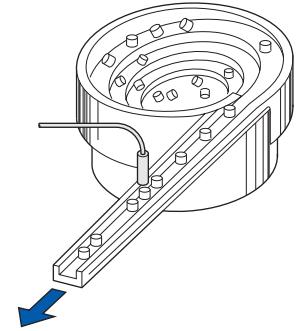

**ORDER GUIDE**

Type	Appearance (mm in)	Sensing range (Note)	Model No.	Supply voltage	Output	Output operation
Shielded type		Maximum operation distance 0.8 mm 0.031 in (0 to 0.6 mm 0 to 0.024 in) Stable sensing range	<b>GX-3S</b>	12 to 24 V DC ±10 %	NPN open-collector transistor	Normally open
			<b>GX-3SB</b>			Normally closed
	Robust enclosure type	0.8 mm 0.031 in (0 to 0.6 mm 0 to 0.024 in)	<b>GX-4S</b>			Normally open
			<b>GX-4SB</b>			Normally closed
		1 mm 0.039 in (0 to 0.8 mm 0 to 0.031 in)	<b>GX-5S</b>	10 to 30 V DC		Normally open
			<b>GX-5SB</b>	10 to 30 V DC		Normally closed
Threaded type		0.8 mm 0.031 in (0 to 0.6 mm 0 to 0.024 in)	<b>GX-5M</b>	12 to 24 V DC ±10 %	Normally open	
			<b>GX-5MB</b>		Normally closed	
		1 mm 0.039 in (0 to 0.8 mm 0 to 0.031 in)	<b>GX-8M</b>	10 to 30 V DC	Normally open	
			<b>GX-8MB</b>		Normally closed	
Non-shielded type		2 mm 0.079 in (0 to 1.6 mm 0 to 0.063 in)	<b>GX-8ML</b>		Normally open	
			<b>GX-8MLB</b>		Normally closed	

Note: The maximum operation distance stands for the maximum distance for which the sensor can detect the standard sensing object.  
 The stable sensing range stands for the sensing range for which the sensor can stably detect the standard sensing object even if there is an ambient temperature drift and/or supply voltage fluctuation.

- FIBER SENSORS
- LASER SENSORS
- PHOTO-ELECTRIC SENSORS
- MICRO PHOTO-ELECTRIC SENSORS
- AREA SENSORS
- LIGHT CURTAINS / SAFETY COMPONENTS
- PRESSURE / FLOW SENSORS
- INDUCTIVE PROXIMITY SENSORS
- PARTICULAR USE SENSORS
- SENSOR OPTIONS
- SIMPLE WIRE-SAVING UNITS
- WIRE-SAVING SYSTEMS
- MEASUREMENT SENSORS
- STATIC ELECTRICITY PREVENTION DEVICES
- LASER MARKERS
- PLC
- HUMAN MACHINE INTERFACES
- ENERGY CONSUMPTION VISUALIZATION COMPONENTS
- FA COMPONENTS
- MACHINE VISION SYSTEMS
- UV CURING SYSTEMS
- Selection Guide
- Amplifier Built-in
- Amplifier-separated
- GX-F/H**
- GXL**
- GL**
- GX-M**
- GX-U/GX-FU/GX-N
- GX**

FIBER SENSORS  
 LASER SENSORS  
 PHOTO-ELECTRIC SENSORS  
 MICRO PHOTO-ELECTRIC SENSORS  
 AREA SENSORS  
 LIGHT CURTAINS/SAFETY COMPONENTS  
 PRESSURE / FLOW SENSORS  
 INDUCTIVE PROXIMITY SENSORS  
 PARTICULAR USE SENSORS  
 SENSOR OPTIONS  
 SIMPLE WIRE-SAVING UNITS  
 WIRE-SAVING SYSTEMS  
 MEASURE-MENT SENSORS  
 STATIC ELECTRICITY PREVENTION DEVICES  
 LASER MARKERS  
 PLC  
 HUMAN MACHINE INTERFACES  
 ENERGY CONSUMPTION VISUALIZATION COMPONENTS  
 FA COMPONENTS  
 MACHINE VISION SYSTEMS  
 UV CURING SYSTEMS

## ORDER GUIDE

### Flexible cable type

Flexible cable type is also available for shielded type.  
 When ordering this type, suffix "-R" to the model No.  
 (e.g.) Flexible cable type of **GX-3S** is "**GX-3S-R**".

### 5 m 16.404 ft cable length type

5 m **16.404 ft** cable length type (standard: 3 m **9.843 ft**) is also available. (excluding **GX-4SB**)  
 When ordering this type, suffix "-C5" to the model No.  
 (e.g.) 5 m **16.404 ft** cable length type of **GX-3S** is "**GX-3S-C5**".

Refer to table below for 5 m **16.404 ft** cable length type of flexible cable type sensor.

• **Table of model Nos.**

Type		Standard	Flexible cable of 5 m 16.404 ft cable length type
Shielded type	Non-threaded type	<b>GX-3S</b>	<b>GX-3S-R-C5</b>
		<b>GX-3SB</b>	<b>GX-3SB-R-C5</b>
		<b>GX-4S</b>	<b>GX-4S-R-C5</b>
		<b>GX-4SB</b>	—————
		<b>GX-5S</b>	<b>GX-5S-R-C5</b>
	Threaded type	<b>GX-5SB</b>	—————
		<b>GX-5M</b>	<b>GX-5M-R-C5</b>
		<b>GX-5MB</b>	—————
		<b>GX-8M</b>	<b>GX-8M-R-C5</b>
		<b>GX-8MB</b>	<b>GX-8MB-R-C5</b>

### Accessories

- **MS-SS3** (Sensor mounting bracket for **GX-3S** type)
- **MS-SS3-2** (C bracket for **GX-3S** type)
- **MS-SS5** (Sensor mounting bracket for **GX-5S** type)

- **MS-SS3**
- **MS-SS5**

- **MS-SS3-2**

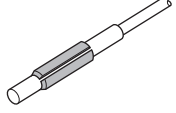
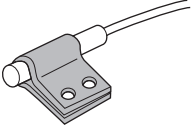

By using the C bracket, the applicable tightening force can be doubled.

Selection Guide  
 Amplifier Built-in  
 Amplifier-separated  
**GX-F/H**  
**GXL**  
**GL**  
**GX-M**  
 GX-U/GX-FU/  
 GX-N  
**GX**

**SPECIFICATIONS****Non-threaded type**

Type		Shielded type											
		Flexible cable				Flexible cable				Flexible cable			
Item	Model No.	GX-3S	GX-3SB	GX-3S-R	GX-3SB-R	GX-4S	GX-4SB	GX-4S-R	GX-4SB-R	GX-5S	GX-5SB	GX-5S-R	GX-5SB-R
Max. operation distance (Note 2)		0.8 mm <b>0.031 in</b> ±15 %								1 mm <b>0.039 in</b> ±15 %			
Stable sensing range (Note 2)		0 to 0.6 mm <b>0 to 0.024 in</b>								0 to 0.8 mm <b>0 to 0.031 in</b>			
Standard sensing object		Iron sheet 5 × 5 × t 1 mm <b>0.197 × 0.197 × t 0.039 in</b>								Iron sheet 6 × 6 × t 1 mm <b>0.236 × 0.236 × t 0.039 in</b>			
Hysteresis		15 % or less of operation distance (with standard sensing object)											
Repeatability		20 μm <b>0.787 mil</b> or less								8 μm <b>0.315 mil</b> or less			
Supply voltage		12 to 24 V DC ±10 % Ripple P-P 10 % or less								10 to 30 V DC Ripple P-P 10 % or less			
Current consumption		15 mA or less											
Output		NPN open-collector transistor <ul style="list-style-type: none"> <li>• Maximum sink current: 50 mA</li> <li>• Applied voltage: 30 V DC or less (between output and 0 V)</li> <li>• Residual voltage: 0.4 V or less (at 50 mA sink current)</li> </ul>								NPN open-collector transistor <ul style="list-style-type: none"> <li>• Maximum sink current: 200 mA (Note 3)</li> <li>• Applied voltage: 30 V DC or less (between output and 0 V)</li> <li>• Residual voltage: 1.5 V or less (at 200 mA sink current)</li> <li>0.4 V or less (at 50 mA sink current)</li> </ul>			
	Utilization category	DC-12 or DC-13											
	Output operation	Normally open	Normally closed	Normally open	Normally closed	Normally open	Normally closed	Normally open	Normally closed	Normally open	Normally closed	Normally open	Normally closed
	Short-circuit protection	—								Incorporated			
Max. response frequency		1 kHz								1.5 kHz			
Operation indicator		Red LED (lights up when the output is ON)											
Environmental resistance	Pollution degree	3 (Industrial environment)											
	Protection	IP67 (IEC)											
	Ambient temperature	-25 to +70 °C <b>-13 to +158 °F</b> , Storage: -25 to +80 °C <b>-13 to +176 °F</b>											
	Ambient humidity	35 to 95 % RH, Storage: 35 to 95 % RH								35 to 85 % RH, Storage: 35 to 95 % RH			
	EMC	EN 60947-5-2											
	Voltage withstandability	500 V AC for one min. between all supply terminals connected together and enclosure											
	Insulation resistance	5 MΩ, or more, with 250 V DC megger between all supply terminals connected together and enclosure								50 MΩ, or more, with 500 V DC megger between all supply terminals connected together and enclosure			
	Vibration resistance	10 to 55 Hz frequency, 1.5 mm <b>0.059 in</b> amplitude in X, Y and Z directions for two hours each											
	Shock resistance	200 m/s <sup>2</sup> acceleration (20 G approx.) in X, Y and Z directions for ten times each								300 m/s <sup>2</sup> acceleration (30 G approx.) in X, Y and Z directions for ten times each			
Sensing range variation	Temperature characteristics	Over ambient temperature range -25 to +70 °C <b>-13 to +158 °F</b> : Within ±20 % of sensing range at +20 °C <b>+68 °F</b>								Over ambient temperature range -25 to +70 °C <b>-13 to +158 °F</b> : Within ±15 % of sensing range at +20 °C <b>+68 °F</b>			
	Voltage characteristics	Within ±2 % for ±10 % fluctuation of the supply voltage								Within ±2.5 % for ±15 % fluctuation of the supply voltage			
Material		Enclosure: Stainless steel (SUS304), Resin part: TPX								Enclosure: Brass (Nickel plated) Resin part: ABS			
Cable		0.08 mm <sup>2</sup> 3-core oil, heat and cold resistant cabtyre cable, 3 m <b>9.843 ft</b> long	0.1 mm <sup>2</sup> 3-core flexible, oil and heat resistant cabtyre cable, 3 m <b>9.843 ft</b> long	0.08 mm <sup>2</sup> 3-core oil, heat and cold resistant cabtyre cable, 3 m <b>9.843 ft</b> long	0.1 mm <sup>2</sup> 3-core flexible, oil and heat resistant cabtyre cable, 3 m <b>9.843 ft</b> long	0.08 mm <sup>2</sup> 3-core oil, heat and cold resistant cabtyre cable, 3 m <b>9.843 ft</b> long	0.1 mm <sup>2</sup> 3-core flexible, oil and heat resistant cabtyre cable, 3 m <b>9.843 ft</b> long	0.14 mm <sup>2</sup> 3-core oil, heat and cold resistant cabtyre cable, 3 m <b>9.843 ft</b> long	0.15 mm <sup>2</sup> 3-core flexible, oil and heat resistant cabtyre cable, 3 m <b>9.843 ft</b> long				
Cable extension		Extension up to total 100 m <b>328.084 ft</b> is possible with 0.3 mm <sup>2</sup> , or more, cable.											
Weight		Net weight: 30 g approx.								Net weight: 55 g approx.			
Accessories		<b>MS-SS3</b> (Sensor mounting bracket): 1 pc. <b>MS-SS3-2</b> (C bracket): 1 pc.								<b>MS-SS5</b> (Sensor mounting bracket): 1 pc.			

Notes: 1) Where measurement conditions have not been specified precisely, the conditions used were an ambient temperature of +23 °C **+73.4 °F**.

2) The maximum operation distance stands for the maximum distance for which the sensor can detect the standard sensing object.

The stable sensing range stands for the sensing range for which the sensor can stably detect the standard sensing object even if there is an ambient temperature drift and/or supply voltage fluctuation.

3) The maximum sink current varies depending on the ambient temperature. Refer to "**I/O CIRCUIT AND WIRING DIAGRAMS** (p.870)" for details.

FIBER  
SENSORSLASER  
SENSORSPHOTO-  
ELECTRIC  
SENSORSMICRO  
PHOTO-  
ELECTRIC  
SENSORSAREA  
SENSORSLIGHT  
CURTAINS /  
SAFETY  
COMPONENTSPRESSURE /  
FLOW  
SENSORSINDUCTIVE  
PROXIMITY  
SENSORSPARTICULAR  
USE  
SENSORSSENSOR  
OPTIONSSIMPLE  
WIRE-SAVING  
UNITSWIRE-SAVING  
SYSTEMSMEASURE-  
MENT  
SENSORSSTATIC  
ELECTRICITY  
PREVENTION  
DEVICESLASER  
MARKERS

PLC

HUMAN  
MACHINE  
INTERFACESENERGY  
CONSUMPTION  
VISUALIZATION  
COMPONENTSFA  
COMPONENTSMACHINE  
VISION  
SYSTEMSUV  
CURING  
SYSTEMSSelection  
GuideAmplifier  
Built-inAmplifier-  
separated**GX-F/H****GXL****GL****GX-M**GX-UGX-FU/  
GX-N**GX**

FIBER SENSORS  
LASER SENSORS  
PHOTO-ELECTRIC SENSORS  
MICRO PHOTO-ELECTRIC SENSORS  
AREA SENSORS  
LIGHT CURTAINS / SAFETY COMPONENTS  
PRESSURE / FLOW SENSORS  
INDUCTIVE PROXIMITY SENSORS  
PARTICULAR USE SENSORS  
SENSOR OPTIONS  
SIMPLE WIRE-SAVING UNITS  
WIRE-SAVING SYSTEMS  
MEASUREMENT SENSORS  
STATIC ELECTRICITY PREVENTION DEVICES  
LASER MARKERS  
PLC  
HUMAN MACHINE INTERFACES  
ENERGY CONSUMPTION VISUALIZATION COMPONENTS  
FA COMPONENTS  
MACHINE VISION SYSTEMS  
UV CURING SYSTEMS  
Selection Guide  
Amplifier Built-in  
Amplifier-separated  
GX-F/H  
GXL  
GL  
GX-M  
GX-U/GX-FU/  
GX-N  
GX

**SPECIFICATIONS**

**Threaded type**

Item	Type	Shielded type								Non-shielded type	
		Flexible cable				Flexible cable				GX-8ML	GX-8MLB
Model No.	GX-5M	GX-5MB	GX-5M-R	GX-5MB-R	GX-8M	GX-8MB	GX-8M-R	GX-8MB-R			
Max. operation distance (Note 2)		0.8 mm <b>0.031 in</b> ±15 %				1 mm <b>0.039 in</b> ±15 %				2 mm <b>0.079 in</b> ±15 %	
Stable sensing range (Note 2)		0 to 0.6 mm <b>0 to 0.024 in</b>				0 to 0.8 mm <b>0 to 0.031 in</b>				0 to 1.6 mm <b>0 to 0.063 in</b>	
Standard sensing object		Iron sheet 5 × 5 × t 1 mm <b>0.197 × 0.197 × t 0.039 in</b>				Iron sheet 8 × 8 × t 1 mm <b>0.315 × 0.315 × t 0.039 in</b>				Iron sheet 12 × 12 × t 1 mm <b>0.472 × 0.472 × t 0.039 in</b>	
Hysteresis		15 % or less of operation distance (with standard sensing object)				10 % or less of operation distance (with standard sensing object)					
Repeatability		20 μm <b>0.787 mil</b> or less				8 μm <b>0.315 mil</b> or less				40 μm <b>1.575 mil</b> or less	
Supply voltage		12 to 24 V DC ±10 % Ripple P-P 10 % or less				10 to 30 V DC Ripple P-P 10 % or less					
Current consumption						15 mA or less					
Output		NPN open-collector transistor • Maximum sink current: 50 mA • Applied voltage: 30 V DC or less (between output and 0V) • Residual voltage: 0.4 V or less (at 50 mA sink current)				NPN open-collector transistor • Maximum sink current: 200 mA (Note 3) • Applied voltage: 30 V DC or less (between output and 0 V) • Residual voltage: 1.5 V or less (at 200 mA sink current) 0.4 V or less (at 50 mA sink current)					
	Utilization category	DC-12 or DC-13									
	Output operation	Normally open	Normally closed	Normally open	Normally closed	Normally open	Normally closed	Normally open	Normally closed	Normally open	Normally closed
Short-circuit protection					Incorporated						
Max. response frequency		1 kHz				500 Hz					
Operation indicator		Red LED (lights up when the output is ON)									
Environmental resistance	Pollution degree	3 (Industrial environment)									
	Protection	IP67 (IEC)									
	Ambient temperature	- 25 to +70 °C <b>-13 to +158 °F</b> , Storage: - 25 to +80 °C <b>- 13 to +176 °F</b>									
	Ambient humidity	35 to 95 % RH, Storage: 35 to 95 % RH				35 to 85 % RH, Storage: 35 to 95 % RH					
	EMC	EN 60947-5-2									
	Voltage withstandability	500 V AC for one min. between all supply terminals connected together and enclosure									
	Insulation resistance	5 MΩ, or more, with 250 V DC megger between all supply terminals connected together and enclosure				50 MΩ, or more, with 500 V DC megger between all supply terminals connected together and enclosure					
	Vibration resistance	10 to 55 Hz frequency, 1.5 mm <b>0.059 in</b> amplitude in X, Y and Z directions for two hours each									
Shock resistance	200 m/s <sup>2</sup> acceleration (20 G approx.) in X, Y and Z directions for ten times each				300 m/s <sup>2</sup> acceleration (30 G approx.) in X, Y and Z directions for ten times each				300 m/s <sup>2</sup> acceleration (30 G approx.) in X, Y and Z directions for three times each		
Sensing range variation	Temperature characteristics	Over ambient temperature range - 25 to +70 °C <b>-13 to +158 °F</b> : Within ±20 % of sensing range at +20 °C <b>+68 °F</b>				Over ambient temperature range -25 to +70 °C <b>-13 to +158 °F</b> : Within $\pm\frac{15}{-10}$ % of sensing range at +20 °C <b>+68 °F</b>					
	Voltage characteristics	Within ±2 % for ±10 % fluctuation of the supply voltage				Within ±2.5 % for ±15 % fluctuation of the supply voltage					
Material		Enclosure: Brass (Nickel plated) Resin part: TPX				Enclosure: Brass (Nickel plated) Resin part: ABS					
Cable		0.08 mm <sup>2</sup> 3-core oil, heat and cold resistant cabtyre cable, 3 m <b>9.843 ft</b> long		0.1 mm <sup>2</sup> 3-core flexible, oil and heat resistant cabtyre cable, 3 m <b>9.843 ft</b> long		0.14 mm <sup>2</sup> 3-core oil, heat and cold resistant cabtyre cable, 3 m <b>9.843 ft</b> long		0.15 mm <sup>2</sup> 3-core flexible, oil and heat resistant cabtyre cable, 3 m <b>9.843 ft</b> long		0.14 mm <sup>2</sup> 3-core, oil, heat and cold resistant cabtyre cable, 3 m <b>9.843 ft</b> long	
Cable extension		Extension up to total 100 m <b>328.084 ft</b> is possible with 0.3 mm <sup>2</sup> , or more, cable.								Extension up to total 100 m <b>328.084 ft</b> is possible with 0.14 mm <sup>2</sup> , or more, cable.	
Weight (Note 4)		Net weight: 30 g approx.				Net weight: 60 g approx.					
Accessories		Nut: 2 pcs. Toothed lock washer: 1 pc.		Nut: 2 pcs. Toothed lock washer: 2 pcs.		Nut: 2 pcs. Toothed lock washer: 1 pc.		Nut: 2 pcs. Toothed lock washer: 2 pcs.		Nut: 2 pcs. Toothed lock washer: 1 pc.	

Notes: 1) Where measurement conditions have not been specified precisely, the conditions used were an ambient temperature of +23 °C **+73.4 °F**.  
 2) The maximum operation distance stands for the maximum distance for which the sensor can detect the standard sensing object.  
 The stable sensing range stands for the sensing range for which the sensor can stably detect the standard sensing object even if there is an ambient temperature drift and/or supply voltage fluctuation.  
 3) The maximum sink current varies depending on the ambient temperature. Refer to "I/O CIRCUIT AND WIRING DIAGRAMS (p.870)" for details.  
 4) The given weight of the threaded type includes the weight of two nuts and one toothed lock washer.

**I/O CIRCUIT AND WIRING DIAGRAMS**

**GX-5S □ GX-8M □ GX-8ML □**

**I/O circuit diagram**

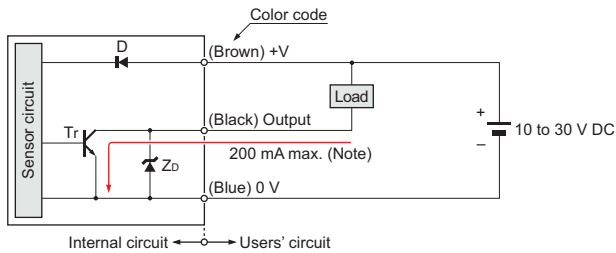

Symbols ... D : Reverse supply polarity protection diode  
 Zd: Surge absorption zener diode  
 Tr : NPN output transistor

- If a capacitor of 1  $\mu\text{F}$  or more is connected between 0 V and output or between +V and output, connect a 100  $\Omega$  resistor in series as shown below.

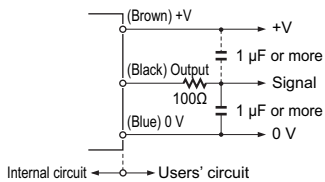

Without the resistor, the short-circuit protection is activated by the charge or discharge current of the capacitor, so that it results in delaying the response whenever the sensor switches. The connected resistor solves this problem.

**Wiring diagram**

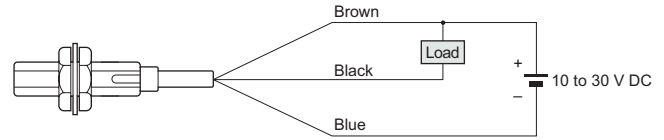

Note: The maximum sink current varies depending on the ambient temperature.

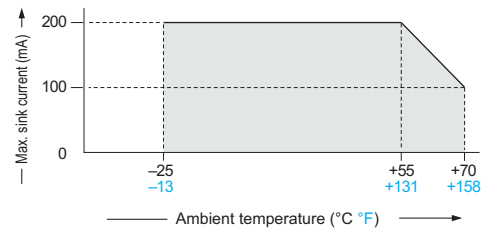

**GX-3S □ GX-4S □ GX-5M □**

**I/O circuit diagram**

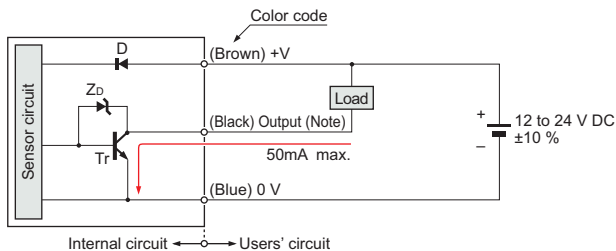

Note: **GX-3S**, **GX-4S** and **GX-5M** do not incorporate a short-circuit protection circuit at the output. Do not connect them directly to a power supply or a capacitive load.

Symbols ... D : Reverse supply polarity protection diode  
 Zd: Surge absorption zener diode  
 Tr : NPN output transistor

**Wiring diagram**

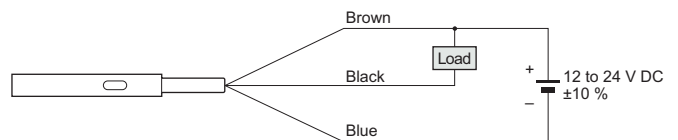

- FIBER SENSORS
- LASER SENSORS
- PHOTO-ELECTRIC SENSORS
- MICRO PHOTO-ELECTRIC SENSORS
- AREA SENSORS
- LIGHT CURTAINS / SAFETY COMPONENTS
- PRESSURE / FLOW SENSORS
- INDUCTIVE PROXIMITY SENSORS**
- PARTICULAR USE SENSORS
- SENSOR OPTIONS
- WIRE-SAVING UNITS
- WIRE-SAVING SYSTEMS
- MEASUREMENT SENSORS
- STATIC ELECTRICITY PREVENTION DEVICES
- LASER MARKERS
- PLC
- HUMAN MACHINE INTERFACES
- ENERGY CONSUMPTION VISUALIZATION COMPONENTS
- FA COMPONENTS
- MACHINE VISION SYSTEMS
- UV CURING SYSTEMS
- Selection Guide
- Amplifier Built-in
- Amplifier-separated
- GX-F/H**
- GXL**
- GL**
- GX-M**
- GX-U/GX-FU/GX-N
- GX**

- FIBER SENSORS
- LASER SENSORS
- PHOTO-ELECTRIC SENSORS
- MICRO PHOTO-ELECTRIC SENSORS
- AREA SENSORS
- LIGHT CURTAINS/SAFETY COMPONENTS
- PRESSURE / FLOW SENSORS
- INDUCTIVE PROXIMITY SENSORS
- PARTICULAR USE SENSORS
- SENSOR OPTIONS
- SIMPLE WIRE-SAVING UNITS
- WIRE-SAVING SYSTEMS
- MEASUREMENT SENSORS
- STATIC ELECTRICITY PREVENTION DEVICES
- LASER MARKERS
- PLC
- HUMAN MACHINE INTERFACES
- ENERGY CONSUMPTION VISUALIZATION COMPONENTS
- FA COMPONENTS
- MACHINE VISION SYSTEMS
- UV CURING SYSTEMS
- Selection Guide
- Amplifier Built-in
- Amplifier-separated
- GX-F/H
- GXL
- GL
- GX-M
- GX-U/GX-FU/GX-N
- GX**

## SENSING CHARACTERISTICS (TYPICAL)

### GX-3S □ GX-4S □ GX-5M □

**Sensing field**

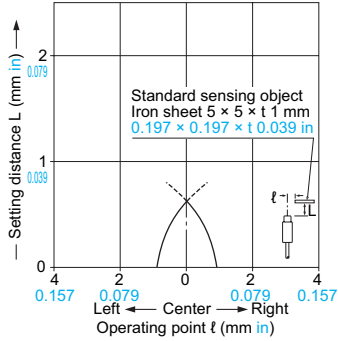

**Correlation between sensing object size and sensing range**

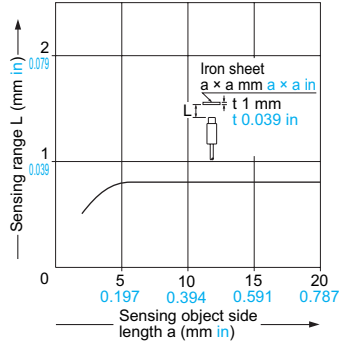

As the sensing object size becomes smaller than the standard size (iron sheet  $5 \times 5 \times t 1 \text{ mm}$   $0.197 \times 0.197 \times t 0.039 \text{ in}$ ), the sensing range shortens as shown in the left figure.

### GX-5S □

**Sensing field**

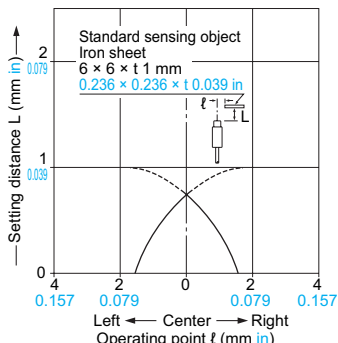

**Correlation between sensing object size and sensing range**

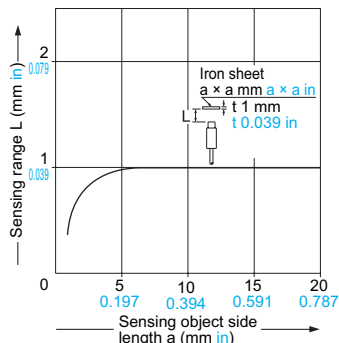

As the sensing object size becomes smaller than the standard size (iron sheet  $6 \times 6 \times t 1 \text{ mm}$   $0.236 \times 0.236 \times t 0.039 \text{ in}$ ), the sensing range shortens as shown in the left figure.

### GX-8M □

**Sensing field**

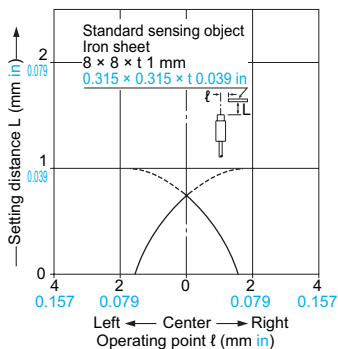

**Correlation between sensing object size and sensing range**

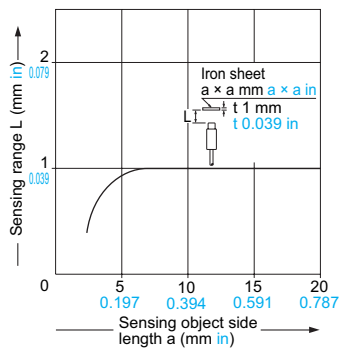

As the sensing object size becomes smaller than the standard size (iron sheet  $8 \times 8 \times t 1 \text{ mm}$   $0.315 \times 0.315 \times t 0.039 \text{ in}$ ), the sensing range shortens as shown in the left figure.

### GX-8ML □

**Sensing field**

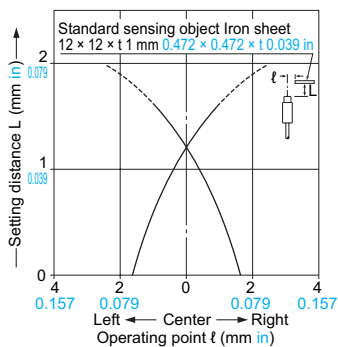

**Correlation between sensing object size and sensing range**

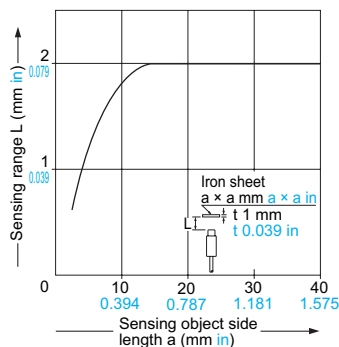

As the sensing object size becomes smaller than the standard size (iron sheet  $12 \times 12 \times t 1 \text{ mm}$   $0.472 \times 0.472 \times t 0.039 \text{ in}$ ), the sensing range shortens as shown in the left figure.



**PRECAUTIONS FOR PROPER USE**

Refer to p.1485~ for general precautions.



- Never use this product as a sensing device for personnel protection.
- In case of using sensing devices for personnel protection, use products which meet laws and standards, such as OSHA, ANSI or IEC etc., for personnel protection applicable in each region or country.

**Mounting**

- The tightening torque should be as given below.

**Mounting with set screw**

**<Shielded of threaded type>**

- Tighten the set screw on the flat surface of the sensor without applying excessive force. Make sure to use a set screw with a cup-point end.

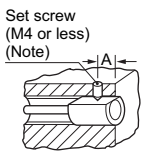

Note: To fasten **GX-5M□**, use a M3 or less set screw.

Model No.	Set screw tightening position A (mm in)	Tightening torque
<b>GX-5M□</b>	5 to 10 <b>0.197 to 0.394</b>	0.29 N·m
<b>GX-8M□</b>	8 to 22 <b>0.315 to 0.866</b>	0.29 N·m

**<Non-threaded type and non-shielded of threaded type>**

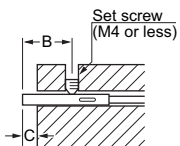

Model No.	B (mm in)	C (mm in)	Tightening torque
<b>GX-3S□</b>	5 to 10 <b>0.197 to 0.394</b>	3 <b>0.118</b>	0.29 N·m
			0.58 N·m
<b>GX-4S□</b>	5 to 10 <b>0.197 to 0.394</b>	3 <b>0.118</b>	0.58 N·m
<b>GX-5S□</b>	8 to 20 <b>0.315 to 0.787</b>	5 <b>0.197</b>	0.29 N·m
<b>GX-8ML□</b>	13 to 22 <b>0.517 to 0.866</b>	10 <b>0.394</b>	0.29 N·m

Note: The protrusion should be kept C (mm in) or more to avoid reduction of sensing range.

- To fasten **GX-3S□** and **GX-4S□**, use a M3 or less set screw and tighten it from a direction perpendicular to the operation indicator.

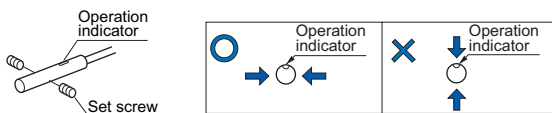

- When using the C bracket, place it on the sensor at a distance of 3 mm **0.118 in** or more from the sensor end.

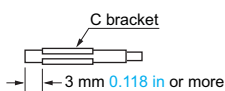

- To fasten the non-shielded threaded type, tighten the set screw on the flat surface of the sensor.

**Mounting with nut**

- Note that the maximum tightening torque differs according to the location of the nuts.

**<Shielded of threaded type>    <Non-shielded of threaded type>**

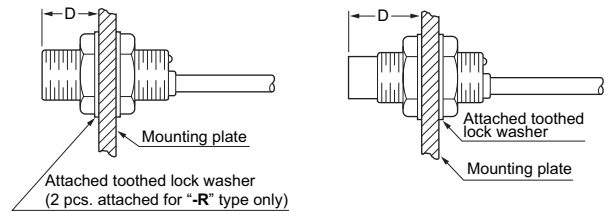

Model No.	D (mm in)	Tightening torque
<b>GX-5M□</b>	2 to 3 <b>0.079 to 0.118</b>	0.49 N·m
	3 <b>0.118</b> or more	1.47 N·m
<b>GX-8M□</b>	3 to 11 <b>0.118 to 0.433</b>	1.47 N·m
	11 <b>0.433</b> or more	3.43 N·m
<b>GX-8ML□</b>	9 to 11 <b>0.345 to 0.433</b>	0.98 N·m
	11 <b>0.433</b> or more	3.43 N·m

Note: Mount such that the nuts do not protrude from the threaded portion.

- The root truncation of the threads with **GX-8M□** and **GX-8ML□** is shallow owing to strengthening of the sensors against tightening. When tapping holes on equipment to fix the sensors, the prepared holes must be  $\varnothing 7.2$  mm  **$\varnothing 0.283$  in** or more.

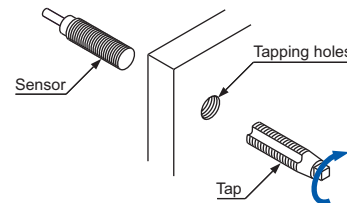

FIBER SENSORS  
LASER SENSORS  
PHOTO-ELECTRIC SENSORS  
MICRO PHOTO-ELECTRIC SENSORS  
AREA SENSORS  
LIGHT CURTAINS / SAFETY COMPONENTS  
PRESSURE / FLOW SENSORS  
INDUCTIVE PROXIMITY SENSORS  
PARTICULAR USE SENSORS  
SENSOR OPTIONS  
SIMPLE WIRE-SAVING UNITS  
WIRE-SAVING SYSTEMS  
MEASUREMENT SENSORS  
STATIC ELECTRICITY PREVENTION DEVICES  
LASER MARKERS  
PLC  
HUMAN MACHINE INTERFACES  
ENERGY CONSUMPTION VISUALIZATION COMPONENTS  
FA COMPONENTS  
MACHINE VISION SYSTEMS  
UV CURING SYSTEMS  
Selection Guide  
Amplifier Built-in  
Amplifier-separated  
**GX-F/H**  
**GXL**  
**GL**  
**GX-M**  
GX-U/GX-FU/  
GX-N  
**GX**

- FIBER SENSORS
- LASER SENSORS
- PHOTO-ELECTRIC SENSORS
- MICRO PHOTO-ELECTRIC SENSORS
- AREA SENSORS
- LIGHT CURTAINS/SAFETY COMPONENTS
- PRESSURE / FLOW SENSORS
- INDUCTIVE PROXIMITY SENSORS**
- PARTICULAR USE SENSORS
- SENSOR OPTIONS
- SIMPLE WIRE-SAVING UNITS
- WIRE-SAVING SYSTEMS
- MEASUREMENT SENSORS
- STATIC ELECTRICITY PREVENTION DEVICES
- LASER MARKERS
- PLC
- HUMAN MACHINE INTERFACES
- ENERGY CONSUMPTION VISUALIZATION COMPONENTS
- FA COMPONENTS
- MACHINE VISION SYSTEMS
- UV CURING SYSTEMS
- Selection Guide
- Amplifier Built-in
- Amplifier-separated
- GX-F/H
- GXL
- GL
- GX-M
- GX-U/GX-FU/GX-N
- GX**

## PRECAUTIONS FOR PROPER USE

Refer to p.1485~ for general precautions.

### Distance from surrounding metal

- As metal around the sensor may affect the sensing performance, pay attention to the following points.

#### Influence of surrounding metal

- The surrounding metal will affect the sensing performance. Keep the minimum distance specified in the table below.

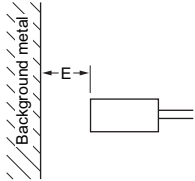

Model No.	E (mm in)
<b>GX-3S</b> □	3 <b>0.118</b>
<b>GX-4S</b> □	3 <b>0.118</b>
<b>GX-5S</b> □	4 <b>0.157</b>
<b>GX-5M</b> □	3 <b>0.118</b>
<b>GX-8M</b> □	4 <b>0.157</b>
<b>GX-8ML</b> □	8 <b>0.315</b>

#### Embedding of the sensor in metal

- Sensing range may decrease if the sensor is completely embedded in metal. Especially for the non-threaded type and the non-shielded type, keep the minimum distance specified in the table below.

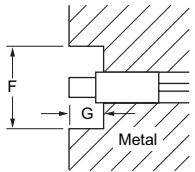

Model No.	F (mm in)	G (mm in)
<b>GX-3S</b> □	∅12 <b>∅0.472</b>	3 <b>0.118</b>
<b>GX-4S</b> □	∅12 <b>∅0.472</b>	3 <b>0.118</b>
<b>GX-5S</b> □	∅15.4 <b>∅0.606</b>	5 <b>0.197</b>
<b>GX-8ML</b> □	∅30 <b>∅1.181</b>	10 <b>0.394</b>

### Mutual interference

- When two or more sensors are installed in parallel or face to face, keep the minimum separation distance specified below to avoid mutual interference.

#### Face to face mounting

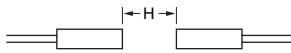

Model No.	H (mm in)	J (mm in)
<b>GX-3S</b> □	16 <b>0.630</b>	16 <b>0.630</b>
<b>GX-4S</b> □	16 <b>0.630</b>	16 <b>0.630</b>
<b>GX-5S</b> □	20 <b>0.787</b>	15 <b>0.591</b>
<b>GX-5M</b> □	10 <b>0.394</b>	10 <b>0.394</b>
<b>GX-8M</b> □	20 <b>0.787</b>	15 <b>0.591</b>
<b>GX-8ML</b> □	50 <b>1.969</b>	30 <b>1.181</b>

#### Parallel mounting



### Sensing range

- The sensing range is specified for the standard sensing object. With a non-ferrous metal, the sensing range is obtained by multiplying with the correction coefficient specified below. Further, the sensing range also changes if the sensing object is smaller than the standard sensing object or if the sensing object is plated.

#### Correction coefficient

Model No.	Correction Coefficient		
	<b>GX-3S</b> □ <b>GX-4S</b> □	<b>GX-5M</b> □	<b>GX-5S</b> □ <b>GX-8M</b> □ <b>GX-8ML</b> □
Metal			
Iron	1	1	1
Stainless steel (SUS304)	0.65 approx.	0.83 approx.	0.7 approx.
Brass	0.36 approx.	0.61 approx.	0.4 approx.
Aluminum	0.30 approx.	0.58 approx.	0.35 approx.

### Others

- Do not use during the initial transient time (10 ms) after the power supply is switched on.
- Make sure that stress by forcible bend or pulling is not applied directly to the sensor cable joint.
- GX-3S**□, **GX-4S**□ and **GX-5M**□ do not incorporate a short-circuit protection circuit at the output. Do not connect them directly to a power supply or a capacitive load.

**DIMENSIONS (Unit: mm in)**

The CAD data in the dimensions can be downloaded from our website.

**GX-3S□** Sensor

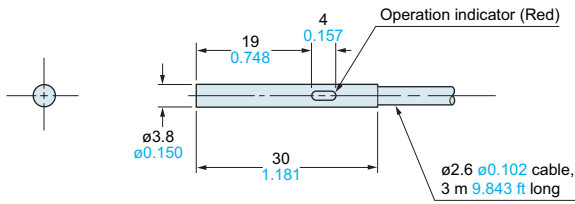

**GX-4S□** Sensor

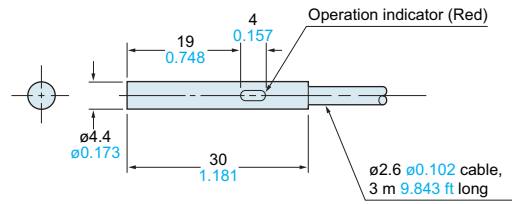

**GX-5S□** Sensor

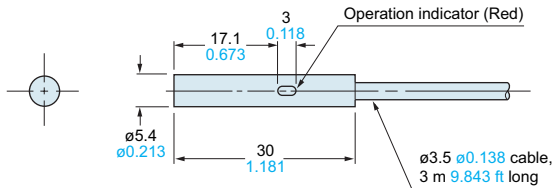

**GX-5M□** Sensor

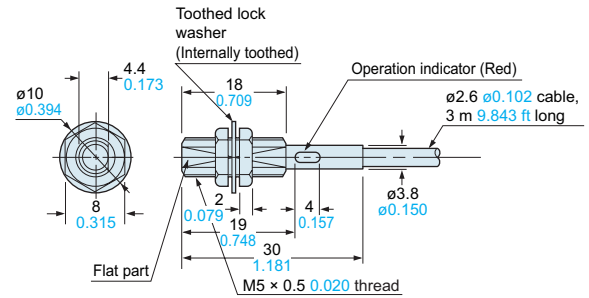

**GX-8M□** Sensor

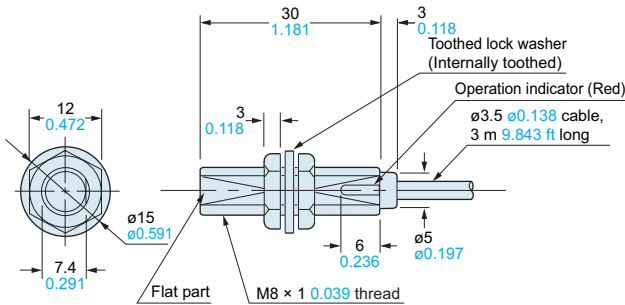

**GX-8ML□** Sensor

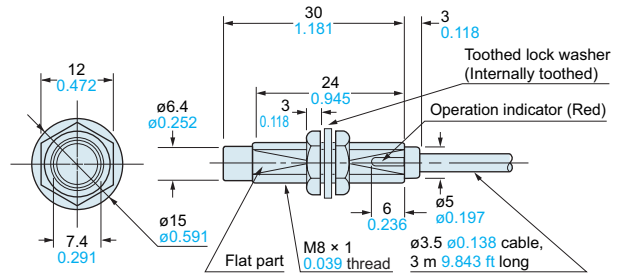

**MS-SS3-2** C bracket for GX-3S□ (Accessory for GX-3S□)

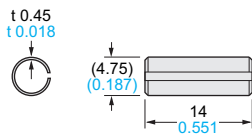

Note: By using the C bracket, the applicable tightening force can be doubled.

**MS-SS3** Sensor mounting bracket for GX-3S□ (Accessory for GX-3S□)  
**MS-SS5** Sensor mounting bracket for GX-5S□ (Accessory for GX-5S□)

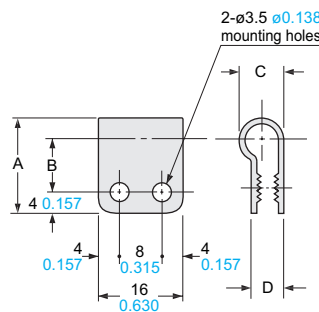

Model No.	MS-SS3	MS-SS5
Symbol		
A	16 0.630	18 0.709
B	9 0.354	10 0.394
C	6.3 0.248	8.3 0.327
D	4.9 0.193	6.1 0.240
Applicable model No.	GX-3S□	GX-5S□

Material: Nylon 66

FIBER SENSORS

LASER SENSORS

PHOTO-ELECTRIC SENSORS

MICRO PHOTO-ELECTRIC SENSORS

AREA SENSORS

LIGHT CURTAINS / SAFETY COMPONENTS

PRESSURE / FLOW SENSORS

INDUCTIVE PROXIMITY SENSORS

PARTICULAR USE SENSORS

SENSOR OPTIONS

SIMPLE WIRE-SAVING UNITS

WIRE-SAVING SYSTEMS

MEASUREMENT SENSORS

STATIC ELECTRICITY PREVENTION DEVICES

LASER MARKERS

PLC

HUMAN MACHINE INTERFACES

ENERGY CONSUMPTION VISUALIZATION COMPONENTS

FA COMPONENTS

MACHINE VISION SYSTEMS

UV CURING SYSTEMS

Selection Guide

Amplifier Built-in

Amplifier-separated

GX-F/H

GXL

GL

GX-M

GX-U/GX-FU/GX-N

**GX**