



Chipsmall Limited consists of a professional team with an average of over 10 year of expertise in the distribution of electronic components. Based in Hongkong, we have already established firm and mutual-benefit business relationships with customers from,Europe,America and south Asia,supplying obsolete and hard-to-find components to meet their specific needs.

With the principle of “Quality Parts,Customers Priority,Honest Operation,and Considerate Service”,our business mainly focus on the distribution of electronic components. Line cards we deal with include Microchip,ALPS,ROHM,Xilinx,Pulse,ON,Everlight and Freescale. Main products comprise IC,Modules,Potentiometer,IC Socket,Relay,Connector.Our parts cover such applications as commercial,industrial, and automotives areas.

We are looking forward to setting up business relationship with you and hope to provide you with the best service and solution. Let us make a better world for our industry!



Contact us

Tel: +86-755-8981 8866 Fax: +86-755-8427 6832

Email & Skype: info@chipsmall.com Web: www.chipsmall.com

Address: A1208, Overseas Decoration Building, #122 Zhenhua RD., Futian, Shenzhen, China



HRS H.FL SERIES

The world's smallest low-profile coaxial connectors H.FL Coaxial Connectors

■ OUTLINE

The H.FL series of coaxial connectors consists of the world's smallest surface-mount low profile coaxial connectors.

The H.FL connectors have a lower profile, with a mounted height of approximately 30% that of our S.FL2 connectors. They occupy 20% less board space, allowing higher density internal wiring.

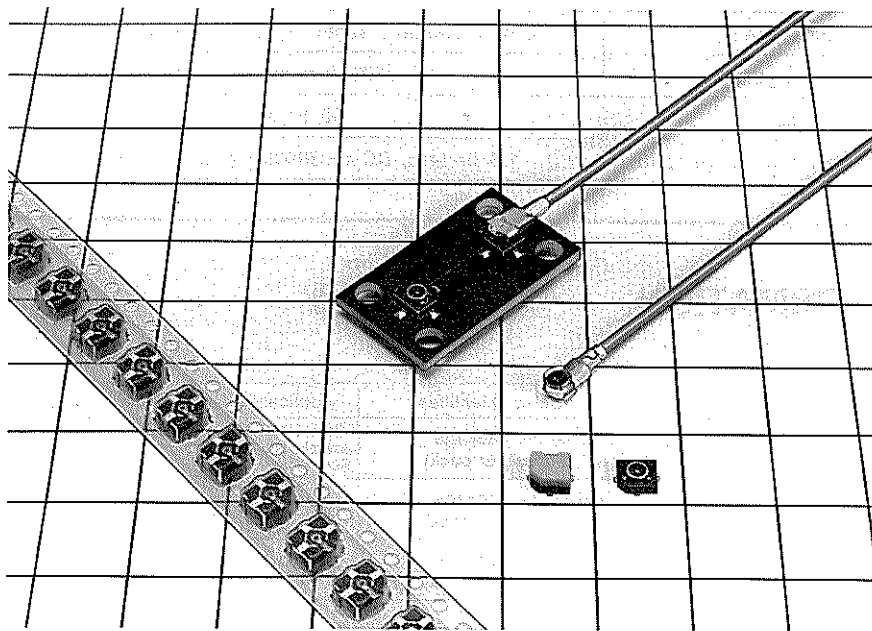

■ FEATURES

- (1) Height off printed circuit board of 3mm when connected (lowest in the world).
- (2) High frequency response of V.S.W.R 1.3 or less from D.C., A.C.1 to 3000 MHz.
- (3) Compressed wire system used on the cable side connector for both the center and exterior, providing stable connection quality. For the external conductor compression part, the shielded wire is compressed between metal, providing stability with respect to fluctuations in heat.
- (4) Wiring is possible with ultra-thin fluoropolymer cables with an external diameter of $\phi 1.48$, making high density internal wiring possible.
Compatible with the Junkosha DFS111-UL1979, the Hitachi CO-6F and FH-SB cables, as well as other cables in the future.
- (5) The connector can be easily removed with an extraction jig.
- (6) Emboss taping makes automatic mounting possible. In addition, connectors with caps are available for use with all types of mounters.
- (7) Connection can be easily verified. Despite the ultra small size, a locking feeling is provided making it possible to check that the connector is securely connected.
- (8) The connectors are equipped with an scoop-proof mechanism protecting against mis-insertion.
- (9) A cut is provided on the circuit board side connector, making it simple to check the direction after mounting.

■ APPLICATIONS

Portable telephones, cellular telephones, wireless communications devices, electronic measuring equipment, GPS, etc.

■ MATERIALS and TREATMENT

Part name	Material	Treatment
Shell	Phosphor bronze	Silver plating
Insulator	PBT plastic (plug side) Liquid crystal polymer (receptacle side)	Black Black
Male center contact	Bronze	Gold plating
Female center contact	Phosphor bronze	Gold plating

■ PERFORMANCE

Item	Rated value
Characteristic impedance	50 Ω
Insulation resistance	500M Ω or greater at DC 250V
Contact resistance	20m Ω (center), 10m Ω (exterior) at DC 10mA
Dielectric strength	AC 300V (r.m.s), 1 minute
Contact service life	50 times
Voltage standing wave ratio	1.3 or less, DC to 3000MHz (target value)

■ PRODUCT INFORMATION

▲ L-shaped plugs

Item	HRS No.	Model No.	Sales Quantities	Applicable cable	A Dimension	B Dimension
Right-angle plug shell	CL331-0503-4-01	H.FL-LP-DFS111(01)	Sold by the package (100 pieces per pack)	Hitachi CO-6F and FH-SB Junkosha DFS111-UL1979 Sumitomo 0.8DS-PBE	10.4	(6.95)
	CL331-0504-7-01	H.FL-LP-A32 (01)	Sold by the package (100 pieces per pack)	Junkosha A(2BO733)	10.8	(7.35)
	CL331-0506-2	H.FL-LP-1.25S(01)	Sold by the package (100 pieces per pack)	Hitachi 1-25C-6FFH	10.4	(6.95)
Female contact	CL331-0511-2	H.FL-LP Female contacts	Sold by the reel (10,000 contacts per reel)	Common cable is Used as above		

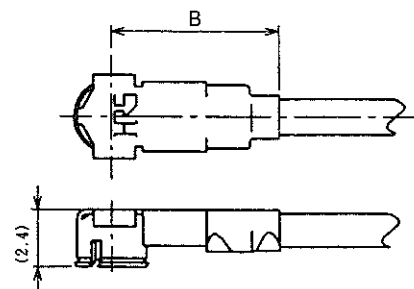
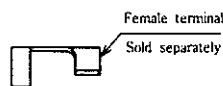
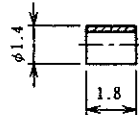
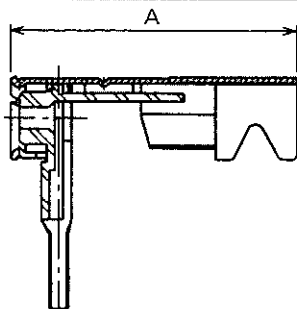
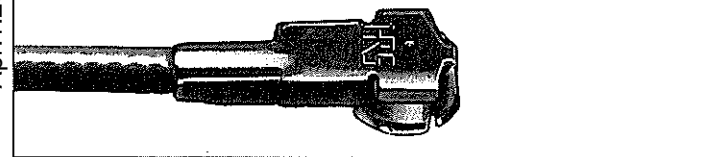

View after connected to cable

Note 1: Sales quantities of the H.FL-LP-DFS111(01) H.FL-LP-A32(01) are in units of 1 package (containing 100 pieces).
Also note that the H.FL-LP female contacts are sold in units of 1 reel (containing 10,000 pieces).

Note 2: The female contacts are sold as separate items.

▲ Receptacles

HRS No.	Model No.	Sales Quantities
CL331-0521-6-01	H.FL-R-SMT (01)	Sold by the package (100 pieces per pack)
CL331-0521-6-10	H.FL-R-SMT (10)	Sold by the reel (2,500 pieces per reel)

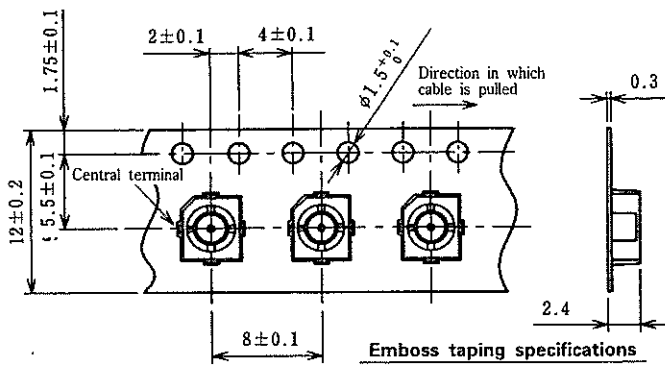
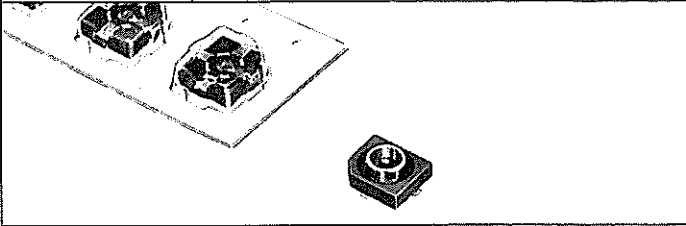

- Note 1:** Sales quantities of the H.FL-R-SMT(01) are in units of 1 package (containing 100 pieces). Also note that the H.FL-R-SMT(10) are sold in units of 1 reel (containing 2,500 pieces).
- Note 2:** These products may not be mountable with certain mounters.
- Note 3:** Allowable mold plastic on central terminal.

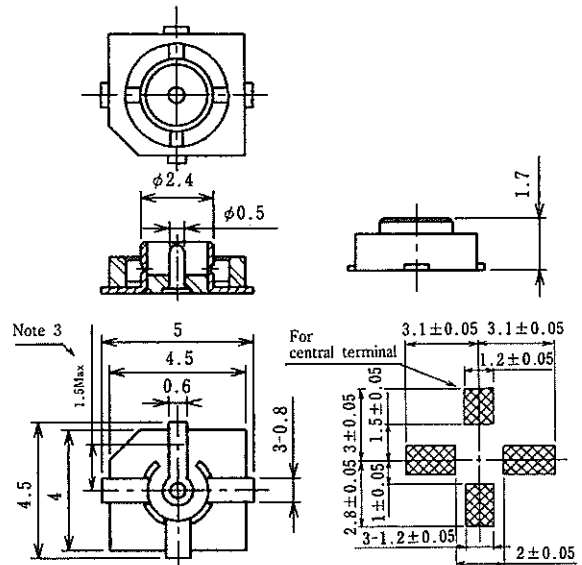

▲ Receptacles (with caps)

HRS No.	Model No.
CL331-0522-9-10	H.FL-R-SMT (C) (10)

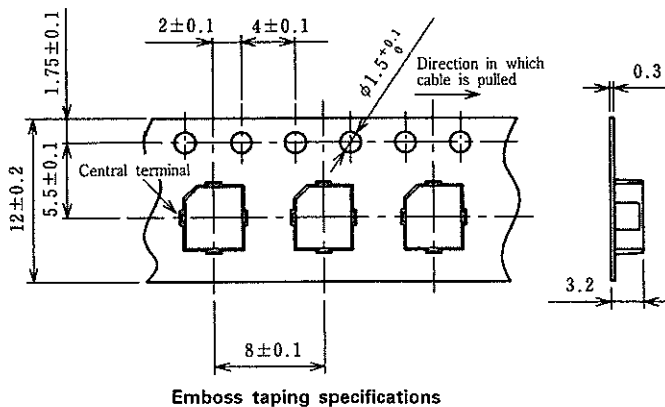
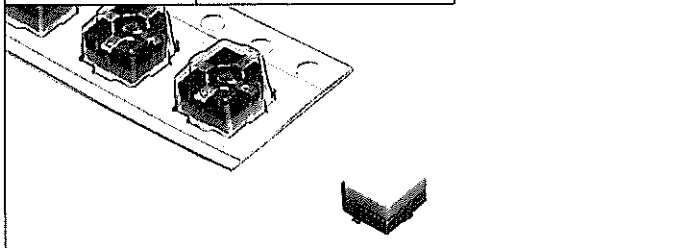

- Note 1:** These receptacles are sold in minimum units of 1 reel (2500 receptacles).
- Note 2:** These products include caps so that they can be mounted with any mounters. They cannot be inserted as such. Remove the cap after reflow.
- Note 3:** Allowable mold plastic on central terminal.

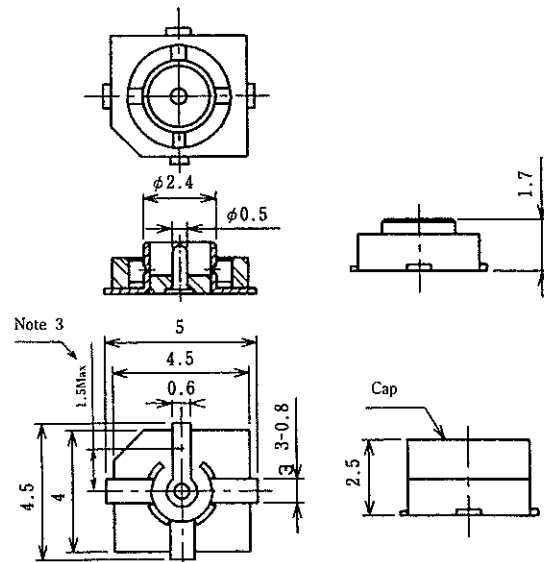

▲ Converter Adapters

HRS No.	Part No.
CL311-0232-4-40	HRMP-H.FLJ(40)

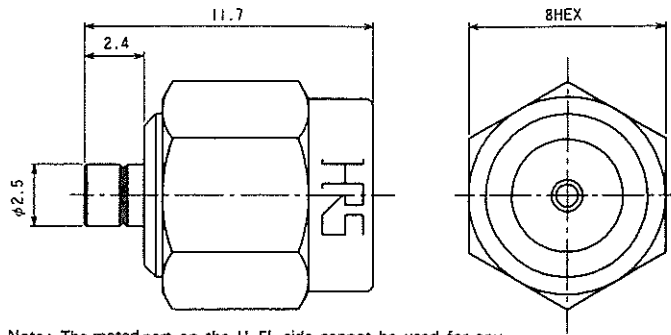
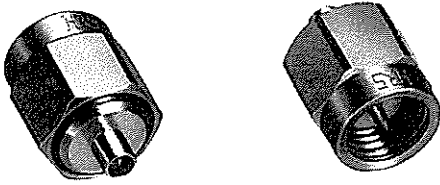

Note: The mated part on the H.FL side cannot be used for any purpose other than performance measurement because there is no lock mechanism.

HRS No.	Part No.
CL311-0264-0-40	HRMJ-H.FLP-3(40)

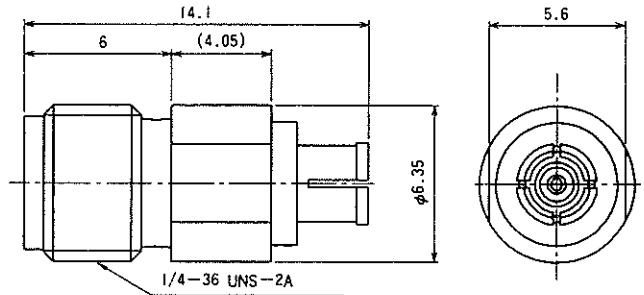
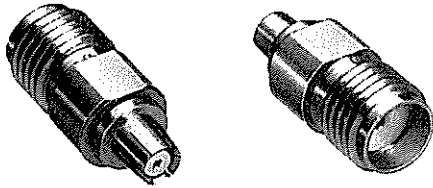

Note: The mated part on the H.FL side cannot be used for any purpose other than performance measurement because there is no lock mechanism.

▲ Attachments

HRS. No.	Part Number
CL331-0516-6	H.FL-R-1

For Inspection

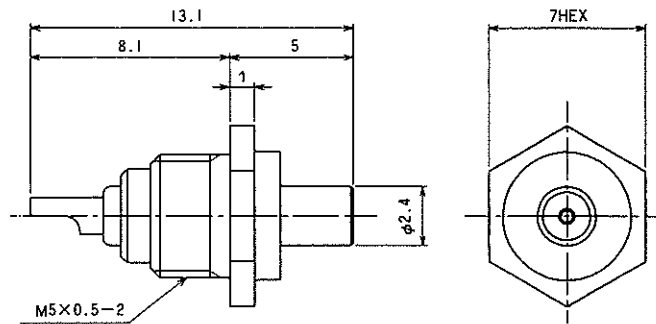
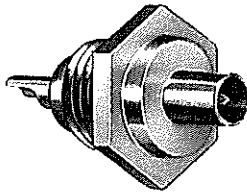

Note: This receptacle is used to inspect the conductivity and withstand voltage of harnesses.

HRS. No.	Part Number
CL331-0551-7	H.FL-LP-N

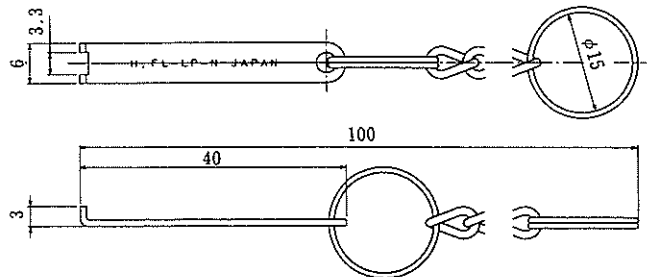

Note: This jig can be used in narrow spaces because it can be inserted from the cable side.

HARNESSED MODELS

For harnessed H.FL series, follow the dimensions specified below.

Single-connector harness

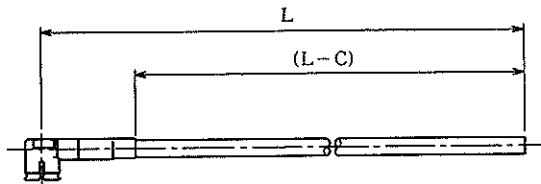

Double-connector harness

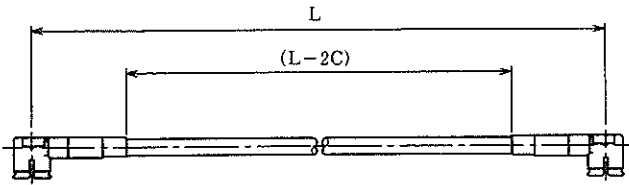

Specify the dimensions from the center of connectors for both single- and double-connector harnesses. Standard dimensional tolerances are as follows:

Overall length	Tolerance
35 ~ 200	±4
201 ~ 500	±8
501 ~ 1000	±12
1001 ~	±1.5%

Note: Minimum length: 35 mm

C Dimensions

H.FL-LP-DFS111 : 6.95
H.FL-LP-A32 : 7.35

PRECAUTIONS FOR HANDLING

▲ Plug

● Connector insertion and extraction

- Hook the tip of the S.FL-LP-N or H.FL-LP-N on the lid, and insert/extract the connector vertically along the connector mating axis. Be sure to hold the connector body when inserting/extracting the connector. Never hold the cable when extracting the cable because it damages the connector.
- Insert the connector as perpendicularly to the

mating surface as possible by aligning the mating axes of both connectors. Do not excessively slant the connectors when inserting.

● Allowable loads on the cable after the connectors are mated.

The figures below show the maximum allowable loads on the cable. Do not apply loads exceeding these values to the cable.

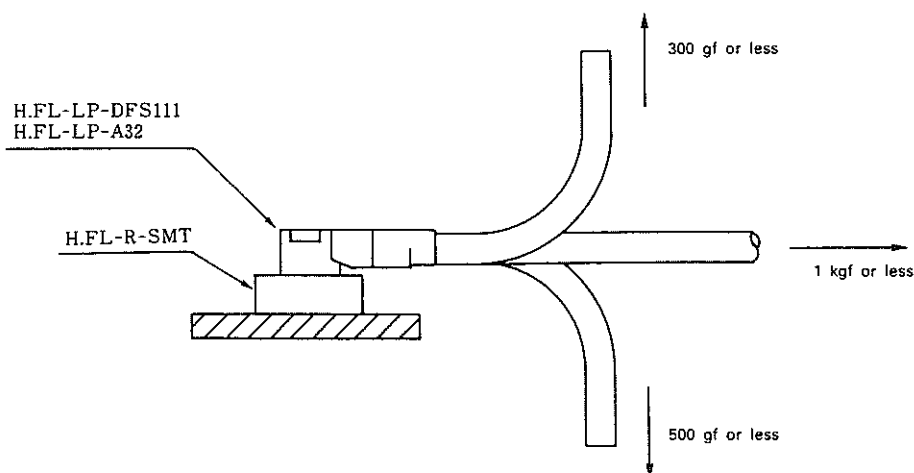

▲ Receptacle

● Dimensions of the land in boards

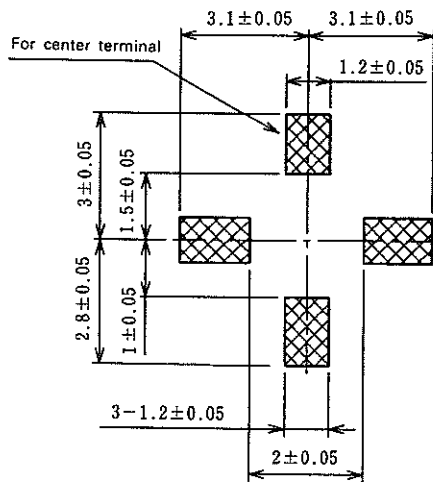

- For land dimensions, strictly follow the values given in the Figure on the left. Otherwise, flux and solder wicking could occur.
- A screen thickness of 0.15 to 0.25 mm is recommended for solder paste printing.

● Packaging temperature profile (reference)

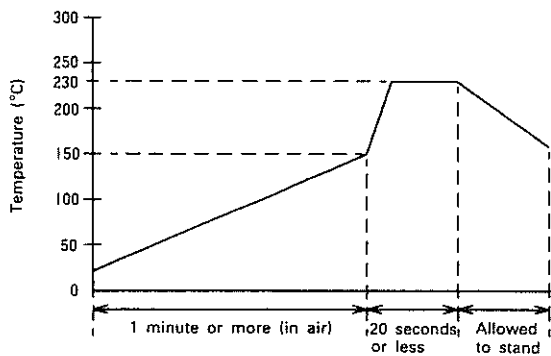

(Note) Complete reflow soldering within 5 seconds at the board surface peak temperature of 240°C or less. The packaging temperature profile varies depending on the board size, type of solder used, and solder thickness.

◆ View of mounted connector

