



Chipsmall Limited consists of a professional team with an average of over 10 year of expertise in the distribution of electronic components. Based in Hongkong, we have already established firm and mutual-benefit business relationships with customers from,Europe,America and south Asia,supplying obsolete and hard-to-find components to meet their specific needs.

With the principle of “Quality Parts,Customers Priority,Honest Operation,and Considerate Service”,our business mainly focus on the distribution of electronic components. Line cards we deal with include Microchip,ALPS,ROHM,Xilinx,Pulse,ON,Everlight and Freescale. Main products comprise IC,Modules,Potentiometer,IC Socket,Relay,Connector.Our parts cover such applications as commercial,industrial, and automotives areas.

We are looking forward to setting up business relationship with you and hope to provide you with the best service and solution. Let us make a better world for our industry!



Contact us

Tel: +86-755-8981 8866 Fax: +86-755-8427 6832

Email & Skype: info@chipsmall.com Web: www.chipsmall.com



Address: A1208, Overseas Decoration Building, #122 Zhenhua RD., Futian, Shenzhen, China







Pulse[®]
A TECHNITROL COMPANY

LAN Product Guide – PC Applications

-  Available for 10/100Base-T and 1000Base-T data rates
-  SMT (surface mount) discrete and THT (through hole) connector modules with integrated magnetics
-  Meets IEEE 802.3 specification

-  Available options: PoE, AutoMDIX, extended temperature, low profile
-  **X** = extended temp, **P** = PoE, **NL** = RoHS compliant, **A** = AutoMDIX,

DESKTOP				LAPTOP / NOTEBOOK			
Gigabit		10/100		Gigabit		10/100	
DISCRETE MAGNETICS				DISCRETE MAGNETICS			
Single H5007NL ^A H5009NL ^A H6062NL ^{P, A}	Dual H5012NL ^A H5014NL ^A H6080NL ^{P, A}	Single H1102NL ^A H2019NL ^{P, A}	Dual H1270NL ^A H2006ANL ^{P, A} H2009NL ^{P, A}	Standard H5007NL ^A H5009NL ^A H6062NL ^{P, A}	Reduced Profile H5015NL ^A H5077NL ^A H5079NL ^A	Standard H1102NL ^A H2019NL ^{P, A}	Low Profile H0020NL H0068ANL ^A H0126NL
CONNECTORS WITH INTEGRATED MAGNETICS				CONNECTORS WITH INTEGRATED MAGNETICS			
1x1 JK0-0036NL ^A JK0654219NL ^A	1x2 JG0-0129NL ^A JG0-0134NL ^A	1x1 J00-0045NL ^A J00-0065NL ^A J1011F21PNL ^A JK0-0025NL ^{P, A}	1x2 J80-0019 ^A J80-0034 ^A J8064D628ANL ^A	1x1 Standard JK0-0036NL ^A JK0654219NL ^A	1x1 Low Profile J0G-0002NL ^A J0G-0009NL ^A	1x1 Standard J00-0045NL ^A J00-0065NL ^A J1011F21PNL ^A JK0-0025NL ^{P, A}	1x1 Low Profile J0G-0007NL ^A
USB/RJ45 COMBO							
10/100 JW0-0009NL	Gigabit JW0-0006NL ^A						

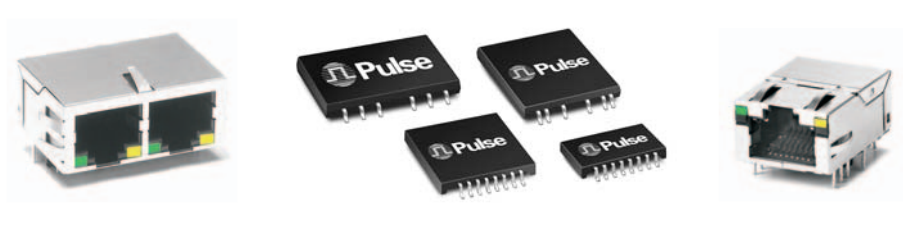



Pulse[®]
A TECHNITROL COMPANY

LAN Product Guide – PC Applications

APPLICATION NOTES

- Layering ground planes is advisable. Route connector/discrete module ground pins to chassis/analog ground if possible.
- Keep signal traces from PHY to connector/discrete module as short as possible. If traces exceed 3-4 inches, pay close attention to line impedance imbalance.
- Using BST (75 Ω resistors and high voltage cap to chassis ground) to terminate Cable side CTs is advisable for best EMI performance (included in most connector solutions).
- Follow PHY manufacturer's application notes for further layout considerations.

10/100 APPLICATION CIRCUIT

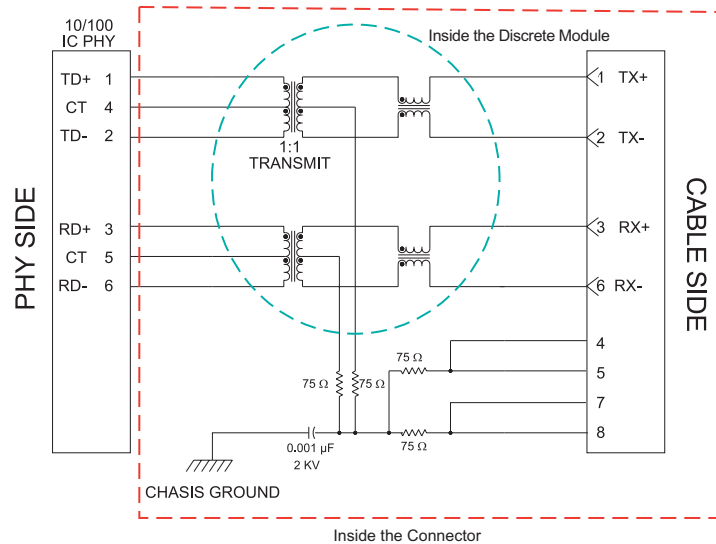

GIGABIT APPLICATION CIRCUIT

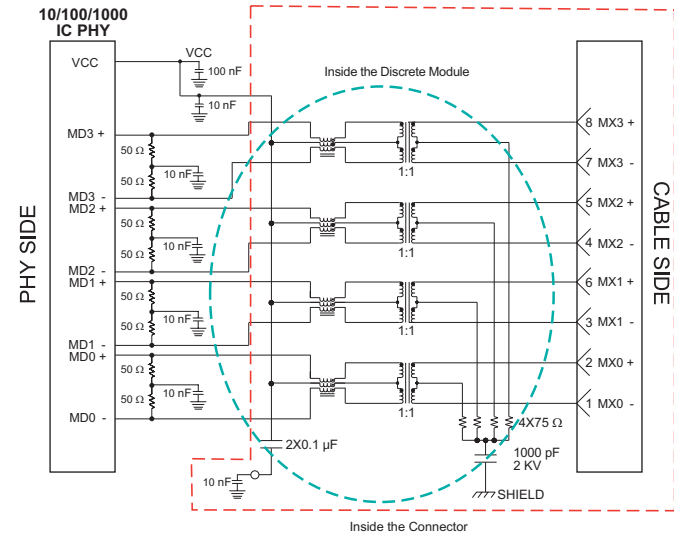

For More Information:

Pulse Worldwide Headquarters

12220 World Trade Dr.
San Diego, CA 92128
U.S.A.

www.pulseeng.com

Tel: 858 674 8100
Fax: 858 674 8262

Pulse Europe

Einsteinstrasse 1
D-71083 Herrenberg
Germany

Tel: 49 7032 7806 116
Fax: 49 7032 7806 135

Pulse China Headquarters

B402, Shenzhen
Tech-Innovation International
Tenth Kejinan Rd.
High-Tech Industrial Park
Nanshan District, Shenzhen
China

Tel: 86 755 33966678
Fax: 86 755 33966700

Pulse North China

Room 1503
XinYin Building
No. 888 YiShan Rd.
Shanghai 200233
China

Tel: 86 21 54643211/2
Fax: 86 21 54643210

Pulse South Asia

150 Kampong Ampat
#07-01/02
KA Centre
Singapore 368324

Tel: 65 6287 8998
Fax: 65 6280 0080

Pulse North Asia

No. 26
Kao Ching Rd.
Yang Mei Chen
Taoyuan Hsien
Taiwan, R. O. C.

Tel: 886 3 4641811
Fax: 886 3 4641911

Performance warranty of products offered on this data sheet is limited to the parameters specified. Data is subject to change without notice. Other brand and product names mentioned herein may be trademarks or registered trademarks of their respective owners. © Copyright, 2007. Pulse Engineering, Inc. All rights reserved.