



Chipsmall Limited consists of a professional team with an average of over 10 year of expertise in the distribution of electronic components. Based in Hongkong, we have already established firm and mutual-benefit business relationships with customers from,Europe,America and south Asia,supplying obsolete and hard-to-find components to meet their specific needs.

With the principle of “Quality Parts,Customers Priority,Honest Operation,and Considerate Service”,our business mainly focus on the distribution of electronic components. Line cards we deal with include Microchip,ALPS,ROHM,Xilinx,Pulse,ON,Everlight and Freescale. Main products comprise IC,Modules,Potentiometer,IC Socket,Relay,Connector.Our parts cover such applications as commercial,industrial, and automotives areas.

We are looking forward to setting up business relationship with you and hope to provide you with the best service and solution. Let us make a better world for our industry!



Contact us

Tel: +86-755-8981 8866 Fax: +86-755-8427 6832

Email & Skype: info@chipsmall.com Web: www.chipsmall.com

Address: A1208, Overseas Decoration Building, #122 Zhenhua RD., Futian, Shenzhen, China



THIS COPY IS PROVIDED ON A RESTRICTED BASIS AND IS NOT TO BE USED IN ANY WAY DETRIMENTAL TO THE INTERESTS OF PANDUIT CORP.

PART NUMBER	SEE DETAIL	"A" +/- .062	"B"	MARKER ACROSS	TUBING COLOR	SEE STYLE	MARKERS PER ROLL
H050X034H1T	A	0.50 [12.70]	0.75 [19.05]	4	WHITE	A	2000
H075X034H1T	B	0.75 [19.05]	1.00 [25.40]	2			1000
H100X034H1T	C	1.00 [25.40]	0.75 [19.05]	2			1000
H150X034H1T	D	1.50 [38.10]	1.00 [25.40]	1			500
H200X034H1T	E	2.00 [50.80]	0.75 [19.05]	1			500
H050X034H2T	A	0.50 [12.70]	0.75 [19.05]	4	YELLOW	A	2000
H075X034H2T	B	0.75 [19.05]	1.00 [25.40]	2			1000
H100X034H2T	C	1.00 [25.40]	0.75 [19.05]	2			1000
H150X034H2T	D	1.50 [38.10]	1.00 [25.40]	1			500
H200X034H2T	E	2.00 [50.80]	0.75 [19.05]	1			500
H050X034H3T	A	0.50 [12.70]	0.75 [19.05]	4	BLACK	A	2000
H075X034H3T	B	0.75 [19.05]	1.00 [25.40]	2			1000
H100X034H3T	C	1.00 [25.40]	0.75 [19.05]	2			1000
H150X034H3T	D	1.50 [38.10]	1.00 [25.40]	1			500
H200X034H3T	E	2.00 [50.80]	0.75 [19.05]	1			500
H050X034H4T	A	0.50 [12.70]	0.75 [19.05]	4	RED	A	2000
H075X034H4T	B	0.75 [19.05]	1.00 [25.40]	2			1000
H100X034H4T	C	1.00 [25.40]	0.75 [19.05]	2			1000
H150X034H4T	D	1.50 [38.10]	1.00 [25.40]	1			500
H200X034H4T	E	2.00 [50.80]	0.75 [19.05]	1			500
H050X034H1T-B	A	0.50 [12.70]	0.75 [19.05]	4	WHITE	B	10000
H075X034H1T-B	B	0.75 [19.05]	1.00 [25.40]	2			5000
H100X034H1T-B	C	1.00 [25.40]	0.75 [19.05]	2			5000
H150X034H1T-B	D	1.50 [38.10]	1.00 [25.40]	1			2500
H200X034H1T-B	E	2.00 [50.80]	0.75 [19.05]	1			2500

NOTES:
1. DIMENSIONS IN [] ARE IN MILLIMETERS.

STYLE A

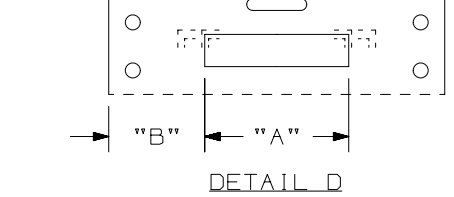
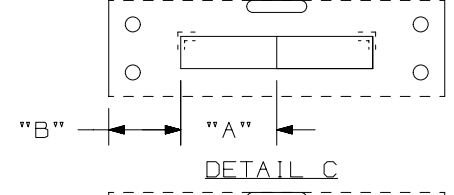
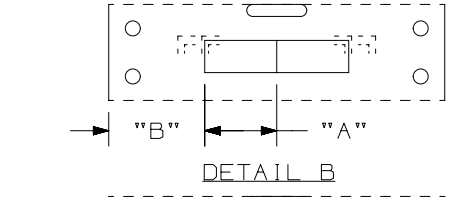
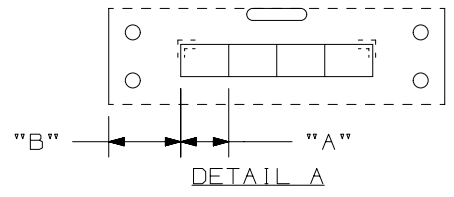
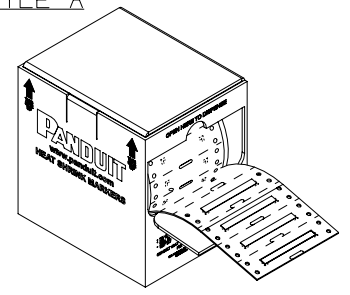

STYLE B

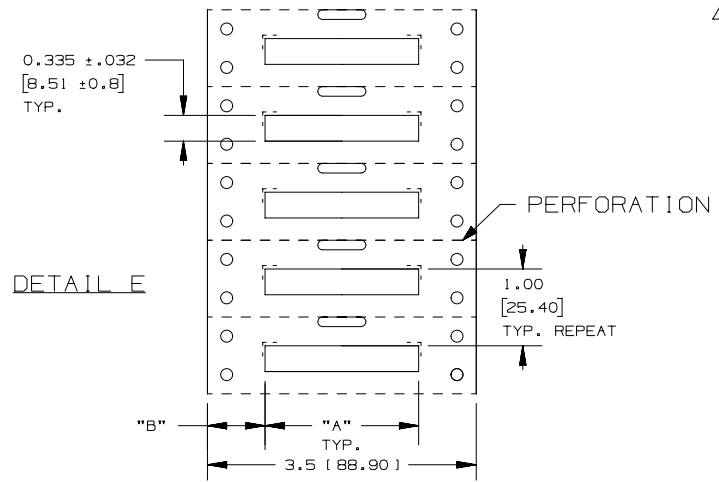
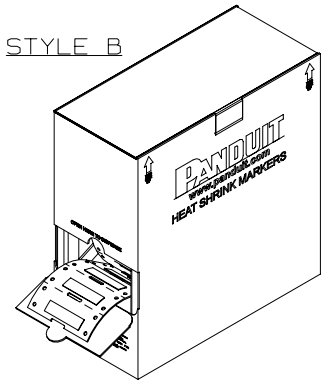

8

REV	DATE	BY	CHK	APR	DESCRIPTION	ECN
8	4/29/15	RVU	SEWH	JHAC	ADD NEW COLUMN OF MARKERS PER ROLL.	GAECN02784
7	1/20/15	RVU	SEWH	MSAD	REVISE OLD LOGO TO CURRENT PANDUIT LOGO.	GAECN02540
6	4/12/12	RVU			REVISED H150 PARTS TO SHOW ALL MARKERS ARE ONLY 1.5" LONG.	6731
5	5/21/09	RVU			+/- .12, +/- .062, +/- .020 WAS +/- .03, +/- .032, +/- .010. HT: .25 +/- .032 WAS .250. MAT'L, HSK TUBING GMUHS31, 3.5 WIDE LINER WAS GMUHS. ADD "A" +/- .062. ADD STYLE B. VIEW FOR BULK BOX.	5593

TITLE	
H***X034H** OPTIMUM COMPUTER PRINTABLE MIL. SPEC. HEAT SHRINK MARKERS CUSTOMER DRAWING	
ITEM REVISION NAME	100923NJ/11
DATASET FILE NAME	100923NJ_DC_C10433/11J
UNLESS OTHERWISE SPECIFIED, DIMENSIONAL TOLERANCES ARE: IN [mm]	
.x ± .12 [3.05]	.xxx ± .020 [0.508]
.xx ± .062 [1.57]	ANGLES ±
THIRD ANGLE PROJECTION	
DRAWN BY	DATE
RVU	8/1/06
CHK	SCALE
MSAD	NTS
MATERIAL:	
HEATSHRINK TUBING GMUHS31, 3.5 WIDE LINER	
DRAWING NUMBER:	
C10433	
REV	SIZE
SHT 1 OF 1	A