



Chipsmall Limited consists of a professional team with an average of over 10 year of expertise in the distribution of electronic components. Based in Hongkong, we have already established firm and mutual-benefit business relationships with customers from,Europe,America and south Asia,supplying obsolete and hard-to-find components to meet their specific needs.

With the principle of “Quality Parts,Customers Priority,Honest Operation,and Considerate Service”,our business mainly focus on the distribution of electronic components. Line cards we deal with include Microchip,ALPS,ROHM,Xilinx,Pulse,ON,Everlight and Freescale. Main products comprise IC,Modules,Potentiometer,IC Socket,Relay,Connector.Our parts cover such applications as commercial,industrial, and automotives areas.

We are looking forward to setting up business relationship with you and hope to provide you with the best service and solution. Let us make a better world for our industry!



Contact us

Tel: +86-755-8981 8866 Fax: +86-755-8427 6832

Email & Skype: info@chipsmall.com Web: www.chipsmall.com

Address: A1208, Overseas Decoration Building, #122 Zhenhua RD., Futian, Shenzhen, China



H21A4

H21A5

H21A6

PACKAGE DIMENSIONS

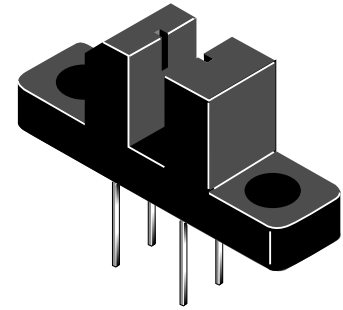
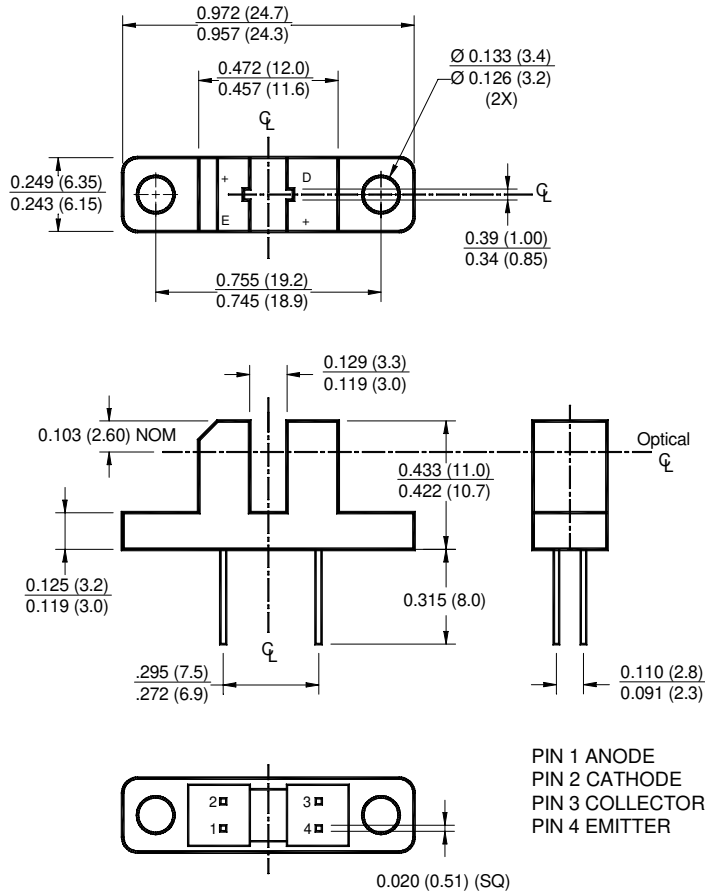

SCHEMATIC

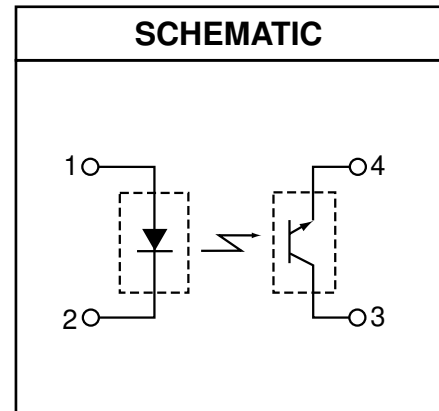

NOTES:

1. Dimensions for all drawings are in inches (mm).
2. Tolerance of $\pm .010$ (.25) on all non-nominal dimensions unless otherwise specified.

DESCRIPTION

The H21A series are gallium arsenide infrared emitting diode coupled with a silicon photodarlington in a plastic housing. The packaging system is designed to optimize the mechanical resolution, coupling efficiency, ambient light rejection, cost and reliability. The gap in the housing provides a means of interrupting the signal with an opaque material, switching the output from an "ON" to an "OFF" state.

FEATURES

- Opaque housing
- Low cost
- .035" apertures
- High $I_{C(ON)}$

H21A4

H21A5

H21A6

ABSOLUTE MAXIMUM RATINGS ($T_A = 25^\circ\text{C}$ unless otherwise specified)

Parameter	Symbol	Rating	Unit
Operating Temperature	T_{OPR}	-55 to +100	$^\circ\text{C}$
Storage Temperature	T_{STG}	-55 to +100	$^\circ\text{C}$
Soldering Temperature (Iron) ^(2,3 and 4)	T_{SOL-I}	240 for 5 sec	$^\circ\text{C}$
Soldering Temperature (Flow) ^(2 and 3)	T_{SOL-F}	260 for 10 sec	$^\circ\text{C}$
INPUT (EMITTER)			
Continuous Forward Current	I_F	50	mA
Reverse Voltage	V_R	6	V
Power Dissipation ⁽¹⁾	P_D	100	mW
OUTPUT (SENSOR)			
Collector to Emitter Voltage	V_{CEO}	55	V
Emitter to Collector Voltage	V_{ECO}	4.5	V
Collector Current	I_C	20	mA
Power Dissipation ($T_C = 25^\circ\text{C}$) ⁽¹⁾	P_D	150	mW

NOTE:

- Derate power dissipation linearly 1.67 mW/ $^\circ\text{C}$ above 25 $^\circ\text{C}$.
- RMA flux is recommended.
- Methanol or isopropyl alcohols are recommended as cleaning agents.
- Soldering iron tip 1/16" (1.6mm) minimum from housing.

ELECTRICAL / OPTICAL CHARACTERISTICS ($T_A = 25^\circ\text{C}$) (All measurements made under pulse conditions)

PARAMETER	TEST CONDITIONS	SYMBOL	DEVICES	MIN	TYP	MAX	UNITS
INPUT (EMITTER)							
Forward Voltage	$I_F = 60 \text{ mA}$	V_F	All	—	—	1.7	V
Reverse Breakdown Voltage	$I_R = 10 \mu\text{A}$	V_R	All	6.0	—	—	μA
Reverse Leakage Current	$V_R = 3 \text{ V}$	I_R	All	—	—	1.0	μA
OUTPUT (SENSOR)							
Emitter to Collector Breakdown	$I_F = 100 \mu\text{A}, E_e = 0$	BV_{ECO}	All	6.0	—	—	V
Collector to Emitter Breakdown	$I_C = 1 \text{ mA}, E_e = 0$	BV_{CEO}	All	55	—	—	V
Collector to Emitter Leakage	$V_{CE} = 45 \text{ V}, E_e = 0$	I_{CEO}	All	—	—	100	nA
COUPLED							
On-State Collector Current	$I_F = 5 \text{ mA}, V_{CE} = 5 \text{ V}$	$I_{C(ON)}$	H21A4	0.15	—	—	mA
			H21A5	0.30	—	—	
			H21A6	0.60	—	—	
	$I_F = 20 \text{ mA}, V_{CE} = 5 \text{ V}$		H21A4	1.0	—	—	
			H21A5	2.0	—	—	
			H21A6	4.0	—	—	
	$I_F = 30 \text{ mA}, V_{CE} = 5 \text{ V}$		H21A4	1.9	—	—	
			H21A5	3.0	—	—	
			H21A6	5.5	—	—	
Saturation Voltage	$I_F = 20 \text{ mA}, I_C = 1.8 \text{ mA}$	$V_{CE(SAT)}$	H21A5/6	—	—	0.40	V
	$I_F = 30 \text{ mA}, I_C = 1.8 \text{ mA}$		H21A4	—	—	0.40	V
Turn-On Time	$I_F = 30 \text{ mA}, V_{CC} = 5 \text{ V}, R_L = 2.5 \text{ K}\Omega$	t_{on}	All	—	8	—	μs
Turn-Off Time	$I_F = 30 \text{ mA}, V_{CC} = 5 \text{ V}, R_L = 2.5 \text{ K}\Omega$	t_{off}	All	—	50	—	μs

TYPICAL PERFORMANCE CURVES

Figure 1. Output Current vs. Input Current

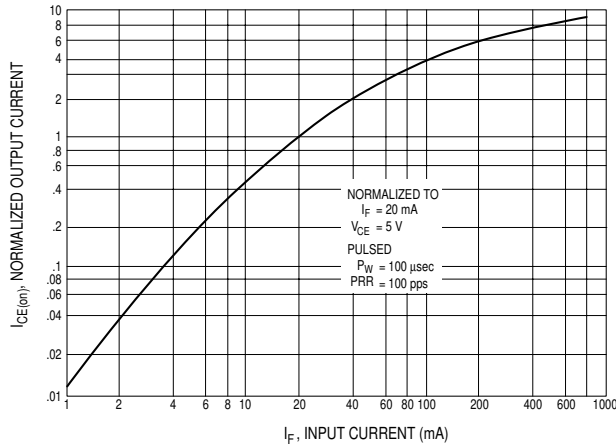

Figure 2. Output Current vs. Temperature

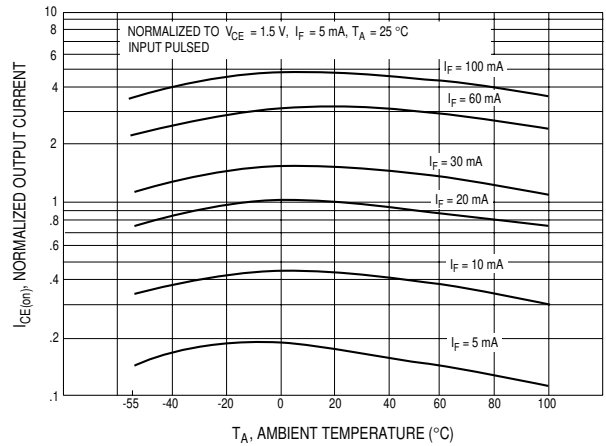

Figure 3. V_{CE(SAT)} vs. Temperature

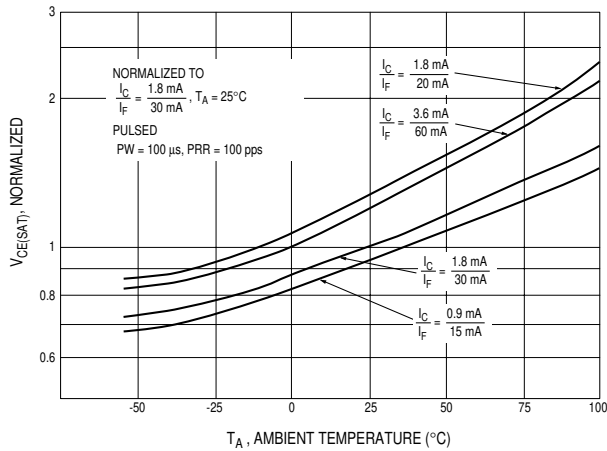

Figure 4. Leakage Current vs. Temperature

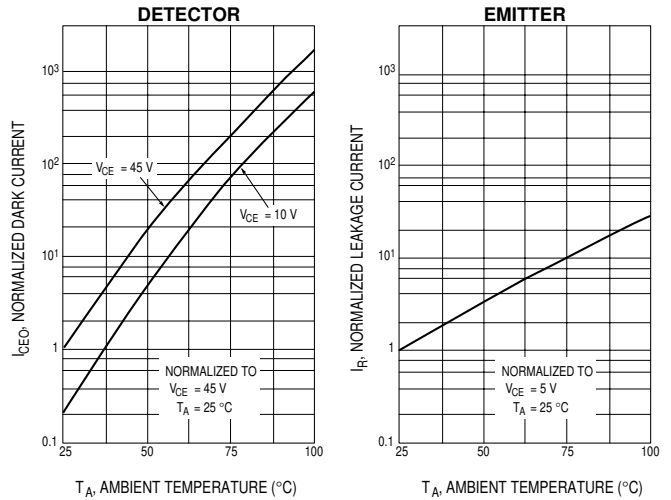

Figure 5. Switching Speed vs. R_L

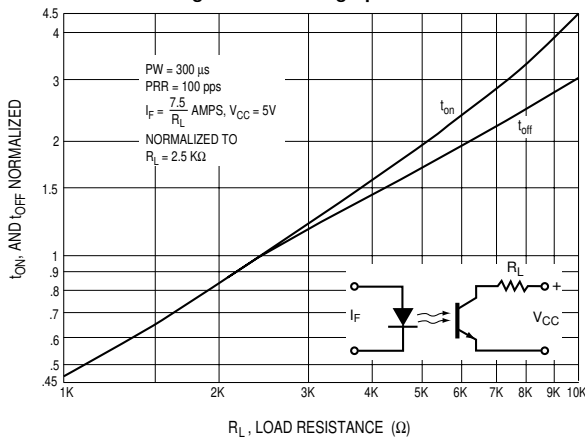
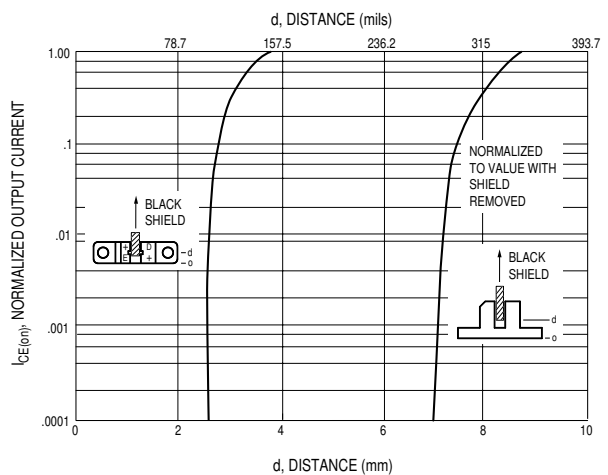

Figure 6. Output Current vs. Distance



H21A4

H21A5

H21A6

DISCLAIMER

FAIRCHILD SEMICONDUCTOR RESERVES THE RIGHT TO MAKE CHANGES WITHOUT FURTHER NOTICE TO ANY PRODUCTS HEREIN TO IMPROVE RELIABILITY, FUNCTION OR DESIGN. FAIRCHILD DOES NOT ASSUME ANY LIABILITY ARISING OUT OF THE APPLICATION OR USE OF ANY PRODUCT OR CIRCUIT DESCRIBED HEREIN; NEITHER DOES IT CONVEY ANY LICENSE UNDER ITS PATENT RIGHTS, NOR THE RIGHTS OF OTHERS.

LIFE SUPPORT POLICY

FAIRCHILD'S PRODUCTS ARE NOT AUTHORIZED FOR USE AS CRITICAL COMPONENTS IN LIFE SUPPORT DEVICES OR SYSTEMS WITHOUT THE EXPRESS WRITTEN APPROVAL OF THE PRESIDENT OF FAIRCHILD SEMICONDUCTOR CORPORATION. As used herein:

1. Life support devices or systems are devices or systems which, (a) are intended for surgical implant into the body, or (b) support or sustain life, and (c) whose failure to perform when properly used in accordance with instructions for use provided in labeling, can be reasonably expected to result in a significant injury of the user.
2. A critical component in any component of a life support device or system whose failure to perform can be reasonably expected to cause the failure of the life support device or system, or to affect its safety or effectiveness.