



Chipsmall Limited consists of a professional team with an average of over 10 year of expertise in the distribution of electronic components. Based in Hongkong, we have already established firm and mutual-benefit business relationships with customers from,Europe,America and south Asia,supplying obsolete and hard-to-find components to meet their specific needs.

With the principle of “Quality Parts,Customers Priority,Honest Operation,and Considerate Service”,our business mainly focus on the distribution of electronic components. Line cards we deal with include Microchip,ALPS,ROHM,Xilinx,Pulse,ON,Everlight and Freescale. Main products comprise IC,Modules,Potentiometer,IC Socket,Relay,Connector.Our parts cover such applications as commercial,industrial, and automotives areas.

We are looking forward to setting up business relationship with you and hope to provide you with the best service and solution. Let us make a better world for our industry!



## Contact us

Tel: +86-755-8981 8866 Fax: +86-755-8427 6832

Email & Skype: info@chipsmall.com Web: www.chipsmall.com

Address: A1208, Overseas Decoration Building, #122 Zhenhua RD., Futian, Shenzhen, China



ITEM	Q'TY	PART NUMBER	PART DESCRIPTION
1	1	H-220C-LP	T-1 (3mm) Bi-Level LED Holder, 90° Mount
2	2	3XX-S	T-1 (3mm) N-Flange Shouldered LED, See Following Pages

REV.	DESCRIPTION	DATE	APPROVED
A	Engineering Update w/o Changes	03/05/04	M. C.
B	Updated to Shouldered LEDs	04/01/08	M. C.
C	Locating Pin Suffix	04/03/12	T. Y.
D	Updated LED Offering List	06/25/12	T. Y.
E	Updated LED Optical Characteristics	09/15/15	J. C.

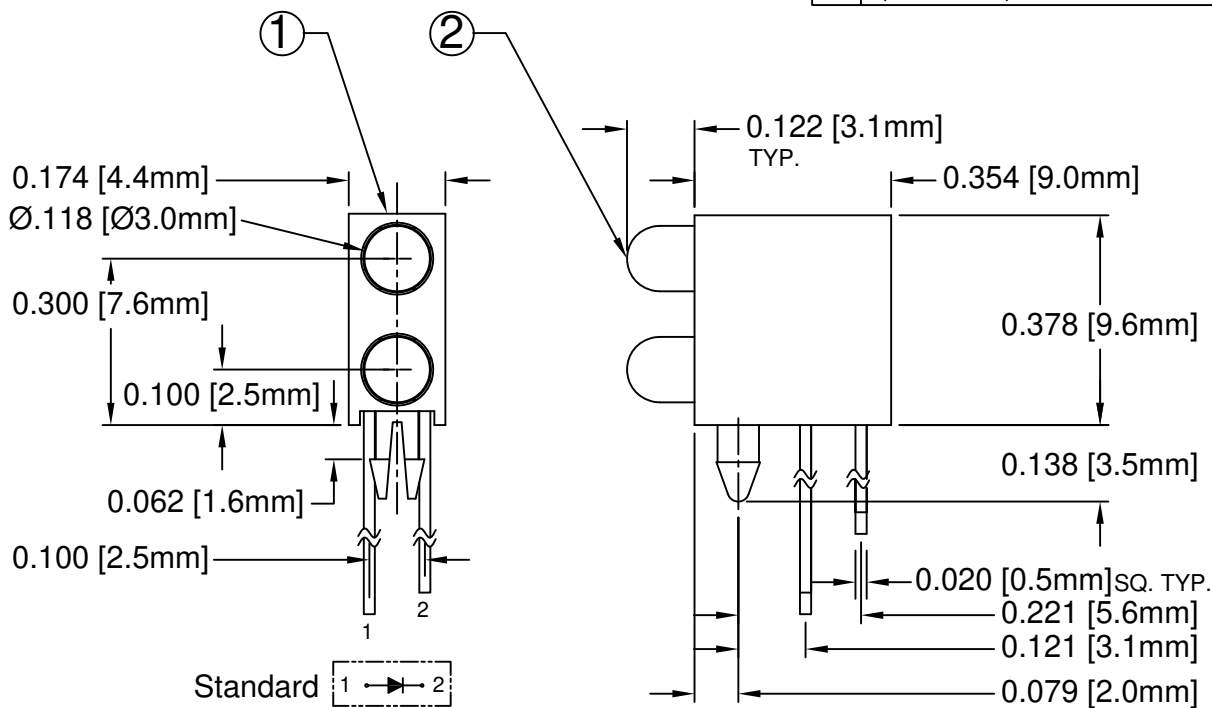

BI-COLOR POLARITY		
LED P/N	(1) Cathode	(2) Cathode
3BC	Green	Red
3BC-Y/G	Green	Yellow
3BC-R/Y	Yellow	Red
3BC-A/G	Green	Amber

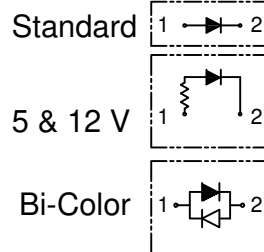
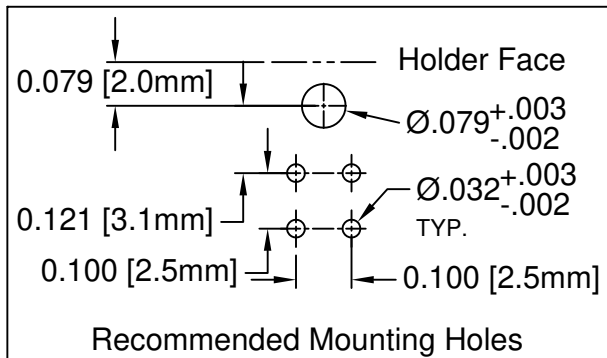

NOTE: P/N DESIGNATION

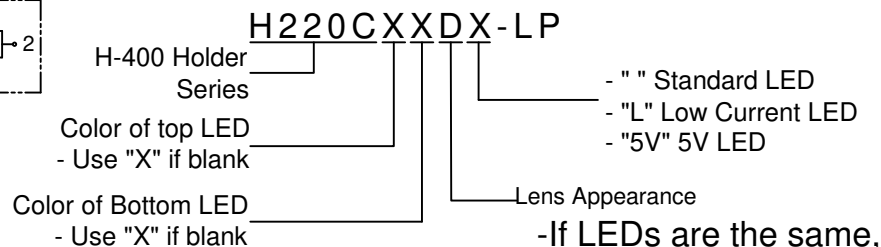

-If LEDs are the same, use e.g. H200CGD

All Green Diffused LEDs

## ABSOLUTE MAXIMUM RATINGS (Ta=25° C)

REVERSE VOLTAGE	5V
REVERSE CURRENT	100µA
OPERATING TEMPERATURE RANGE	-25° C - 85° C
STORAGE TEMPERATURE	-30° C - 100° C
LEAD SOLDERING TEMPERATURE(1/16" FROM BODY)	260° C FOR 5 SECONDS

STANDARD TOLERANCE (UNLESS OTHERWISE SPECIFIED)		BIVAR®	
DECIMALS	ANGULAR	4 THOMAS, IRVINE, CA. 92618	
.X ±.1	X° ±1°	TEL: (949) 951-8808 FAX: (949) 951-3974	
.XX ±.02		TITLE: T-1 (3MM) 90° BI-LEVEL LED LOCATOR PIN LED ASSY	
.XXX ±.010		PART NO: H220CXX-LP	
DESIGNED: T. Yin	DATE: 03/05/04	REVISION: E	
CHECKED: D. Green	DATE: 03/05/04	CAGE CODE : 32559 SHEET # 1 OF 4	
CAD GENERATED DOCUMENT. DO NOT MEASURE DRAWING.			



REV.	DESCRIPTION	DATE	APPROVED
	SEE SHEET#1.		

LED Assy. No.	Chip			Lens Appearance	Electro-Optical Data @ 20mA				Viewing Angle 2 θ ½ (Deg)	LED P/N
	Material	Peak Wave Length	Emitted Color		If (mA)	Vf (V)		Iv (mcd)		
						MAX	TYP	MAX	TYP	
H220CBWC-LP	GaN/SiC	430	BLUE	WATER CLEAR	25	4.0	4.5	25	30	3BWC-S
H220CBWD-LP	GaN/SiC	430	BLUE	DIFFUSED	25	4.0	4.5	10	40	3BWD-S
H220CBWT-LP	GaN/SiC	430	BLUE	TINTED	25	4.0	4.5	25	30	3BWT-S
H220CGC-LP	GaP/GaP	568	GREEN	WATER CLEAR	30	2.1	2.8	40	30	3GC-S
H220CGD-LP	GaP/GaP	568	GREEN	DIFFUSED	30	2.1	2.8	25	40	3GD-S
H220CGT-LP	GaP/GaP	568	GREEN	TINTED	30	2.1	2.8	40	30	3GT-S
H220CPGC-LP	GaP/GaP	555	PURE GREEN	WATER CLEAR	30	2.2	2.8	10	30	3PGC-S
H220CPGD-LP	GaP/GaP	555	PURE GREEN	DIFFUSED	30	2.2	2.8	5	40	3PGD-S
H220CPGT-LP	GaP/GaP	555	PURE GREEN	TINTED	30	2.2	2.8	10	30	3PGT-S
H220CYC-LP	GaAsP/GaP	590	YELLOW	WATER CLEAR	30	2.0	2.8	40	30	3YC-S
H220CYD-LP	GaAsP/GaP	590	YELLOW	DIFFUSED	30	2.0	2.8	20	40	3YD-S
H220CYT-LP	GaAsP/GaP	590	YELLOW	TINTED	30	2.0	2.8	40	30	3YT-S
H220CAC-LP	GaAsP/GaP	605	AMBER	WATER CLEAR	30	2.0	2.8	40	30	3AC-S
H220CAD-LP	GaAsP/GaP	605	AMBER	DIFFUSED	30	2.0	2.8	25	40	3AD-S
H220CAT-LP	GaAsP/GaP	605	AMBER	TINTED	30	2.0	2.8	40	30	3AT-S
H220CHC-LP	GaAsP/GaP	625	HE RED	WATER CLEAR	30	2.0	2.8	50	30	3HC-S
H220CHD-LP	GaAsP/GaP	625	HE RED	DIFFUSED	30	2.0	2.8	30	40	3HD-S
H220CHT-LP	GaAsP/GaP	625	HE RED	TINTED	30	2.0	2.8	50	30	3HT-S
H220CRC-LP	GaP/GaP	700	RED	WATER CLEAR	20	2.1	2.8	2.5	30	3RC-S
H220CRD-LP	GaP/GaP	700	RED	DIFFUSED	20	2.1	2.8	2	40	3RD-S
H220CRT-LP	GaP/GaP	700	RED	TINTED	20	2.1	2.8	2.5	30	3RT-S
H220CBC-A/G-LP	GaAsP/GaP	605	AMBER	DIFFUSED	30	2.0	2.8	6	45	3BC-A/G
	GaP/GaP	568	GREEN		30	2.1	2.8	6		
H220CBC-LP	GaAsP/GaP	625	RED	DIFFUSED	30	2.0	2.8	6	45	3BC
	GaP/GaP	568	GREEN		30	2.1	2.8	6		
H220CBC-R/Y-LP	GaAsP/GaP	625	RED	DIFFUSED	30	2.0	2.8	6	45	3BC-R/Y
	GaAsP/GaP	590	YELLOW		30	2.0	2.8	4		
H220CBC-Y/G-LP	GaAsP/GaP	590	YELLOW	DIFFUSED	30	2.0	2.8	4	45	3BC-Y/G
	GaP/GaP	568	GREEN		30	2.1	2.8	6		

STANDARD TOLERANCE ( UNLESS OTHERWISE SPECIFIED ) ±10% ALL VALUES <u>ANGULAR</u>		 4 THOMAS, IRVINE, CA. 92618 TEL: (949) 951-8808    FAX: (949) 951-3974	
X° ± 5°			
DESIGNED: <b>T. Yin</b>		DATE: <b>03/05/04</b>	
CHECKED: <b>D. Green</b>		DATE: <b>03/05/04</b>	
TITLE: T-1 (3MM) 90° BI-LEVEL LED LOCATOR PIN LED ASSY		REVISION: <b>E</b>	
PART NO: <b>H220CXX-LP</b>		CAGE CODE : <b>32559</b> SHEET # <b>2 OF 4</b>	
CAD GENERATED DOCUMENT. DO NOT MEASURE DRAWING.			

REV.	DESCRIPTION	DATE	APPROVED
	SEE SHEET#1.		

LED Assy. No.	Chip			Lens Appearance	Electro-Optical Data @ 20mA				Viewing Angle 2 θ ½ (Deg)	LED P/N	
	Material	Peak Wave Length	Emitted Color		If (mA)	Vf (V)		Iv (mcd)			
						MAX	TYP	MAX			TYP
H220CUBWC-LP	GaN/SiC	470	BLUE	WATER CLEAR	30	4.0	4.5	400	30	3UBWC-0.6K	
H220CSGC-LP	GaP/GaP	568	GREEN	WATER CLEAR	30	2.1	2.8	50	30	3SGC-S	
H220CSGD-LP	GaP/GaP	568	GREEN	DIFFUSED	30	2.1	2.8	30	40	3SGD-S	
H220CSGT-LP	GaP/GaP	568	GREEN	TINTED	30	2.1	2.8	50	30	3SGT-S	
H220CSYC-LP	GaAsP/GaP	590	YELLOW	WATER CLEAR	30	2.0	2.8	50	30	3SYC-S	
H220CSYD-LP	GaAsP/GaP	590	YELLOW	DIFFUSED	30	2.0	2.8	30	40	3SYD-S	
H220CSYT-LP	GaAsP/GaP	590	YELLOW	TINTED	30	2.0	2.8	50	30	3SYT-S	
H220CSAC-LP	AlGaInP	605	AMBER	WATER CLEAR	30	1.8	2.4	300	30	3SAC-S	
H220CSAD-LP	AlGaInP	605	AMBER	DIFFUSED	30	1.8	2.4	100	40	3SAD-S	
H220CSAT-LP	AlGaInP	605	AMBER	TINTED	30	1.8	2.4	300	30	3SAT-S	
H220CSRC-LP	GaAlAs/GaAs	645	SUPER RED	WATER CLEAR	30	1.7	2.4	60	30	3SRC-S	
H220CSRDLP	GaAlAs/GaAs	645	SUPER RED	DIFFUSED	30	1.7	2.4	40	40	3SRD-S	
H220CSRTL	GaAlAs/GaAs	645	SUPER RED	TINTED	30	1.7	2.4	60	30	3SRT-S	
H220CUGC-LP	AlGaInP	570	GREEN	WATER CLEAR	30	2.1	2.4	200	30	3UGC-S	
H220CSUGC-LP	AlGaInP	570	GREEN	WATER CLEAR	30	2.1	2.4	300	30	3SUGC-S	
H220CUYC-LP	AlGaInP	590	YELLOW	WATER CLEAR	30	2.0	2.4	300	30	3UYC-S	
H220CSUYC-LP	AlGaInP	590	YELLOW	WATER CLEAR	30	2.0	2.4	400	30	3SUYC-S	
H220CUUYC-LP	AlGaInP	590	YELLOW	WATER CLEAR	30	2.0	2.4	600	30	3UUYC-S	
H220CUOC-LP	AlGaInP	625	ORANGE	WATER CLEAR	30	1.8	2.4	300	30	3UOC-S	
H220CSUOC-LP	AlGaInP	625	ORANGE	WATER CLEAR	30	1.8	2.4	400	30	3SUOC-S	
H220CURC-LP	GaAlAs/GaAs	645	RED	WATER CLEAR	30	1.7	2.4	200	30	3URC-S	
H220CSURC-LP	AlGaInP	640	RED	WATER CLEAR	30	1.8	2.4	200	30	3SURC-S	
H220CUWC-LP	InGaN/Sapphire	6500K	WHITE	WATER CLEAR	30	3.2	3.6	5000	30	3UWC1.030C	

STANDARD TOLERANCE ( UNLESS OTHERWISE SPECIFIED ) ±10% ALL VALUES      ANGULAR X° ± 5°		 <b>BIVAR</b> <sup>®</sup> 4 THOMAS, IRVINE, CA. 92618 TEL: (949) 951-8808    FAX: (949) 951-3974	
			
DESIGNED: <b>T. Yin</b>	DATE: <b>03/05/04</b>	<b>TITLE:</b> T-1 (3MM) 90° BI-LEVEL LED LOCATOR PIN LED ASSY	
CHECKED: <b>D. Green</b>	DATE: <b>03/05/04</b>	<b>PART NO:</b> H220CXX-LP	<b>REVISION:</b> E
		<b>CAGE CODE :</b> 32559	<b>SHEET #</b> 3 OF 4
CAD GENERATED DOCUMENT. DO NOT MEASURE DRAWING.			

REV.	DESCRIPTION	DATE	APPROVED
	SEE SHEET#1.		

LED Assy. No.	Chip			Lens Appearance	Absolute Max. Ratings			Electro-Optical Data @ 2mA			Viewing Angle 2 θ ½ (Deg)	LED P/N
	Material	Peak Wave Length λp(nm)	Emitted Color		Pd (mW)	If (mA)	Peak If(mA)	Vf (V)		Iv (mcd)		
								TYP	MAX	TYP		
H220CBWDL-LP	GaN/siC	430	BLUE	DIFFUSED	20	7	-	3.8	4.2	2.5	40	3BWDL-S
H220CGDL-LP	GaP/GaP	568	GREEN	DIFFUSED	10	7	-	2.1	2.6	2.0	40	3GDL-S
H220CPGDL-LP	GaP/GaP	555	PURE GREEN	DIFFUSED	10	7	-	2.1	2.6	0.2	40	3PGDL-S
H220CYDL-LP	GaAsP/GaP	590	YELLOW	DIFFUSED	10	7	-	2.0	2.6	2.0	40	3YDL-S
H220CADL-LP	GaAsP/GaP	605	AMBER	DIFFUSED	10	7	-	2.0	2.6	4.0	40	3ADL-S
H220CHDL-LP	GaAsP/GaP	625	HE RED	DIFFUSED	10	7	-	2.0	2.6	2.5	40	3HDL-S
H220CRDL-LP	GaP/GaP	700	RED	DIFFUSED	10	7	-	2.1	2.6	0.5	40	3RDL-S
H220CSRDL-LP	GaAlAs/GaAs	645	RED	DIFFUSED	10	7	-	2.0	-	8.0	40	3SRDL-S

LED Assy. No.	Peak Wave Length λp(nm)	Emitted Color	Lens Appearance	Electro-Optical Data				Viewing Angle 2 θ½ (Deg)	LED P/N
				If (mA)	Vf (V)		Iv (mcd)		
					MAX	TYP	MAX		
<b>5 Volt</b>				<b>Data @ 5V</b>					
H220CBWD5V-LP	BLUE	430	DIFFUSED	-	-	5	10	35	3BWD5V-S
H220CGC5V-LP	GREEN	568	WATER CLEAR	-	-	5	40	20	3GC5V-S
H220CGD5V-LP	GREEN	568	DIFFUSED	-	-	5	25	35	3GD5V-S
H220CGT5V-LP	GREEN	568	TINTED	-	-	5	40	20	3GT5V-S
H220CAD5V-LP	AMBER	605	DIFFUSED	-	-	5	25	35	3AD5V-S
H220CHD5V-LP	HE RED	625	DIFFUSED	-	-	5	30	35	3HD5V-S
H220CRD5V-LP	RED	700	DIFFUSED	-	-	5	2	35	3RD5V-S
H220CYD5V-LP	YELLOW	590	DIFFUSED	-	-	5	20	35	3YD5V-S
<b>12 Volt</b>				<b>Data @ 12V</b>					
H220CGC12V-LP	GREEN	568	WATER CLEAR	-	-	12	40	20	3GC12V-S
H220CGD12V-LP	GREEN	568	DIFFUSED	-	-	12	25	35	3GD12V-S
H220CHC12V-LP	HE RED	625	WATER CLEAR	-	-	12	50	20	3HC12V-S
H220CHD12V-LP	HE RED	625	DIFFUSED	-	-	12	30	35	3HD12V-S
H220CRC12V-LP	RED	700	WATER CLEAR	-	-	12	6	20	3RC12V-S
H220CRD12V-LP	RED	700	DIFFUSED	-	-	12	2	35	3RD12V-S
H220CYC12V-LP	YELLOW	590	WATER CLEAR	-	-	12	40	20	3YC12V-S
H220CYD12V-LP	YELLOW	590	DIFFUSED	-	-	12	25	35	3YD12V-S

STANDARD TOLERANCE ( UNLESS OTHERWISE SPECIFIED ) ±10% ALL VALUES		 <b>BIVAR</b> <sup>®</sup> 4 THOMAS, IRVINE, CA. 92618 TEL: (949) 951-8808 FAX: (949) 951-3974	
ANGULAR X° ± 5°			
DESIGNED: <b>T. Yin</b>		DATE: <b>03/05/04</b>	
CHECKED: <b>D. Green</b>		DATE: <b>03/05/04</b>	
TITLE: T-1 (3MM) 90° BI-LEVEL LED LOCATOR PIN LED ASSY		PART NO: <b>H220CXX-LP</b>	
REVISION: <b>E</b>		CAGE CODE : <b>32559</b> SHEET # <b>4 OF 4</b>	
CAD GENERATED DOCUMENT. DO NOT MEASURE DRAWING.			