



Chipsmall Limited consists of a professional team with an average of over 10 year of expertise in the distribution of electronic components. Based in Hongkong, we have already established firm and mutual-benefit business relationships with customers from,Europe,America and south Asia,supplying obsolete and hard-to-find components to meet their specific needs.

With the principle of “Quality Parts,Customers Priority,Honest Operation,and Considerate Service”,our business mainly focus on the distribution of electronic components. Line cards we deal with include Microchip,ALPS,ROHM,Xilinx,Pulse,ON,Everlight and Freescale. Main products comprise IC,Modules,Potentiometer,IC Socket,Relay,Connector.Our parts cover such applications as commercial,industrial, and automotives areas.

We are looking forward to setting up business relationship with you and hope to provide you with the best service and solution. Let us make a better world for our industry!



## Contact us

Tel: +86-755-8981 8866 Fax: +86-755-8427 6832

Email & Skype: info@chipsmall.com Web: www.chipsmall.com

Address: A1208, Overseas Decoration Building, #122 Zhenhua RD., Futian, Shenzhen, China



# Digital Timer

## H5CX-□-N

### Ultra-compact Timer Provides Advanced Functions and Security Settings.



#### Basic Features

- Short body with depth of only 59 mm (for 24-VAC / 12 to 24-VDC Models with Screw Terminals). \*1
- Character height of 12 mm for better readability (on models with 4 digits).
- The present value display characters can be switched between red, green, and orange. \*2

#### Safety and Reliability

- Power supply circuit and input circuits are isolated for safety and reliability. \*3
- New set value limit and output counter functions have been added. \*4

#### Other Features

- Front Panel can be changed to white or light gray. \*5
- Models with instantaneous contact output added to the series.

- \*1. For 100 to 240 VAC Models with Screw Terminals 78 mm, Models with Sockets: 63.7 mm (case dimension).
- \*2. The H5CX-A11, H5CX-L8 and H5CX-B Timers have only red characters.
- \*3. Specifications: 100 to 240 VAC
- \*4. The value of the output counter can only be monitored. It cannot be reset.
- \*5. Replacement Front Panels sold separately.



For the most recent information on models that have been certified for safety standards, refer to your OMRON website.

Refer to "Safety Precautions" on page 41.

## Features

### Basic Features

#### Ultra Short Body

The body depth has been greatly reduced. Helps in making thinner control panels. (Models with Screw Terminals)

24-VAC / 12 to 24-VDC Models with Screw Terminals: 59 mm  
 100 to 240-VAC / VDC Models with Screw Terminals: 78 mm \*  
 Models with Sockets: 63.7 mm (case dimension)

\* The shortest body for a timer with isolated power supply and input circuits and a maximum ambient temperature of 55°C (according to OMRON investigation in June 2009).

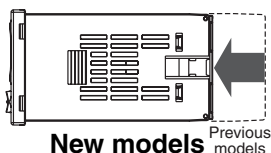

#### Easier to Read

For better readability, the character height for the present value display is 12 mm (on models with 4 digits), the largest class in the industry. The wide viewing angle and brightness provide excellent visibility. The number of display segments has also been increased to make settings easier to understand, and the present value display can be switched between red, green and orange so that output status can be seen from a distance.

Model with 4 Digits    Model with 6 Digits



down (Display example)

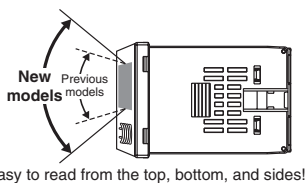

Note: The H5CX-A11 and H5CX-L8 Timers have only red characters.

#### The Easiest Operation

Operation is simplified by the Up/Down Keys for each digit on 4-digit models and Up Keys for each digit on 6-digit models.

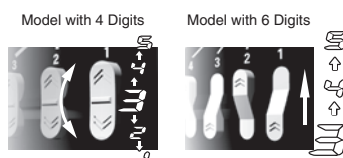

### Safety and Reliability

#### Isolated Power Supply and Input Circuits \*1

Power supply circuit and input circuits are isolated for safety and reliability.

Previous non-isolated timers had wiring restrictions and could be damaged if wired incorrectly. The New H5CX removes these worries.

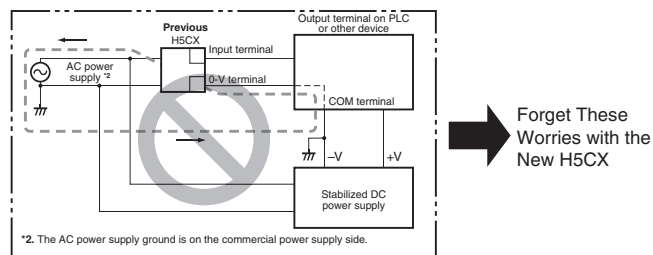

\*2. The AC power supply ground is on the commercial power supply side.

Forget These Worries with the New H5CX

\*1. New Models (H5CX-□-N) with 100 to 240-VAC specifications.

#### Set Value Limit

You can set an upper limit for the set value to prevent unexpected operation of output devices caused by setting mistakes.



#### Output Counter

An output counter counts the number of times that the output turns ON. (An alarm can be set and the value of the output counter can be monitored, Unit: 1,000 operations.) This counter is useful in managing the service life of the Timer or the load.

## Other Features

### Change the Front Panel Color

The Front Panel can be replaced with an optional Front Panel (order separately) with a different color to match the installation site. Select from black, white, and light gray.

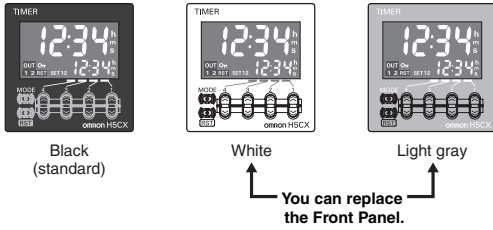

### Models with Instantaneous Contact Output

Models with instantaneous contact outputs have been added to the lineup for use with self-holding circuits and as auxiliary relays. These models are also convenient when replacing analog timers.

### Universal NPN/PNP Input

DC 2-wire sensors can be connected for a wide range of input devices.

### Waterproof, Dust-proof Structure (UL508 Type 4X and IP66)

Worry-free application is possible in locations subject to water.  
**Note:** When the Y92S-29 Waterproof Packing is used.

### Key Protection

Select from any of seven protection patterns. Use the best one for the application.

### New Modes

Modes, such as a stopwatch mode (Mode S), have been added. Select any of 15 modes.

## Model Number Structure

### Model Configuration

		H5CX Series				
		Standard Type H5CX-A Series		Economy Type H5CX-L Series		Six-digit Type
Type						
Model		H5CX-A□-N	H5CX-A11□-N	H5CX-L8□-N	H5CX-L8E□-N	H5CX-BWSD-N
Function	Timer	Yes		Yes		No
	Twin timer	Yes		Yes		No
	Two-stage settings/ forecast output	No		No		Yes
Operating modes	Timer Mode: 11 modes Twin Timer Mode: 4 modes			Timer Mode : 4 modes Twin Timer Mode : 2 modes		Timer Mode: 2 modes
Input	NPN/PNP input		NPN input	None		NPN/PNP input
External connections	Screw terminal block	11-pin socket		8-pin socket		Screw terminal block
Present value display character color	Red, green, or orange	Red				
Number of display digits	4					6
Instantaneous contacts	None			Provided		None
Gate input	Supported		Not supported			Supported
DIP switch settings	Provided		None			Provided
Power supply voltage	100 to 240 VAC or 24 VAC/12 to 24 VDC					12 to 24 VDC

**Model Number Legend** (Not all possible combinations of functions are available.)

H5CX-□□□□□-N

1	2	3	4	5
---	---	---	---	---

**1. Type Classifier**

Symbol	Meaning
A	Standard type
B	6-digit type
L	Economy type

**4. Output type**

Symbol	Meaning
None	Contact output (time-limit SPDT)
E	Contact output (time-limit SPDT + instantaneous SPDT) *
S	Transistor output

\* Can be used as a time-limit DPDT output.

**2. External Connections**

Symbol	Meaning
None	Screw terminals
8	8-pin socket
11	11-pin socket

**5. Supply voltage**

Symbol	Meaning
None	100 to 240 VAC 50/60 Hz
D	12 to 24 VDC/24 VAC 50/60 Hz *

\* The H5CX-BWSD-N is available only for 12 to 24 VDC.

**3. Settings**

Symbol	Meaning
None	One stage
W	Two stages

**Note:** Estimates can be provided for coatings and other specifications that are not given in the datasheet. Ask your OMRON representative for details.**Ordering Information****List of Models**

Type	Time specifications	Operating modes	External connections	Inputs	Outputs	Supply voltage	Models
H5CX-A	0.001 to 9.999 s 0.01 to 99.99 s 0.1 to 999.9 s 1 to 9999 s 1 s to 99 min 59 s 0.1 to 999.9 min 1 to 9999 min 1 min to 99 h 59 min 0.1 to 999.9 h 1 to 9999 h	Timer Mode A: Signal ON Delay I A-1: Signal ON Delay II A-2: Power ON Delay I A-3: Power ON Delay II b: Repeat cycle 1 b-1: Repeat cycle 2 d: Signal OFF Delay E: Interval F: Cumulative Z: ON/OFF-duty-adjustable flicker S: Stopwatch  Twin Timer Mode toff: Flicker OFF Start 1 ton: Flicker ON Start 1 toff-1: Flicker OFF Start 2 ton-1: Flicker ON Start 2	Screw terminals	Signal, Reset, Gate (NPN/ PNP inputs)	Contact output (time-limit SPDT)	100 to 240 VAC	H5CX-A-N
					Transistor output (SPST)	12 to 24 VDC/ 24 VAC	H5CX-AD-N
						100 to 240 VAC	H5CX-AS-N
			11-pin socket		Contact output (time-limit SPDT)	12 to 24 VDC/ 24 VAC	H5CX-ASD-N
					Transistor output (SPST)	100 to 240 VAC	H5CX-A11-N
						12 to 24 VDC/ 24 VAC	H5CX-A11D-N
H5CX-L	1 s to 99 min 59 s 0.1 to 999.9 min 1 to 9999 min 1 min to 99 h 59 min 0.1 to 999.9 h 1 to 9999 h	Twin Timer Mode toff: Flicker OFF Start 1 ton: Flicker ON Start 1 toff-1: Flicker OFF Start 2 ton-1: Flicker ON Start 2  Timer Mode A-2: Power ON Delay I b: Repeat cycle 1 E: Interval Z: ON/OFF-duty-adjustable flicker  Twin Timer Mode toff: Flicker OFF Start 1 ton: Flicker ON Start 1	8-pin socket	Signal, Reset (NPN inputs)	Contact output (time-limit SPDT)	100 to 240 VAC	H5CX-L8-N
					Transistor output (SPST)	12 to 24 VDC/ 24 VAC	H5CX-L8D-N
						100 to 240 VAC	H5CX-L8S-N
			None		Contact output (time-limit SPDT + instantaneous SPDT)	12 to 24 VDC/ 24 VAC	H5CX-L8SD-N
						100 to 240 VAC	H5CX-L8E-N
					Models with instantaneous contact outputs	12 to 24 VDC/ 24 VAC	H5CX-L8ED-N
H5CX-B	0.01 to 9999.99 s 1 s to 99 h 59 min 59 s 0.1 to 99999.9 min 0.1 to 99999.9 h	A: Signal ON Delay I F-1: Cumulative	Screw terminals	Signal, Reset, Gate (NPN/ PNP inputs)	Transistor output (DPST)	12 to 24 VDC	H5CX-BWSD-N

**Note:** 1. The functions that are provided depend on the model. Check detailed specifications before ordering.2. Refer to **page 33** and later for information on H5CX-B Timers (6-digit display).

## Accessories (Order Separately)

### Front Panels (Replacement Parts)

Models	Color	Applicable Timers	Page
Y92P-CXT4G	Light gray (5Y7/1)	Four-digit models	12
Y92P-CXT4S	White (5Y9.2 / 0.5)		
Y92P-CXT4B	Black (N1.5)		

**Note:** 1. You can change the color of the front panel when mounting the Timer. The Timer is shipped with a black (N1.5) Front Panel.  
 2. "TIMER" is printed on the front of Replacement Front Panels.

### Soft Cover

Models	Remarks	Page
Y92A-48F1	---	12

### Hard Cover

Models	Remarks	Page
Y92A-48	---	12

### Flush Mounting Adapter

Models	Remarks	Page
Y92F-30	Included with models with terminal blocks.	12
Y92F-45	Use this Adapter to install the Timer in a cutout previously made for a DIN 72 x 72 mm device (panel cutout: 68 x 68 mm).	

### Waterproof Packing

Models	Remarks	Page
Y92S-29	Included with models with terminal blocks.	12

### Connection Sockets

Models	Type	Connectable Timers	Remarks	Page
P2CF-08	Front Connecting Socket	H5CX-L8□	Round crimp terminals cannot be used on Finger-safe Sockets. Use forked crimp terminals.	13
P2CF-08-E	Front Connecting Socket (Finger-safe Type)			
P2CF-11	Front Connecting Socket	H5CX-A11□	Round crimp terminals cannot be used on Finger-safe Sockets. Use forked crimp terminals.	
P2CF-11-E	Front Connecting Socket (Finger-safe Type)			
P3G-08	Back Connecting Socket	H5CX-L8□	A Y92A-48G Terminal Cover can be used with the Socket to create a finger-safe construction.	
P3GA-11		H5CX-A11□		

### Terminal Covers for P3G-08 and P3GA-11 Back-connecting Sockets

Models	Remarks	Page
Y92A-48G	---	14



**H5CX-A□-N/-L□-N Digital Timers**

- Switch the display color\* between red, green, and orange to see the output status from a distance.
- Up/Down Keys for each digit enable easy operation.
- Cyclic control is easy with the Twin Timer and Variable ON/OFF Duty modes.

\* Not supported by the H5CX-A11□ or H5CX-L8□.



For the most recent information on models that have been certified for safety standards, refer to your OMRON website.

**Specifications**

**Ratings**

Item	Models	H5CX-A□-N	H5CX-A11□-N	H5CX-L8□-N
<b>Classification</b>		Standard Type		Economy Type
<b>Ratings</b>	<b>Power supply voltage *1</b>	<ul style="list-style-type: none"> <li>• 100 to 240 VAC 50/60 Hz</li> <li>• 12 to 24 VDC/24 VAC 50/60 Hz</li> </ul>		
	<b>Operating voltage fluctuation range</b>	85% to 110% of rated supply voltage (90% to 110% at 12 to 24 VDC)		
	<b>Power consumption</b>	Approx. 6.2 VA at 100 to 240 VAC, Approx. 5.1 VA/2.4 W at 24 VAC/12 to 24 VDC *2		
<b>Mounting method</b>		Flush mounting	Flush mounting, surface mounting, DIN track mounting	
<b>External connections</b>		Screw terminals	11-pin socket	8-pin socket
<b>Degree of protection</b>		IEC IP66, UL508 Type 4X (indoors) for panel surface only and when Y92S-29 Waterproof Packing is used		
<b>Digits</b>		4 digits		
<b>Time ranges</b>		0.001 s to 9.999 s, 0.01 s to 99.99 s, 0.1 s to 999.9 s, 1 s to 9999 s, 1 s ti 99 min 59 s 0.1 m to 999.9 min, 1 min to 9999 min, 1 min to 99 h 59 min, 0.1 h to 999.9 h, 1 h to 9999 h		
<b>Timer mode</b>		Elapsed time (Up), remaining time (Down) (selectable)		
<b>Inputs</b>	<b>Input signals</b>	Signal, Reset, Gate		Signal, Reset (no inputs on models with instantaneous contact outputs)
	<b>Input method</b>	No-voltage Input ON impedance: 1 kΩ max. (Leakage current: 12 mA when 0 Ω) ON residual voltage: 3 V max. OFF impedance: 100 kΩ min. Voltage Input High (logic) level: 4.5 to 30 VDC Low (logic) level: 0 to 2 VDC (Input resistance: approx. 4.7 kΩ) No-voltage input/voltage input (switchable)		No-voltage Input ON impedance: 1 kΩ max. (Leakage current: 12 mA when 0 Ω) ON residual voltage: 3 V max. OFF impedance: 100 kΩ min.
	<b>Signal, reset, gate</b>	Minimum input signal width: 1 or 20 ms (selectable, same for all input)		
<b>Reset system</b>		Power reset (depending on output mode), external reset, manual reset, automatic reset (depending on output mode)		
<b>Power reset</b>		Minimum power-opening time: 0.5 s (except for A-3, b-1, F, ton-1, and toff-1 mode)		
<b>Reset voltage</b>		10% max. of rated supply voltage		
<b>Sensor waiting time</b>		250 ms max. (Control output is turned OFF and no input is accepted during sensor waiting time.)		
<b>Output</b>	<b>Output modes</b>	A: Signal ON Delay I, A-1: Signal ON Delay II, A-2: Power ON Delay I, A-3: Power ON Delay II, b: Repeat Cycle 1, b-1: Repeat Cycle 2, d: Signal OFF Delay, E: Interval, F: Cumulative, Z: ON/OFF-duty-adjustable flicker, S: Stopwatch, toff: Flicker OFF Start 1, ton: Flicker ON Start 1, toff-1: Flicker OFF Start 2, ton-1: Flicker ON Start 2		Models with Instantaneous Contact Outputs A-2: Power ON Delay I, b: Repeat Cycle 1, E: Interval, Z: ON/OFF-duty-adjustable flicker, toff: Flicker OFF Start 1, ton: Flicker ON Start 1
	<b>One-shot output time</b>	0.01 to 99.99 s		
	<b>Control output</b>	<ul style="list-style-type: none"> <li>• Models with Contact Outputs 5 A at 250 VAC/30 VDC, resistive load (cos = 1) Minimum applied load: 10 mA at 5 VDC (failure level: P, reference value) Contact materials : AgSnIn</li> <li>• Transistor output: NPN open collector, 100 mA at 30 VDC max., residual voltage: 1.5 VDC max. (Approx. 1 V), Leakage current: 0.1 mA max.</li> </ul>		
<b>Display method *3</b>		7-segment, negative transmissive LCD; Present value: 12-mm-high characters, (switchable between red, green, and orange) Set value: 6-mm-high characters, green	7-segment, negative transmissive LCD; Present value: 12-mm-high characters, red Set value: 6-mm-high characters, green	
<b>Memory backup</b>		EEPROM (overwrites: 100,000 times min.) that can store data for 10 years min.		
<b>Operating temperature range</b>		-10 to 55°C (-10 to 50°C if counters are mounted side by side) (with no icing or condensation)		
<b>Storage temperature range</b>		-25 to 70°C (with no icing or condensation)		
<b>Operating humidity range</b>		25% to 85%		
<b>Case color</b>		Black (N1.5) (Optional Front Panels are available to change the Front Panel color to light gray or white.)		
<b>Attachments</b>		Waterproof packing, flush mounting adapter, label for DIP switch settings	Label for DIP switch settings	---

\*1. Do not use the output from an inverter as the power supply. The ripple must be 20% maximum for DC power.

\*2. Inrush current will flow for a short time when the power supply is turned ON.  
Inrush Current (Reference Values)

Voltage	Applied voltage	Inrush current (peak value)	Time
100 to 240 VAC	264 VAC	5.3 A	0.4 ms
	26.4 VAC	6.4 A	1.4 ms
12 to 24 VDC/24 VAC	26.4 VDC	4.4 A	1.7 ms

\*3. The display is lit only when the power is ON. Nothing is displayed when power is OFF.

## Characteristics

<b>Accuracy of operating time and setting error (including temperature and voltage influences)</b>	Power-ON start: $\pm 0.01\% \pm 50$ ms max. (See note 1.) Signal start: $\pm 0.005\% \pm 30$ ms max. (See note 1.) Signal start for transistor output model: $\pm 0.005\% \pm 3$ ms max. (See note 1 and 2.) If the set value is within the sensor waiting time at startup the control output of the H5CX will not turn ON until the sensor waiting time passes. <b>Note:</b> 1. The values are based on the set value. 2. The value is applied for a minimum pulse width of 1 ms.	
<b>Insulation resistance</b>	100 M $\Omega$ min. (at 500 VDC) between current-carrying terminal and exposed non-current-carrying metal parts, and between non-continuous contacts	
<b>Dielectric strength</b>	2,000 VAC, 50/60 Hz for 1 min between current-carrying metal parts and non-current-carrying metal parts 2,000 VAC, 50/60 Hz for 1 min between power supply and input circuits for the models other than H5CX-□D-N 1,000 VAC, 50/60 Hz for 1 min between control output, power supply, and input circuits for H5CX-□SD-N 2,000 VAC, 50/60 Hz for 1 min between control output, power supply, and input circuits for other models 1,000 VAC, 50/60 Hz for 1 min between non-continuous contacts	
<b>Impulse withstand voltage</b>	5 kV (between power terminals) for 100 to 240 VAC, 1 kV for 24 VAC/12 to 24 VDC 5 kV (between current-carrying terminal and exposed non-current-carrying metal parts) for 100 to 240 VAC 1.5 kV for 24 VAC/12 to 24 VDC	
<b>Noise immunity</b>	$\pm 1.5$ kV (between power terminals) and $\pm 600$ V (between input terminals), square-wave noise by noise simulator (pulse width: 100 ns/1 $\mu$ s, 1-ns rise)	
<b>Static immunity</b>	Malfunction: 8 kV Destruction: 15 kV	
<b>Vibration resistance</b>	<b>Destruction</b>	10 to 55 Hz with 0.75-mm single amplitude each in three directions for 2 h each
	<b>Malfunction</b>	10 to 55 Hz with 0.35-mm single amplitude each in three directions for 10 min each
<b>Shock resistance</b>	<b>Destruction</b>	300 m/s <sup>2</sup> in three directions, three cycles
	<b>Malfunction</b>	100 m/s <sup>2</sup> in three directions, three cycles
<b>Life expectancy</b>	<b>Mechanical</b>	10,000,000 operations min. (under no load at 1,800 operations/h and ambient temperature of 23°C)
	<b>Electrical</b>	100,000 operations min. (5 A at 250 VAC, resistive load at 1,800 operations/h and ambient temperature of 23°C) *
<b>Weight</b>	Approx. 115 g (Timer only)	

\* Refer to Life-test Curve.

## Life-test Curve (Reference Values)

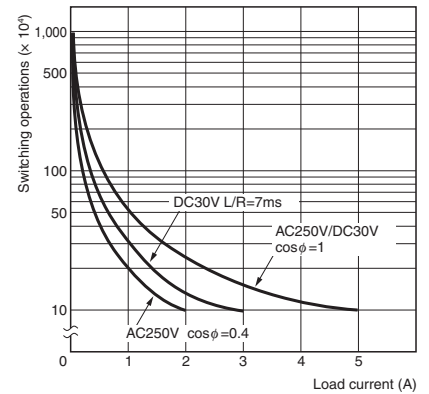

A maximum current of 0.15 A can be switched at 125 VDC (cosφ = 1) and a maximum current of 0.1 A can be switched if L/R is 7 ms. In both cases, a life of 100,000 operations can be expected.

## Applicable Standards

<b>Approved safety standards</b>	UL508/Listing, UL508 Type 4X for indoor use (enclosure rating), CSA C22.2 No. 14 <b>*1</b> , conforms to EN61812-1 (Pollution degree 2/overvoltage category III) B300 PILOT DUTY 1/4 HP 120 VAC, 1/3 HP, 240 VAC, 5 A resistive load VDE0106/P100 CCC: Pollution degree 2, Overvoltage category II <b>*2</b>																				
<b>EMC</b>	<table border="0"> <tr> <td>(EMI)</td> <td>EN61812-1</td> </tr> <tr> <td>Emission Enclosure:</td> <td>EN55011 Group 1 class A</td> </tr> <tr> <td>Emission AC mains:</td> <td>EN55011 Group 1 class A</td> </tr> <tr> <td>(EMS)</td> <td>EN61812-1</td> </tr> <tr> <td>Immunity ESD:</td> <td>IEC61000-4-2</td> </tr> <tr> <td>Immunity RF-interference:</td> <td>IEC61000-4-3</td> </tr> <tr> <td>Immunity Burst:</td> <td>IEC61000-4-4</td> </tr> <tr> <td>Immunity Surge:</td> <td>IEC61000-4-5</td> </tr> <tr> <td>Immunity Conducted Disturbance:</td> <td>IEC61000-4-6</td> </tr> <tr> <td>Immunity Voltage Dip/Interruption:</td> <td>IEC61000-4-11</td> </tr> </table>	(EMI)	EN61812-1	Emission Enclosure:	EN55011 Group 1 class A	Emission AC mains:	EN55011 Group 1 class A	(EMS)	EN61812-1	Immunity ESD:	IEC61000-4-2	Immunity RF-interference:	IEC61000-4-3	Immunity Burst:	IEC61000-4-4	Immunity Surge:	IEC61000-4-5	Immunity Conducted Disturbance:	IEC61000-4-6	Immunity Voltage Dip/Interruption:	IEC61000-4-11
(EMI)	EN61812-1																				
Emission Enclosure:	EN55011 Group 1 class A																				
Emission AC mains:	EN55011 Group 1 class A																				
(EMS)	EN61812-1																				
Immunity ESD:	IEC61000-4-2																				
Immunity RF-interference:	IEC61000-4-3																				
Immunity Burst:	IEC61000-4-4																				
Immunity Surge:	IEC61000-4-5																				
Immunity Conducted Disturbance:	IEC61000-4-6																				
Immunity Voltage Dip/Interruption:	IEC61000-4-11																				

**\*1.** The following safety standards apply to models with sockets (H5CX-A11□ or H5CX-L8□).

cUL (Listing): Applicable when an OMRON P2CF (-E) Socket is used.

cUR (Recognition): Applicable when any other socket is used.

**\*2.** Excluding the H5CX-ASD-N/-A11SD-N/-L8SD-N.

## I/O Functions

For details, refer to the timing charts on **page 20 and page 29**.

<b>Inputs *1</b>	<b>Start signal</b>	Normally functions to start timing. In modes A-2 and A-3, disable timing. In mode S, starts and stops timing.
	<b>Reset</b>	<ul style="list-style-type: none"> <li>Resets present value. (In elapsed time mode, the present value returns to 0; in remaining time mode, the present value returns to the set value.)</li> <li>Count inputs are not accepted and control output turns OFF while reset input is ON.</li> <li>Reset indicator is lit while reset input is ON.</li> </ul>
	<b>Gate *2</b>	Disables timing. (If a reset occurs while the gate input is ON, a reset will be performed.)
<b>Outputs</b>	<b>Control output (OUT)</b>	Outputs take place according to designated operating mode when timer reaches corresponding set value.

**\*1.** The H5CX-L8E□ does not have an input.

**\*2.** The H5CX-L□ does not have a gate input.

## Response Delay Time When Resetting (Transistor Output)

The following table shows the delay from when the reset signal is input until the output is turned OFF.

(Reference value)

Minimum reset signal width	Output delay time
1 ms	0.8 to 1.2 ms
20 ms	15 to 25 ms



# H5CX-A□-N/-L□-N

## Connections

### Block Diagram

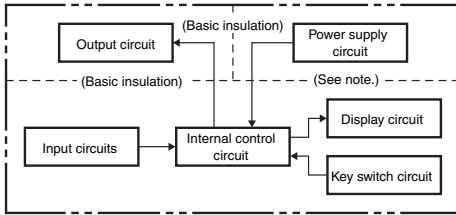

**Note:** Basic insulation is provided between the power supply circuit and the input circuits. However, basic insulation is not provided in the H5CX-□D-N.

### Terminal Arrangement

Confirm that the power supply meets specifications before use.

H5CX-A-N/-AD-N	H5CX-AS-N/-ASD-N
<p>Terminals 1 and 6 of the H5CX-AD-N are connected internally.</p>	<p>Terminals 1 and 6 of the H5CX-ASD-N are connected internally.</p>
H5CX-A11-N/-A11D-N	H5CX-A11S-N/-A11SD-N
<p>Terminals 2 and 3 of the H5CX-A11D-N are connected internally.</p>	<p>Terminals 2 and 3 of the H5CX-A11SD-N are connected internally.</p>
H5CX-L8-N/-L8D-N	H5CX-L8S-N/-L8SD-N
<p>Terminals 1 and 2 of the H5CX-L8D-N are connected internally.</p>	<p>Terminals 1 and 2 of the H5CX-L8SD-N are connected internally.</p>
H5CX-L8E-N/-L8ED-N	

**Note:** Do not connect unused terminals as relay terminals.

### Transistor Output

- The transistor output of the H5CX is insulated from the internal circuitry by a photocoupler, so the transistor output can be used as both NPN and PNP output.
- The diode connected to the collector of the output transistor is used to absorb inverted voltage that is generated when an inductive load is connected to the H5CX.

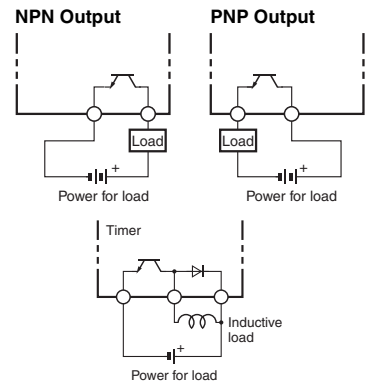

## Input Circuits

### Signal, Reset, and Gate Input

#### No-voltage Inputs (NPN Inputs)

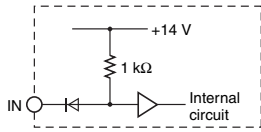

#### Voltage Inputs (PNP Inputs)

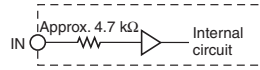

## Input Connections

The inputs are no-voltage (closed or open) inputs or voltage inputs except for the H5CX-L8□. (The inputs of the H5CX-L8□ are no-voltage inputs only. The H5CX-L8E□ does not have an input.)

### No-voltage Inputs (NPN Inputs)

#### Open Collector

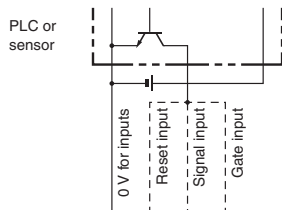

H5CX-A□	6	7	8	9
H5CX-A11□	3	7	6	5
H5CX-L8□	1	3	4	-

Note: Operate with transistor ON

#### Voltage Output

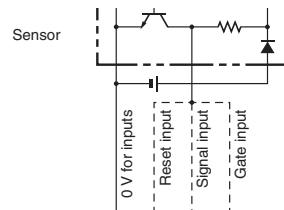

H5CX-A□	6	7	8	9
H5CX-A11□	3	7	6	5
H5CX-L8□	1	3	4	-

Note: Operate with transistor ON

#### Contact Input

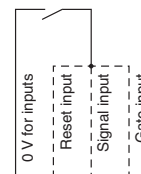

H5CX-A□	6	7	8	9
H5CX-A11□	3	7	6	5
H5CX-L8□	1	3	4	-

Note: Operate with relay ON

#### DC Two-wire Sensor

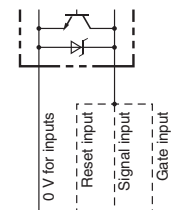

H5CX-A□	6	7	8	9
H5CX-A11□	3	7	6	5
H5CX-L8□	1	3	4	-

Note: Operate with transistor ON

### No-voltage Input Signal Levels

No-contact input	Short-circuit level Transistor ON
	<ul style="list-style-type: none"> <li>Residual voltage: 3 V max.</li> <li>Impedance when ON: 1 kΩ max.</li> </ul> (The leakage current is approx. 12 mA when the impedance is 0 Ω.)
Contact input	Open level Transistor OFF
	<ul style="list-style-type: none"> <li>Impedance when OFF: 100 kΩ min.</li> </ul> Use contacts which can adequately switch 5 mA at 10 V

Note: The DC voltage must be 30 VDC max.

#### Applicable Two-wire Sensor

- Leakage current: 1.5 mA max.
- Switching capacity: 5 mA min.
- Residual voltage: 3.0 VDC max.
- Operating voltage: 10 VDC

### Voltage Inputs (PNP Inputs) The inputs of the H5CX-L8□ are no-voltage inputs only.

#### No-contact Input (NPN Transistor)

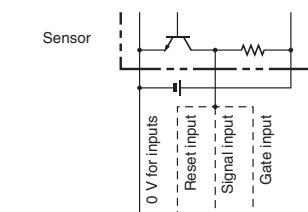

H5CX-A□	6	7	8	9
H5CX-A11□	3	7	6	5

Note: Operate with transistor OFF

#### No-contact Input (PNP Transistor)

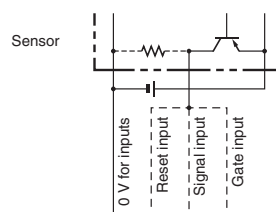

H5CX-A□	6	7	8	9
H5CX-A11□	3	7	6	5

Note: Operate with transistor ON

#### Contact Input

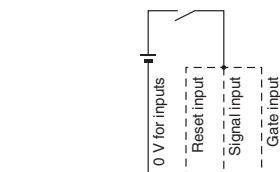

H5CX-A□	6	7	8	9
H5CX-A11□	3	7	6	5

Note: Operate with relay ON

### Voltage Input Signal Levels

High level (Input ON): 4.5 to 30 VDC

Low level (Input OFF): 0 to 2 VDC

- Note:
- The DC voltage must be 30 VDC max.
  - Input resistance: Approx. 4.7 kΩ

# H5CX-A□-N/-L□-N

## Nomenclature

### Display Section

1. Key Protect Indicator (orange)
2. Control Output Indicator (orange)
3. Reset Indicator (orange)
4. Present Value Display (Main display)  
(Character height: 12 mm, red \*)  
\* Characters on models with screw terminals (H5CX-A□) can be switched between red, green, and orange.
5. Time Unit Indicators  
(Color is same as present value display.)  
(If the time range is 0 min, 0 h, 0.0 h, or 0 h 0 min, these indicators flash to indicate timing operation.)
6. Set Value Display (Sub-display)  
(Character height: 6 mm, green)
7. Set Value 1, 2 Indicator (green)

Character Size  
for Present  
Value Display

Character Size  
for Set Value  
Display

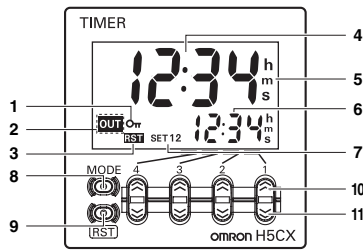
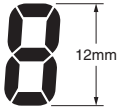

Front View

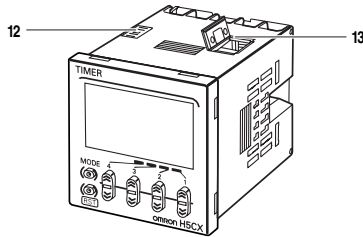

### Operation Key

8. Mode Key  
(Changes modes and setting items)
9. Reset Key  
(Resets present value and output)
10. Up Keys 1 to 4
11. Down Keys 1 to 4

### Switches

#### 12. Key-protect Switch

(Default setting) OFF (Disabled) ↔ ON (Enabled)

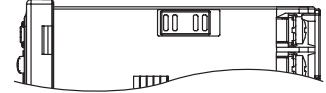

#### 13. DIP Switch

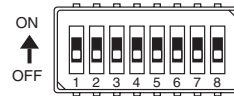

**Note:** There is no DIP switch on the H5CX-L8□.

## Dimensions

(unit: mm)

### Digital Timers

#### Digital Timers

#### H5CX-A-N/-AS-N (Flush Mounting Models)

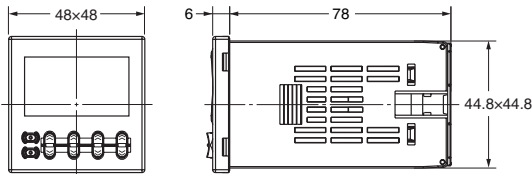
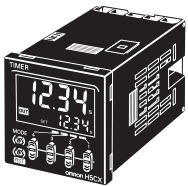

**Note:** M3.5 terminal screw (effective length: 6 mm)

#### H5CX-AD-N/-ASD-N (Flush Mounting Models)

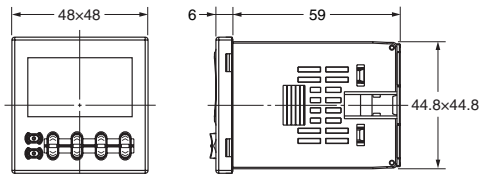
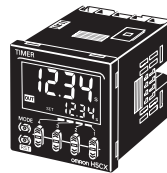

**Note:** M3.5 terminal screw (effective length: 6 mm)

#### H5CX-A11□-N

#### (Flush Mounting/Surface Mounting Models)

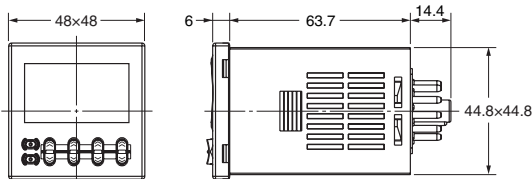

#### H5CX-L8□-N (Flush Mounting/Surface Mounting Models)

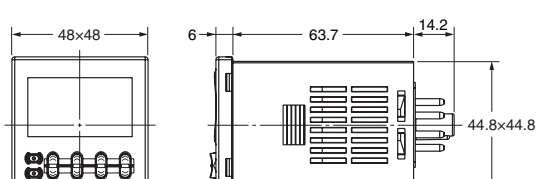

## Dimensions with Flush Mounting Adapter

### H5CX-A-N/-AS-N (Provided with Adapter and Waterproof Packing)

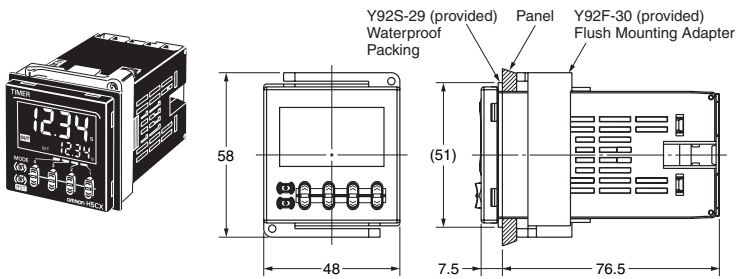

### Panel Cutouts

Panel cutouts areas shown below. (according to DIN43700).

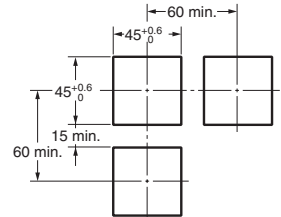

- Note:**
1. The mounting panel thickness should be 1 to 5 mm.
  2. To allow easier operation, it is recommended that Adapters be mounted so that the gap between sides with hooks is at least 15 mm (i.e., with the panel cutouts separated by at least 60 mm).
  3. It is possible to horizontally mount Timers side by side. Attach the Flush Mounting Adapters so that the surfaces without hooks are on the sides of the Timers. (However, if Timers are mounted side by side, water resistance will be lost.)

### H5CX-AD-N/-ASD-N (Provided with Adapter and Waterproof Packing)

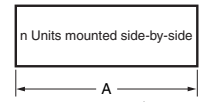
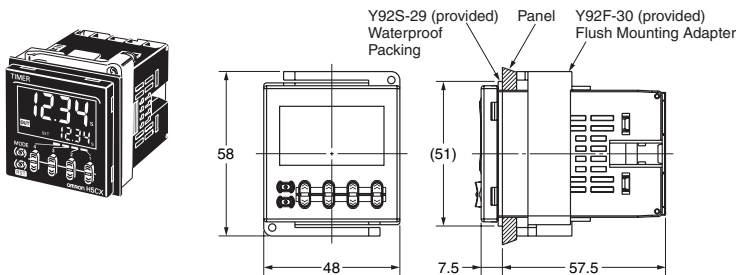

$$A = (48n - 2.5) \begin{matrix} +1 \\ -0 \end{matrix}$$

With Y92A-48F1 attached.

$$A = \{48n - 2.5 + (n-1) \times 4\} \begin{matrix} +1 \\ -0 \end{matrix}$$

With Y92A-48 attached.

$$A = (51n - 5.5) \begin{matrix} +1 \\ -0 \end{matrix}$$

### H5CX-A11□-N (Adapter and Waterproof Packing Ordered Separately)

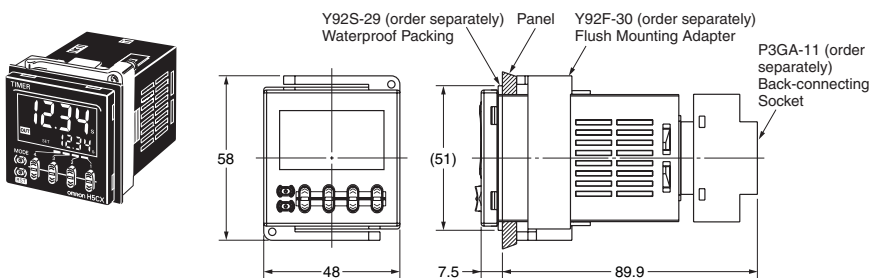

## Dimensions with Front Connecting Socket

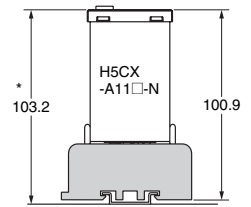

P2CF-11(-E) (order separately)  
Front Connecting Socket

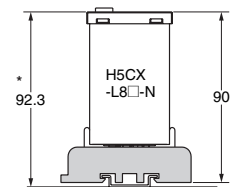

P2CF-08(-E) (order separately)  
Front Connecting Socket

\* These dimensions vary with the type of DIN track (reference value).

### H5CX-L8□-N (Adapter and Waterproof Packing Ordered Separately)

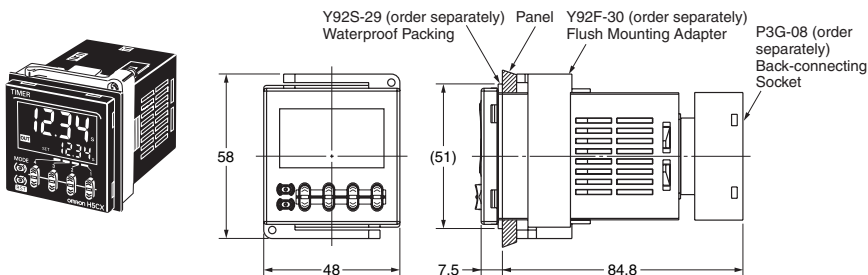

## Accessories (Order Separately)

**Note:**

Depending on the operating environment, the condition of resin products may deteriorate, and may shrink or become harder. Therefore, it is recommended that resin products are replaced regularly.

### Front Panel (Replacement Part)

You can change the color of the front panel when mounting the Timer. The Timer is shipped with a black (N1.5) Front Panel.

**Y92P-CXT4S**

Cover for Timer with 4 Digits  
White (5Y9.2/0.5)

**Y92P-CXT4G**

Cover for Timer with 4 Digits  
Light gray (5Y7/1)

**Y92P-CXT4B**

Cover for Timer with 4 Digits  
Black (N1.5)



### Replacement Method

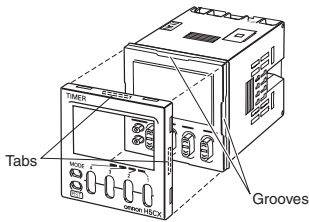

The Front Panel is attached to the Terminal with tabs in four locations. To remove the Front Panel, open the tabs and pull the Front Panel forward. To attach the Front Panel, press it onto the Timer so that all four tabs lodge into the grooves on the body of the Timer.

**Soft Cover  
Y92A-48F1**

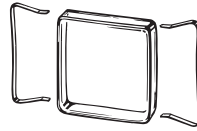

**Hard Cover  
Y92A-48**

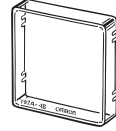

### Protecting the Timer in Environments Subject to Oil

The H5CX's panel surface is water-resistant (IP□6, UL Type 4X) and so even if drops of water penetrate the gaps between the keys, there will be no adverse effect on internal circuits. If, however, there is a possibility of oil being present on the operator's hands, use the Soft Cover. The Soft Cover ensures protection equivalent to IP54 against oil. Do not, however, use the H5CX in locations where it would come in direct contact with oil.

**Flush Mounting Adapter  
Y92F-30**

Order the Flush Mounting Adapter separately if it is lost or damaged.

**Note:** A Flush Mounting Adapter is included with models with screw terminals.

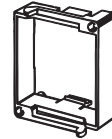

**Y92F-45**

Use this Adapter to install the Timer in a cutout previously made for a DIN 72 x 72 mm device (panel cutout: 68 x 68 mm).

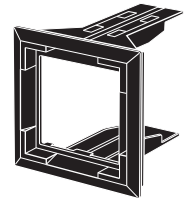

**Waterproof Packing  
Y92S-29**

**Note:** The Waterproof Packing is included with models with screw terminals.



Order the Waterproof Packing separately if it is lost or damaged. The Waterproof Packing can be used to achieve IP66 protection.

The Waterproof Packing will deteriorate, harden, and shrink depending on the application environment. To ensure maintaining the IP□6, UL Type 4X waterproof level, periodically replace the Waterproof Packing. The periodic replacement period will depend on the application environment. You must confirm the proper replacement period. Use 1 year or less as a guideline. If the Waterproof Packing is not replaced periodically, the waterproof level will not be maintained.

It is not necessary to mount the Waterproof Packing if waterproof construction is not required.

**Connection Sockets**  
**Front-connecting Sockets**

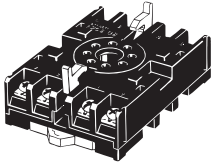
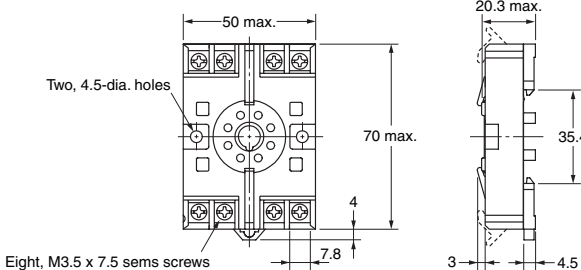
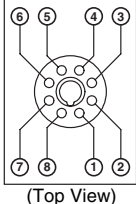
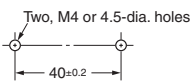
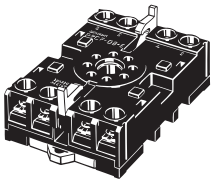
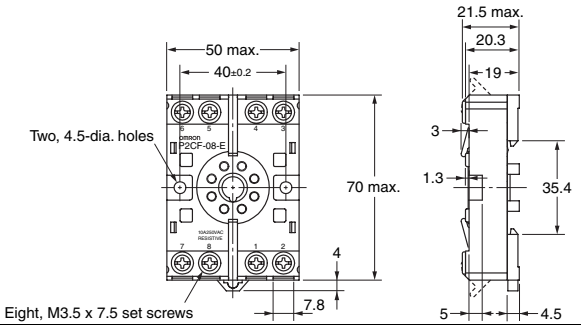
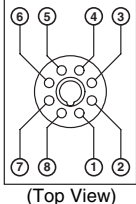
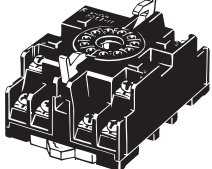
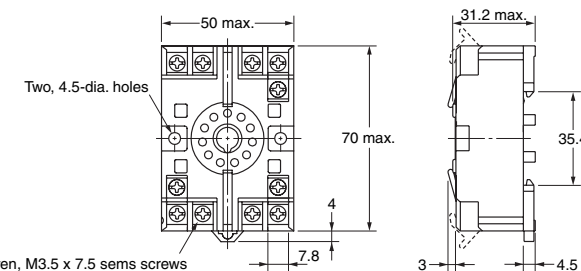
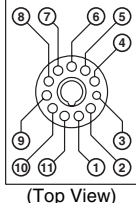
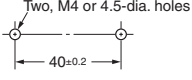
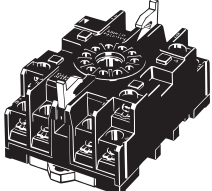
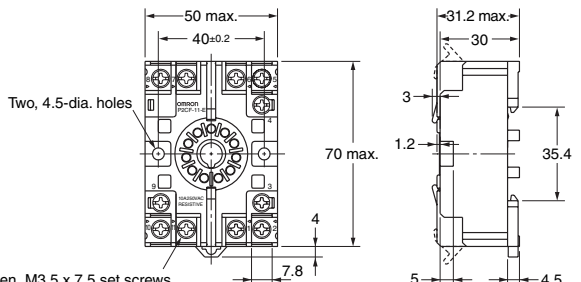
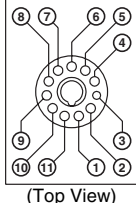
Model	Dimensions	Terminal arrangement and internal connections	Mounting hole dimensions
 <b>P2CF-08</b>		 <p>(Top View)</p>	 <p>Two, M4 or 4.5-dia. holes 40±0.2</p>
 <b>P2CF-08-E (Finger Safe Terminal)</b>		 <p>(Top View)</p>	<p><b>Note:</b> The Socket can also be mounted to DIN track.</p>
 <b>P2CF-11</b>		 <p>(Top View)</p>	 <p>Two, M4 or 4.5-dia. holes 40±0.2</p>
 <b>P2CF-11-E (Finger Safe Terminal Type)</b>		 <p>(Top View)</p>	<p><b>Note:</b> The Socket can also be mounted to DIN track.</p>

**Note:** Round crimp terminals cannot be used on Finger-safe Sockets. Use forked crimp terminals.

**Back-connecting Sockets**

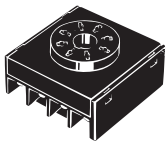
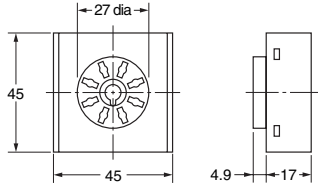
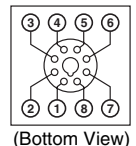
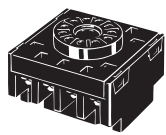
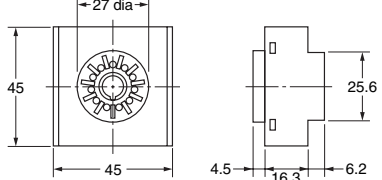
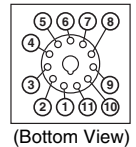
Model	Dimensions	Terminal arrangement and internal connections
 <b>P3G-08</b>		 <p>(Bottom View)</p>
 <b>P3GA-11</b>		 <p>(Bottom View)</p>

**Note:** A Y92A-48G Terminal Cover can be used with the Socket to create a finger-safe construction.

# H5CX-A□-N/-L□-N

## Terminal Covers for P3G-08 and P3GA-11 Back-connecting Sockets

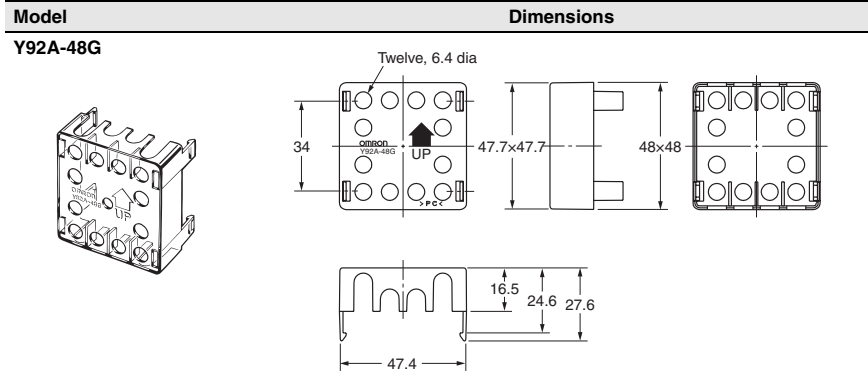

**Note:** The Terminal Cover can be used with a Back-mounting Socket (P3G-08 or P3GA-11) to create a finger-safe construction.

## Optional Products for Track Mounting

### Mounting Track

PFP-100N  
PFP-50N

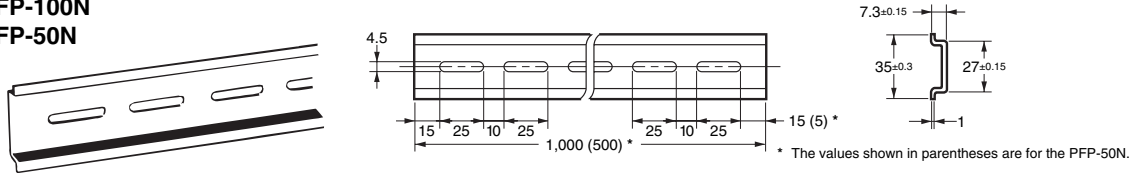

### Mounting Track

PFP-100N2

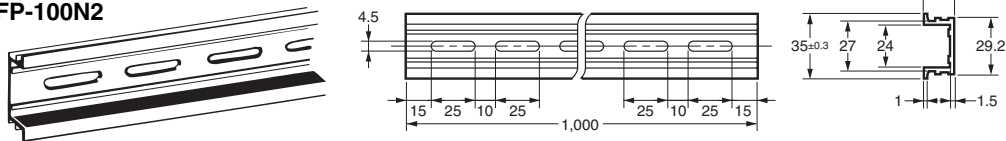

### End Plate

PFP-M

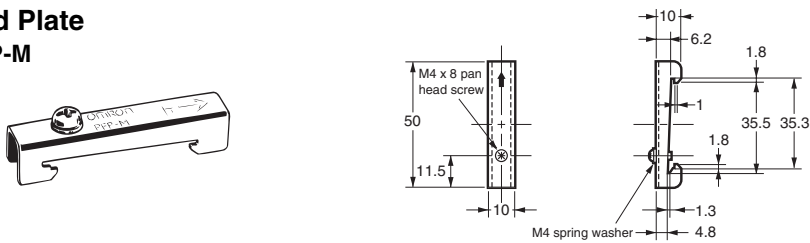

### Spacer

PFP-S

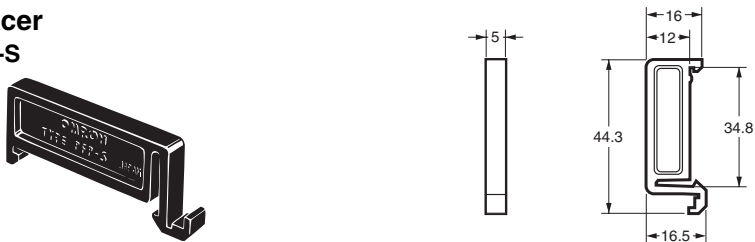

**Note:** Order Spacers in increments of 10.

## Operating Procedures

### Setting Procedure Guide

#### Settings for Timer Operation \*

Use the following settings.

#### Settings for Twin Timer Operation \*

Refer to **page 25**.

\* It is not necessary to mount the Waterproof Packing if waterproof construction is not required.

### Operating Procedures for Timer Function

**Step1** Settings for basic functions can be performed with just the DIP switch.

**Note:** There is no DIP switch on the H5CX-L8□. Go to **Step2**.

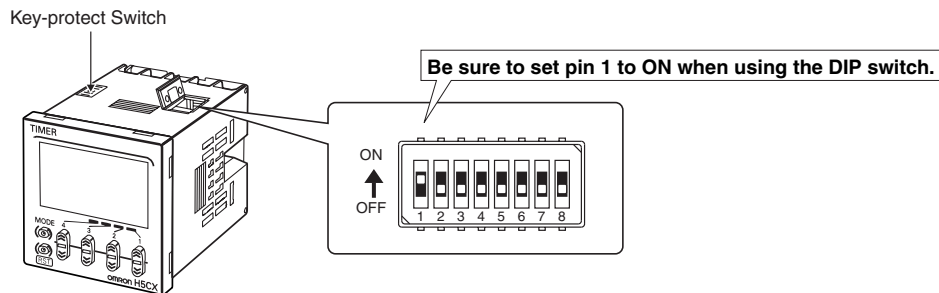

	Item	OFF	ON
1	DIP switch settings	Disabled	Enabled
2	Time range	Refer to the table on the right.	
3			
4	Output modes	Refer to the table on the right.	
5			
6	Timer mode	UP	DOWN
7	Input signal width	20 ms	1 ms
8			

Pin 2	Pin 3	Pin 4	Time range
ON	ON	ON	0.001 s to 9.999 s
OFF	OFF	OFF	0.01 s to 99.99 s
ON	OFF	OFF	0.1 s to 999.9 s
OFF	ON	OFF	1 s to 9999 s
ON	ON	OFF	0 min 01 s to 99 min 59 s
OFF	OFF	ON	0.1 min to 999.9 min
ON	OFF	ON	0 h 01 min to 99 h 59 min
OFF	ON	ON	0.1 h to 999.9 h

**Note:** All the pins are factory-set to OFF.

- Be sure to turn ON pin 1 of the DIP switch.
- Changes to DIP switch settings are enabled when the power is turned ON.  
(Set the DIP switch while the power is OFF.)

Pin 5	Pin 6	Output mode
OFF	OFF	Mode A: Signal ON delay 1 (Timer resets when power comes ON.)
ON	OFF	Mode A-2: Power ON delay 1 (Timer resets when power comes ON.)
OFF	ON	Mode E: Interval (Timer resets when power comes ON.)
ON	ON	Mode F: Cumulative (Timer does not reset when power comes ON.)

After making DIP switch settings for basic operation, advanced functions can be added using the operation keys on the front panel. Refer to **Step2** on **page 16** for details.



## Step2 Settings that cannot be performed with the DIP switch are performed with the operation keys.

- Change to Function Setting Mode.

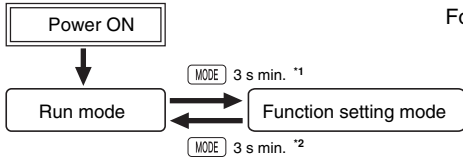

For details on operations in run mode, refer to **page 19**.

- \*1. If the mode is switched to the function setting mode during operation, operation will continue.
- \*2. Changes made to settings in function setting mode are enabled for the first time when the mode is changed to run mode. Also, when settings are changed, the timer is reset (time initialized and output turned OFF).

The characters displayed in reverse video are the default settings.  
When performing settings with operation keys only, set pin 1 of the DIP switch to OFF (factory setting).  
If pin 1 of the DIP switch is set to ON, the setting items indicated in    will not be displayed.

Function setting mode

- Set the time range using the keys.  
  
 → For details, refer to the **Time Range List**.
- Set the timer mode using the keys.
- Set the output mode using the keys.  
  
**Note:** Only modes **A-2**, b, E, and Z can be selected for models with instantaneous contact outputs.
- Set each digit for the output time using the corresponding keys.  
  
 (Output hold) (0.01s) (99.99s)  
 (If the output time is set to 0.00, **Hold** is displayed.)  
**Note:** Displayed for modes A, A-1, A-2, A-3, b, b-1 and S only.
- Set the input signal width using the keys.  
  
 (20ms) (1ms)  
**Note:** Not displayed for models with instantaneous contact outputs.
- Set the NPN/PNP mode using the keys.  
  
 (NPN input) (PNP input)  
**Note:** Only displayed for the H5CX-A□ and H5CX-A11□.
- Set the display color using the keys.  
  
 (Red) (Green) (Orange) (Red-green) (Green-red) (Red-orange) (Orange-red) (Green-orange) (Orange-green)  
**Note:** Displayed only for models with terminal screws (H5CX-A□).
- Set the function (instantaneous or time-limit operation) for the instantaneous output (output 1) using the Keys.  
  
 (Instantaneous) (Time-limit)  
**Note:** Displayed only for models with instantaneous contact outputs.

Time Range List	
Display	Set Value
	0.01 s to 99.99 s (default setting)
	0.1 s to 999.9 s
	1 s to 9999 s
	0 min 01 s to 99 min 59 s
	0.1 min to 999.9 min
	1 min to 9999 min
	0 h 01 min to 99 h 59 min
	0.1 h to 999.9 h
	1 h to 9999 h
	0.001 s to 9.999 s

From next page To next page



# H5CX-A□-N/-L□-N Timer

## Explanation of Functions

### Operating Procedures for Timer Function

Items marked with stars (★) can be set using the DIP switch.

#### Time Range (t<sub>min</sub>-t<sub>max</sub>)★

Set the range to be timed in the range 0.001 s to 9,999 h. Settings of type ---- h (9,999 h) and ---- min (9,999 min) cannot be made with the DIP switch. Use the operation keys if these settings are required.

#### Timer Mode (t<sub>min</sub>-t<sub>max</sub>)★

Set either the elapsed time (UP) or remaining time (DOWN) mode. In UP mode, the elapsed time is displayed, and in DOWN mode, the remaining time is displayed.

#### Output Mode (o<sub>min</sub>-o<sub>max</sub>)★

Set the output mode. The possible settings are A, A-1, A-2, A-3, b, b-1, d, E, F, Z and S. Only output modes A, A-2, E, and F can be set using the DIP switch. Use the operation keys if a different setting is required. (For details on output mode operation, refer to "Timing Charts" on page 20.)

#### Output Time (o<sub>min</sub>-t<sub>max</sub>)

When using one-shot output, set the output time for one-shot output (0.01 to 99.99 s). One-shot output can be used only if the selected output mode is A, A-1, A-2, A-3, b, b-1 or S. If the output time is set to 0.00, H<sub>0</sub>L<sub>0</sub> is displayed, and the output is held.

#### Input Signal Width (i<sub>min</sub>-i<sub>max</sub>)★

Set the minimum signal input width (20 ms or 1 ms) for signal, reset, and gate inputs. The same setting is used for all external inputs (signal, reset, and gate inputs). If contacts are used for the input signal, set the input signal width to 20 ms. Processing to eliminate chattering is performed for this setting.

#### NPN/PNP Input Mode (i<sub>min</sub>-i<sub>max</sub>)

Select either NPN input (no-voltage input) or PNP input (voltage input) as the input format. Set an NPN input when using a 2-wire sensor. For details on input connections, refer to "Input Connections" on page 9.

#### Display Color (c<sub>min</sub>-c<sub>max</sub>)

(Terminal block model: H5CX-A□ only)

Set the color used for the present value.

	Output OFF	Output ON
r <sub>0</sub> E <sub>0</sub> d	Red (fixed)	
g <sub>0</sub> r <sub>0</sub> n	Green (fixed)	
o <sub>0</sub> r <sub>0</sub> g	Orange (fixed)	
r <sub>0</sub> -g	Red	Green
g <sub>0</sub> -r	Green	Red
r <sub>0</sub> -o	Red	Orange
o <sub>0</sub> -r	Orange	Red
g <sub>0</sub> -o	Green	Orange
o <sub>0</sub> -g	Orange	Green

#### Key Protect Level (k<sub>min</sub>-k<sub>max</sub>)

Set the key protect level. Refer to "Key Protect Level" on page 32.

#### Instantaneous/Time-limit (o<sub>min</sub>-t<sub>max</sub>)

Set the contact output to time-limit SPDT + instantaneous SPDT or time-limit SPDT operation.

#### Set Value Upper Limit (s<sub>min</sub>-s<sub>max</sub>)

Set the upper limit for the set value when it is set in Run Mode. The limit can be set to between 1 and 9999. This setting does not apply to the ON duty in Z mode.

#### Output ON Count Alarm Set Value (o<sub>min</sub>-A)

Set the alarm value for the output ON count. The limit can be set to between 0 x 1000 (0 times) and 9999 x 1000 (9,999,000 times). Only the underlined values are set. The alarm will be disabled if 0 is set. If the total ON count of the output exceeds the alarm set value, E<sub>3</sub> will be displayed on the Timer to indicate that the output ON count alarm value was exceeded. Refer to "Self-diagnostic Function" on page 32 for information on the E<sub>3</sub> display.

#### ON Count Alarm Set Values for Outputs 1 and 2 (OUT1 and OUT2) (o<sub>min</sub>-A<sub>1</sub> and o<sub>min</sub>-A<sub>2</sub>)

Set the ON count alarm values for the outputs 1 and 2. The limit can be set to between 0 x 1000 (0 times) and 9999 x 1000 (9,999,000 times). Only the underlined values are set. The alarm will be disabled if 0 is set. If the total ON count of instantaneous output 1 or 2 exceeds the alarm set value, E<sub>3</sub> will be displayed on the Timer to indicate that the output ON count alarm value was exceeded. Refer to "Self-diagnostic Function" on page 32 for information on the E<sub>3</sub> display.

#### Output ON Count Monitor Value (o<sub>min</sub>-M)

The monitor value is only displayed. It cannot be set. The output ON count will be 1,000 times the displayed value.

#### ON Count Monitor Values for Outputs 1 and 2 (OUT1 and OUT2) (o<sub>min</sub>-M<sub>1</sub> and o<sub>min</sub>-M<sub>2</sub>)

The monitor value for output 1 or 2 is only displayed. It cannot be set. The output ON count will be 1,000 times the displayed value.

## Operation in Run Mode Operating Procedures for Timer Function

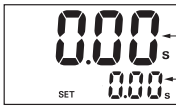

Present value

Set value

- Set each digit for the output time using the corresponding  $\triangleleft$   $\triangleright$  keys.



**Note: H5CX-L8E□-N Precautions**  
Set the Timer's set value before using the Timer in a self-holding circuit.

▪ When Output Mode Z Is Selected





Present value

ON duty ratio

- Set each digit for the output time using the corresponding  $\triangleleft$   $\triangleright$  keys. (The  $\triangleleft$   $\triangleright$  keys for the 4th digit cannot be used.)

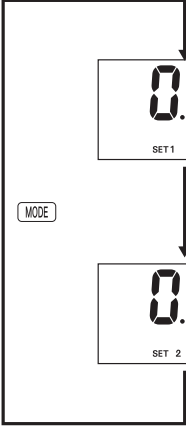





Present value

Cycle time

- Set each digit for the output time using the corresponding  $\triangleleft$   $\triangleright$  keys.



### Present Value and Set Value

These items are displayed when the power is turned ON. The present value is displayed in the main display and the set value is displayed in the sub-display.  
The values displayed will be determined by the settings made for the time range and the timer mode in function setting mode.

### Present Value and ON Duty Ratio (Output Mode = Z)

The present value is displayed in the main display and the ON duty ratio is displayed in the sub-display. Set the ON duty ratio used in ON/OFF-duty-adjustable flicker mode (Z) as a percentage.

$$\text{ON time} = \text{Cycle time} \times \frac{\text{ON duty ratio (\%)}}{100}$$

The output accuracy will vary with the time range, even if the ON duty ratio setting is the same. Therefore, if fine output time adjustment is required, it is recommended that the time range for the cycle time is set as small as possible.

**Examples:** 1. When Time Range = - - - - s (9999 s)

$$20(\text{s}) \times \frac{31(\%)}{100} = 6.2(\text{s})$$

Rounded off to the nearest integer (because of the time range setting) → ON time = 6 s

2. When Time Range = - - . - - s (99.99 s)

$$20.00(\text{s}) \times \frac{31(\%)}{100} = 6.200(\text{s})$$

Rounded off to 2 decimal places (because of the time range setting) → ON time = 6.20 s

If a cycle time is set, cyclic control can be performed in ON/OFF-duty-adjustable flicker mode simply by changing the ON duty ratio.

### Present Value and Cycle Time (Output Mode = Z)

The present value is displayed in the main display and the cycle time is displayed in the sub-display. Set the cycle time.

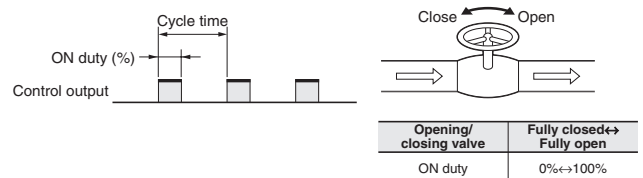
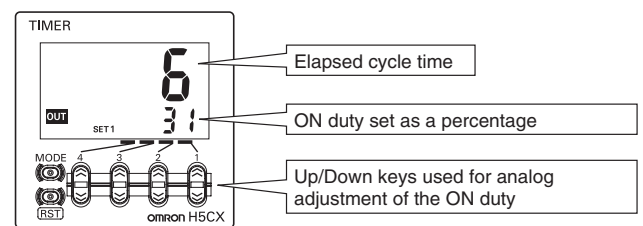

# H5CX-A□-N/-L□-N Timer

## Timing Charts Operating Procedures for Timer Function Models without Instantaneous Contact Outputs

The gate input is not included in the H5CX-L8□ models.

 Either one-shot output or sustained output can be selected.

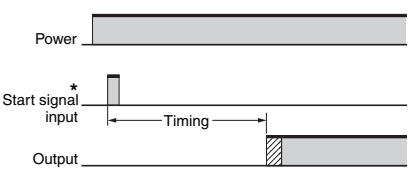
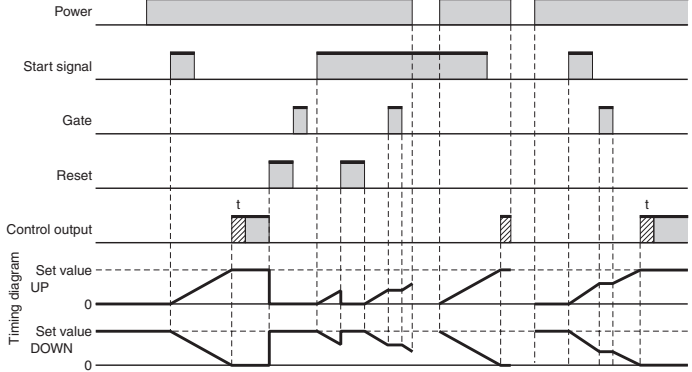
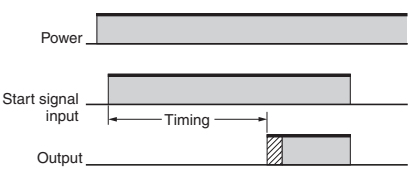
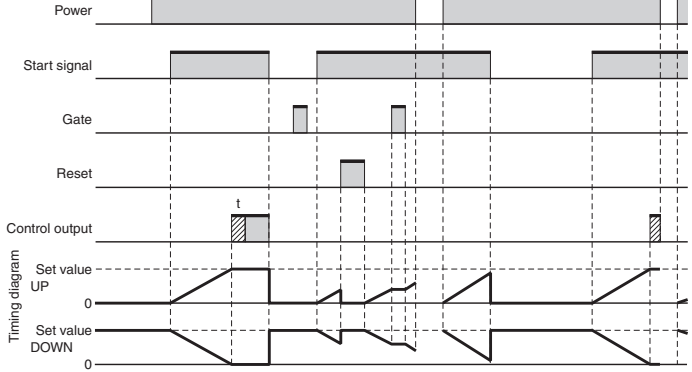
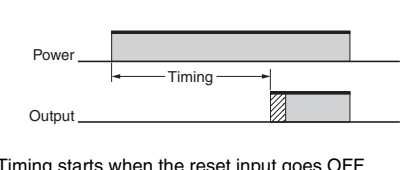
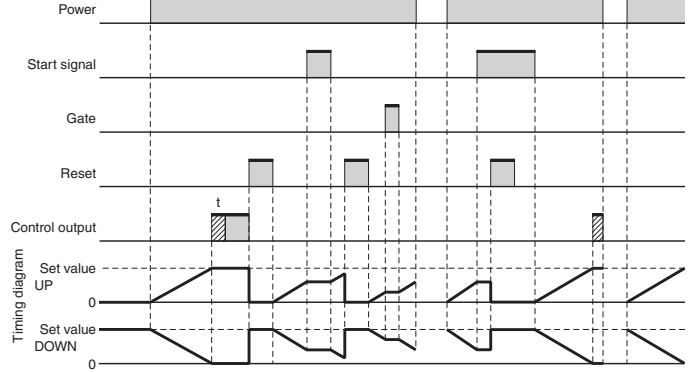
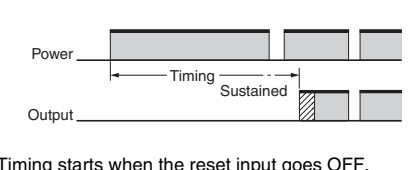
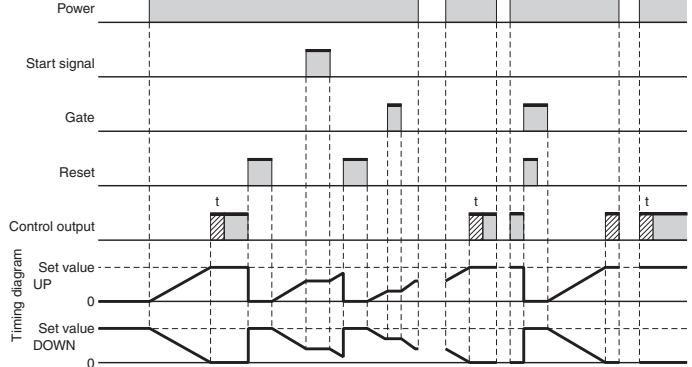
Mode A: Signal ON delay 1 (Timer resets when power comes ON.)	
Basic operation	Detailed operation
 <p>* Start signal input is disabled during timing.</p> <p>Timing starts when the start signal goes ON. While the start signal is ON, the timer starts when the power comes ON or when the reset input goes OFF. The control output is controlled using a sustained or one-shot time period.</p> <p><b>Note:</b> Output is instantaneous when setting is 0.</p>	
Mode A-1: Signal ON delay 2 (Timer resets when power comes ON.)	
Basic operation	Detailed operation
 <p>Timing starts when the start signal goes ON, and resets when the start signal goes OFF. While the start signal is ON, the timer starts when the power comes ON or when the reset input goes OFF. The control output is controlled using a sustained or one-shot time period.</p> <p><b>Note:</b> Output is instantaneous when setting is 0.</p>	
Mode A-2: Power ON delay 1 (Timer resets when power comes ON.)	
Basic operation	Detailed operation
 <p>Timing starts when the reset input goes OFF. The start signal disables the timing function (i.e., same function as the gate input). The control output is controlled using a sustained or one-shot time period.</p> <p><b>Note:</b> Output is instantaneous when setting is 0.</p>	
Mode A-3: Power ON delay 2 (Timer does not reset when power comes ON.)	
Basic operation	Detailed operation
 <p>Timing starts when the reset input goes OFF. The start signal disables the timing function (i.e., same function as the gate input). The control output is controlled using a sustained or one-shot time period.</p> <p><b>Note:</b> Output is instantaneous when setting is 0.</p>	

## Mode b: Repeat cycle 1 (Timer resets when power comes ON.)

### Basic operation

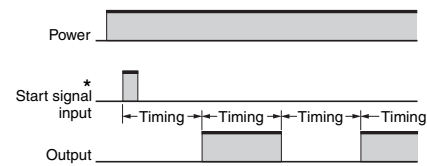

\* Start signal input is disabled during timing.

Timing starts when the start signal goes ON.  
The status of the control output is reversed when time is up (OFF at start).

While the start signal is ON, the timer starts when the power comes ON or when the reset input goes OFF.

**Note:** Normal output operation will not be possible if the set time is too short.  
Set the value to at least 100 ms (contact output type).

### Detailed operation

#### Sustained Output

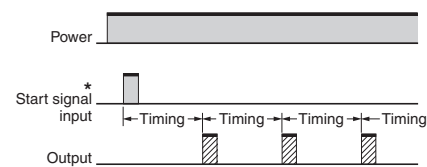
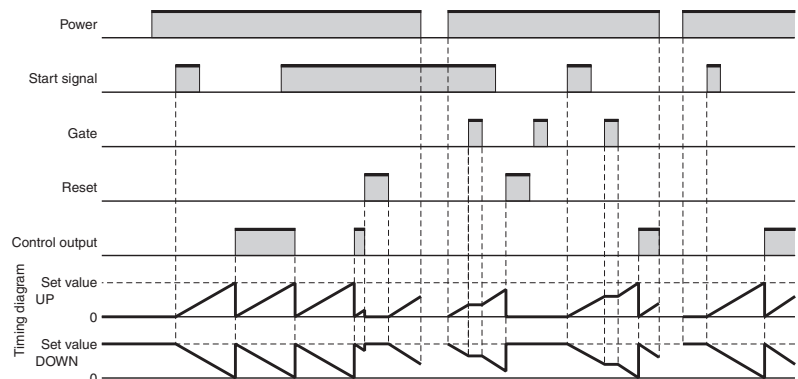

\* Start signal input is disabled during timing.

Timing starts when the start signal goes ON.  
The control output is turned ON when time is up.  
While the start signal is ON, the timer starts when the power comes ON or when the reset input goes OFF.

**Note:** Normal output operation will not be possible if the set time is too short.  
Set the value to at least 100 ms (contact output type).

#### One-shot Output

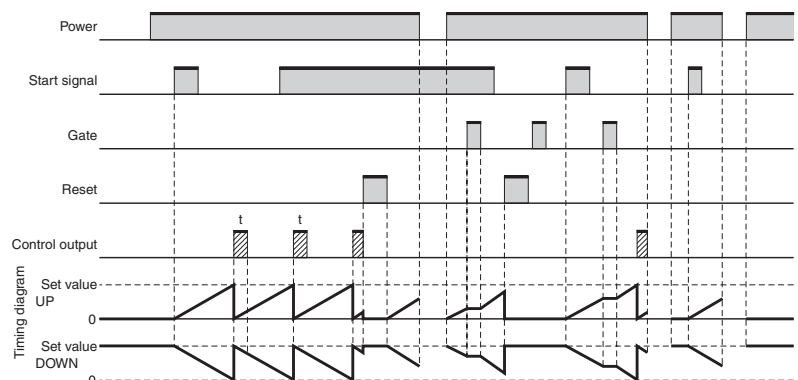

## Mode b-1: Repeat cycle 2 (Timer does not reset when power comes ON.)

### Basic operation

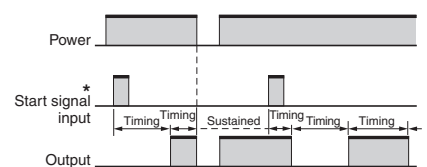

\* Start signal input is disabled during timing.

Timing starts when the start signal goes ON.  
The status of the control output is reversed when time is up (OFF at start).

While the start signal is ON, the timer starts when the power comes ON or when the reset input goes OFF.

**Note:** Normal output operation will not be possible if the set time is too short.  
Set the value to at least 100 ms (contact output type).

### Detailed operation

#### Sustained Output

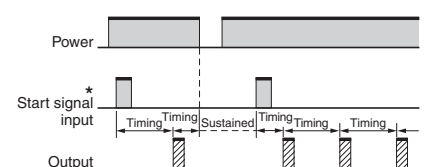
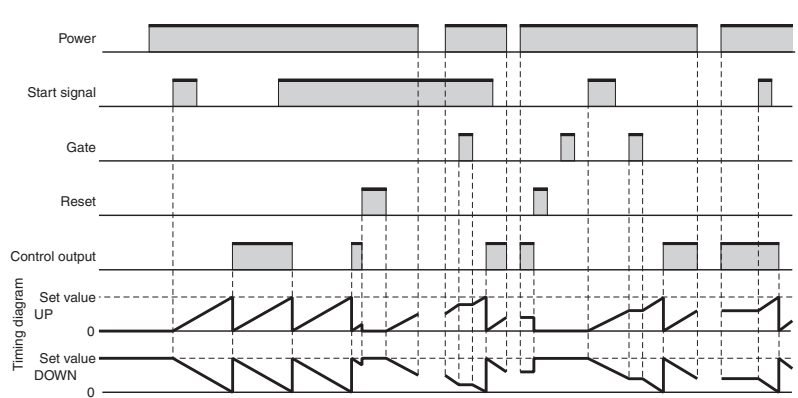

\* Start signal input is disabled during timing.

Timing starts when the start signal goes ON.  
The control output is turned ON when time is up.  
While the start signal is ON, the timer starts when the power comes ON or when the reset input goes OFF.

**Note:** Normal output operation will not be possible if the set time is too short.  
Set the value to at least 100 ms (contact output type).

#### One-shot Output

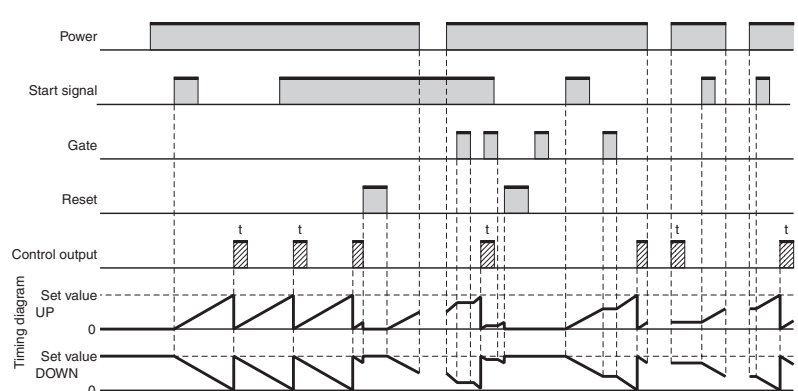

# H5CX-A□-N/-L□-N Timer

## Mode d: Signal OFF delay (Timer resets when power comes ON.)

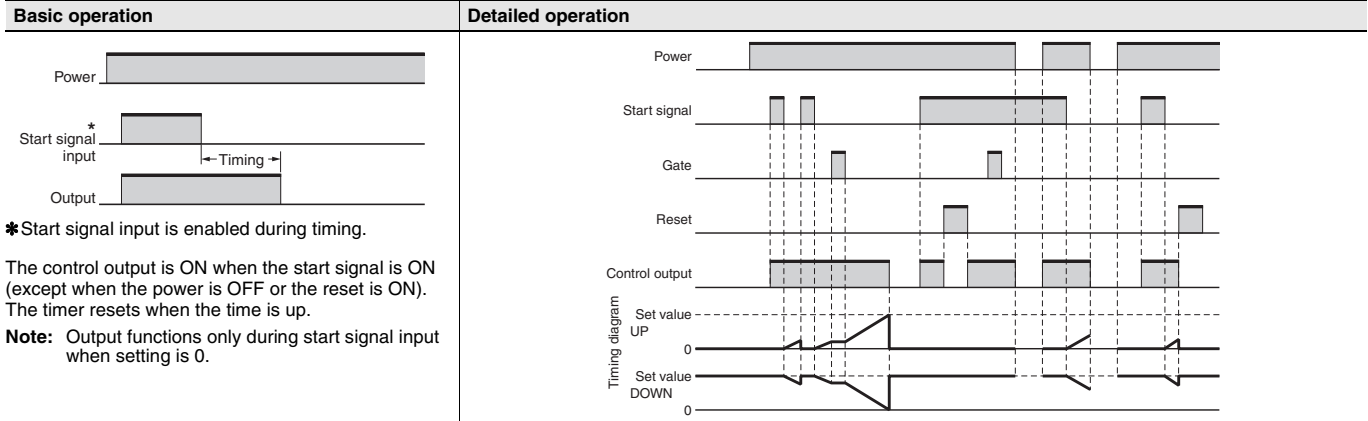

## Mode E: Interval (Timer resets when power comes ON.)

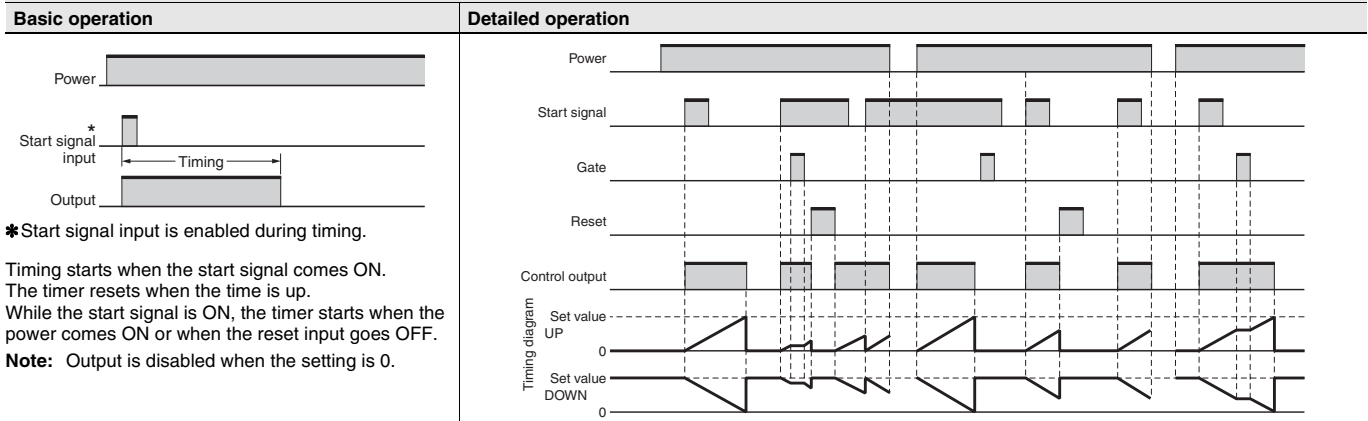

## Mode F: Cumulative (Timer does not reset when power comes ON.)

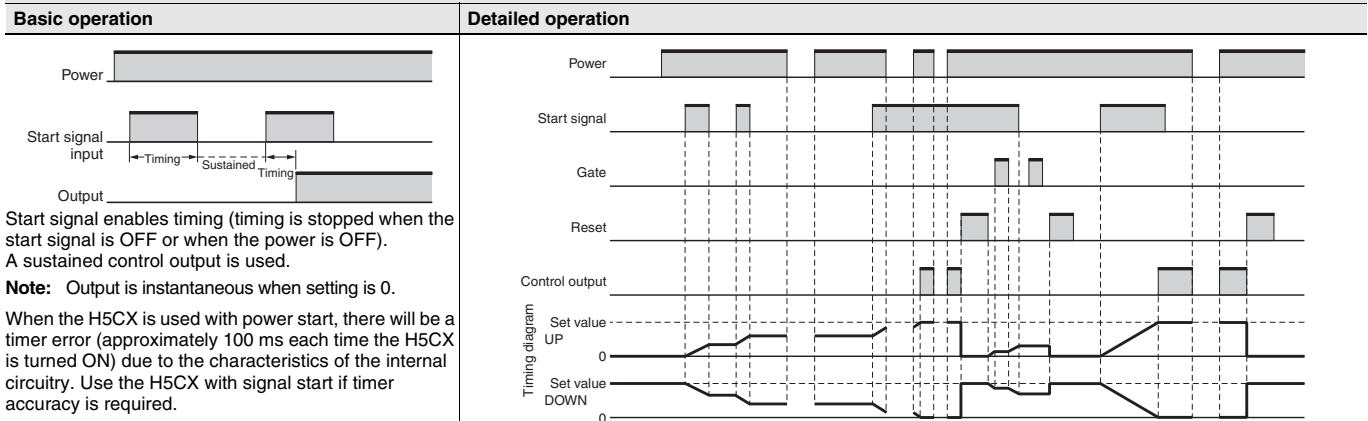

## Mode Z: ON/OFF-duty-adjustable flicker (Timer resets when power comes ON.)

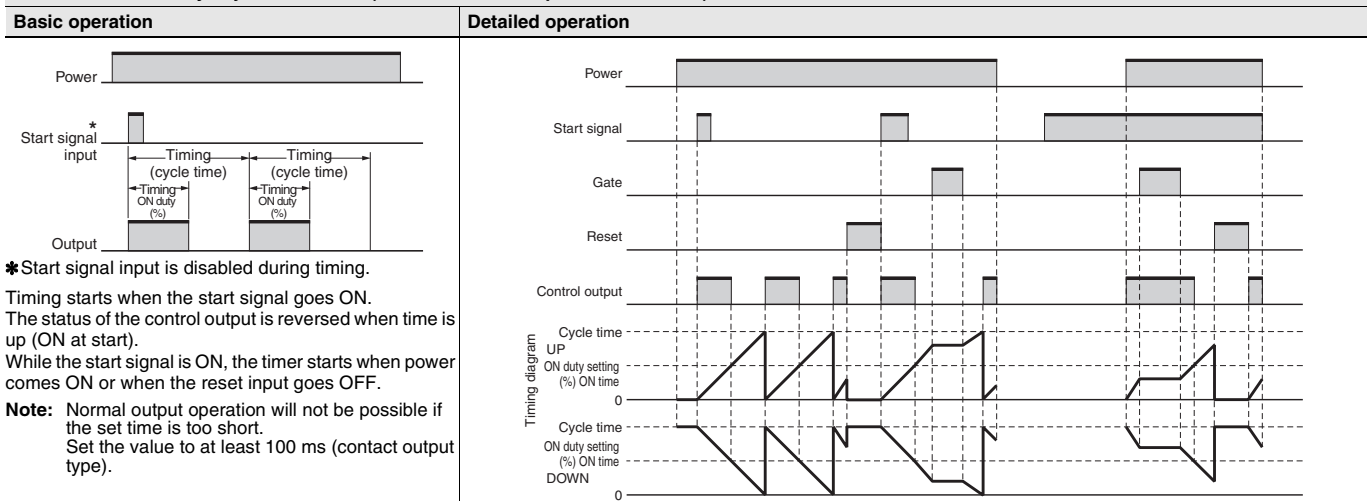

## Mode S: Stopwatch (Timer resets when power comes ON.)

### Basic operation

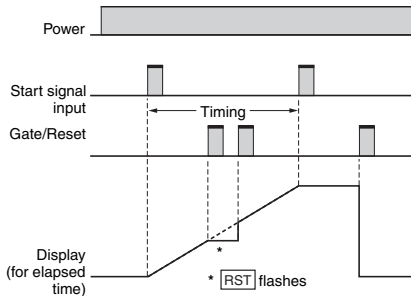

The signal starts and stops timing.  
The display is held and timing is continued if the reset or gate input is received during timing operation.  
The timer resets if the reset or gate input is received when the timing operation is stopped.

**Note:** Output is instantaneous when setting is 0.

### Detailed operation

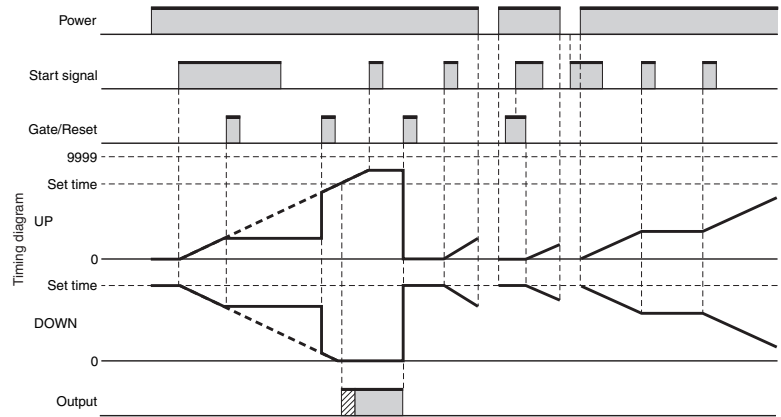

## Models with Instantaneous Contact Outputs

Either one-shot output or sustained output can be selected.

## Mode A-2: Power ON delay (Timer resets when power comes ON.)

### Basic operation

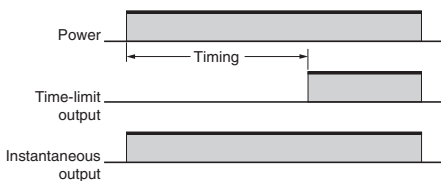

The Timer starts when the power comes ON or when the reset input goes OFF.

**Note:** Output is instantaneous when setting is 0.

### Detailed operation

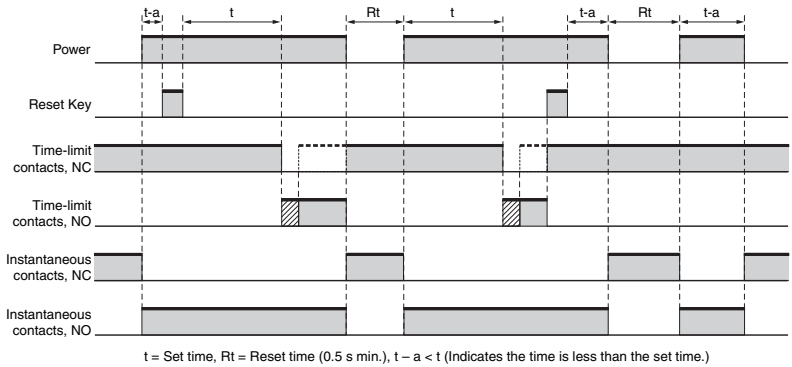

## Mode b: Repeat cycle 1 (Timer resets when power comes ON.)

### Basic operation

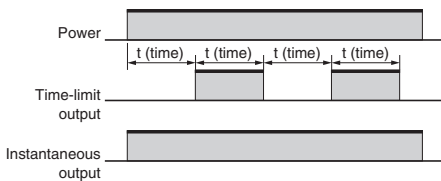

The Timer starts when the power comes ON or when the reset input goes OFF.

**Note:** Normal output operation will not be possible if the set time is too short.  
Set the value to at least 100 ms.

### Detailed operation

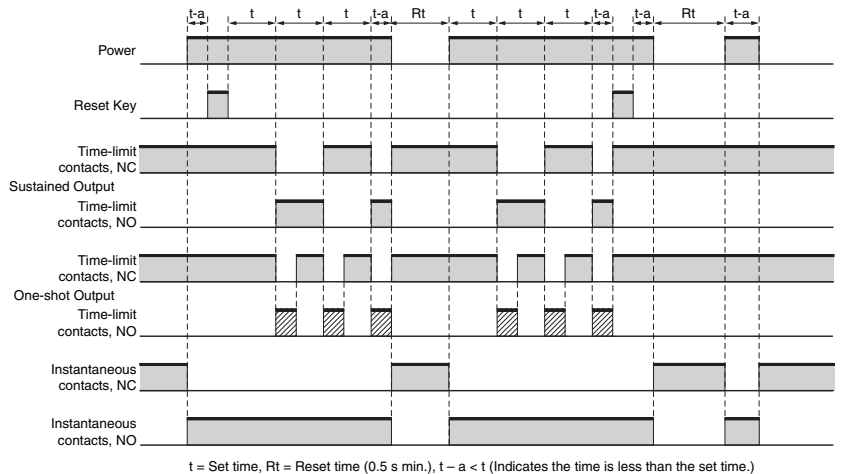

### **Note:** H5CX-L8E□-N Precautions

Set the Timer's set value before using the Timer in a self-holding circuit.



# H5CX-A□-N/-L□-N Timer

## Mode E: Interval (Timer resets when power comes ON.)

### Basic operation

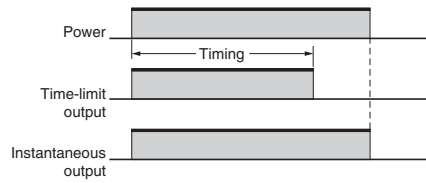

The Timer starts when the power comes ON or when the reset input goes OFF.

**Note:** Output is not instantaneous when setting is 0.

### Detailed operation

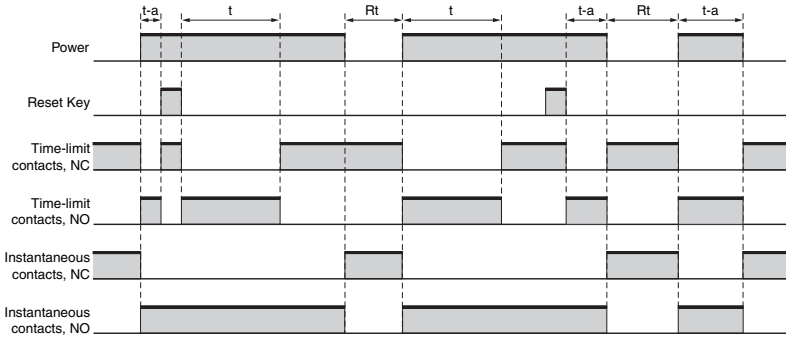

$t$  = Set time,  $Rt$  = Reset time (0.5 s min.),  $t - a < t$  (Indicates the time is less than the set time.)

## Mode Z: ON/OFF-duty adjustable flicker (Timer resets when power comes ON.)

### Basic operation

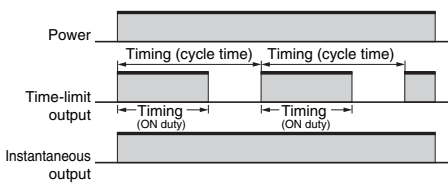

The Timer starts when the power comes ON or when the reset input goes OFF.

**Note:** Normal output operation will not be possible if the set time is too short.  
Set the value to at least 100 ms.

### Detailed operation

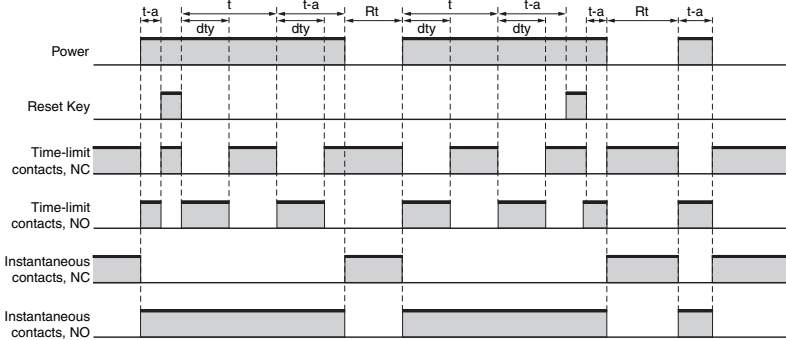

$t$  = Set time,  $dty$  = ON duty time,  $Rt$  = Reset time (0.5 s min.),  $t - a < t$  (Indicates the time is less than the set time.)

### Note: H5CX-L8E□-N Precautions

Set the Timer's set value before using the Timer in a self-holding circuit.

## Setting Procedure Guide

### Operating Procedures for Twin Timer Function

#### Step1 Switching to a Twin Timer

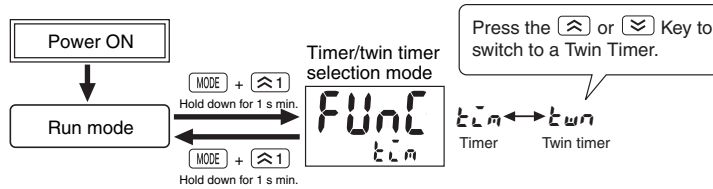

#### Step2 Settings for basic functions can be performed with just the DIP switch.

**Note:** There is no DIP switch on the H5CX-L8□. Go to **Step3**.

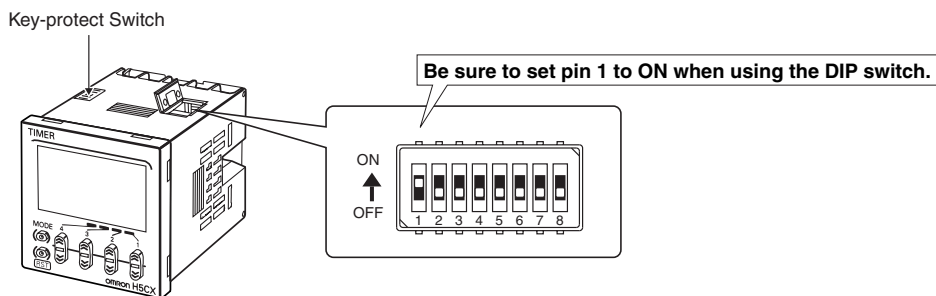

	Item	OFF	ON
1	DIP switch settings	Disabled	Enabled
2	OFF time range	Refer to the table on the right.	
3			
4	ON time range	Refer to the table on the right.	
5			
6	Output mode	Flicker OFF start	Flicker ON start
7	Timer mode	UP	DOWN
8	Input signal width	20 ms	1 ms

Pin 2	Pin 3	OFF time range
OFF	OFF	0.01 s to 99.99 s
ON	OFF	0.1 s to 999.9 s
OFF	ON	1 s to 9999 s
ON	ON	0 min 01 s to 99 min 59 s

Pin 4	Pin 5	ON time range
OFF	OFF	0.01 s to 99.99 s
ON	OFF	0.1 s to 999.9 s
OFF	ON	1 s to 9999 s
ON	ON	0 min 01 s to 99 min 59 s

**Note:** All the pins are factory-set to OFF.

- Be sure to turn ON pin 1 on the DIP switch.
- Changes to DIP switch settings are enabled when the power is turned ON. (Perform DIP switch settings while the power is OFF.)

After making DIP switch settings for basic operation, advanced functions can be added using the operation keys on the front panel. Refer to **Step3** on page 26 for details.