



Chipsmall Limited consists of a professional team with an average of over 10 year of expertise in the distribution of electronic components. Based in Hongkong, we have already established firm and mutual-benefit business relationships with customers from,Europe,America and south Asia,supplying obsolete and hard-to-find components to meet their specific needs.

With the principle of “Quality Parts,Customers Priority,Honest Operation,and Considerate Service”,our business mainly focus on the distribution of electronic components. Line cards we deal with include Microchip,ALPS,ROHM,Xilinx,Pulse,ON,Everlight and Freescale. Main products comprise IC,Modules,Potentiometer,IC Socket,Relay,Connector.Our parts cover such applications as commercial,industrial, and automotives areas.

We are looking forward to setting up business relationship with you and hope to provide you with the best service and solution. Let us make a better world for our industry!



Contact us

Tel: +86-755-8981 8866 Fax: +86-755-8427 6832

Email & Skype: info@chipsmall.com Web: www.chipsmall.com

Address: A1208, Overseas Decoration Building, #122 Zhenhua RD., Futian, Shenzhen, China



Cam Positioner H8PS

CSM_H8PS_DS_E_6_2

This Compact Cam Positioner, Popular for Its Ease-of-use, Now Comes with Even Better Functions.

- Compact 8-, 16-, and 32-output Models available that are 1/4-DIN size at 96 x 96 mm.
- High-speed operation at 1,600 r/min and high-precision settings to 0.5° ensure widespread application.
- Highly visible display with backlit negative transmissive LCD.
- Advance angle compensation function to compensate for output delays.
- Bank function for multi-product production (8 banks). (H8PS-16□/-32□ models.)
- Speed display and pulse output.
- Approved standards: UL/CSA and EMC.



Refer to **Safety Precautions for All Counters and Safety Precautions** on page 18 and 19.

Features

Models with 8, 16, or 32 Outputs

The lineup includes Models with 32 outputs in a compact 1/4-DIN size. Using the optional Parallel Input Adapter (Y92C-30) enables expanding to up to 64 outputs for one encoder to support anything from a simple positioning application to a large-scale system.

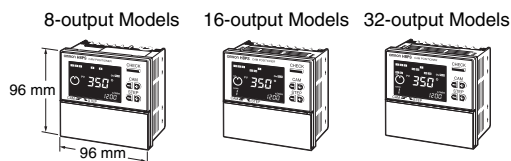

Simple Programming

The programming method is designed based on a one key-one action concept for settings that could not be simpler. Both initial settings and factory adjustments are effort-free.

Large, Backlit Negative LCDs

Large LCDs, red for the process value and green for set values, show a wealth of operation information, making operating status visible at a glance.

High Speed Up To 1,600 r/min High Precision Up To 0.5° (at 720 Resolution)

High-speed, high-precision applications can be easily handled and productivity increased.

Bank Function for Multi-product Production

Up to eight different programs can be registered in advance to enable fast and easy switching between products (16/32-output Models only).

USB Communications for Easy Setting from a Computer

Optional Support Software can be used to enable programming from a personal computer via USB communications. Programs can be easily copied, saved, printed, and much more.

Speed Display and Speed Alarm Output

Both the speed (rotations/minutes) and present angular position can be displayed at the same time. Alarm outputs can be produced for both upper and lower speed limits.

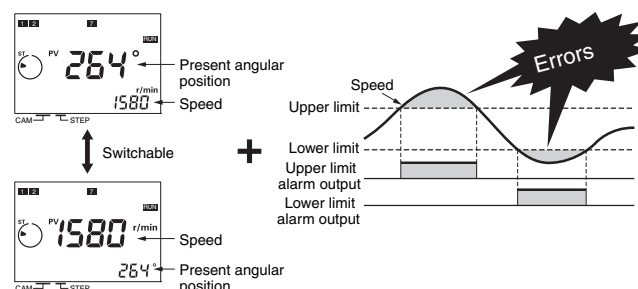

Advance Angle Compensation Function to Compensate for Output Delays

The advance angle compensation (ADV) function automatically advances the ON/OFF angle of outputs in proportion to machine (encoder) speed to compensate for the delay in timing of ON/OFF operation. ADV values can be set individually for 7 cam outputs.

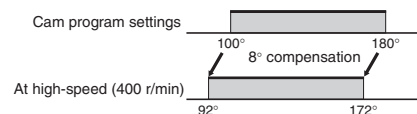

Pulse Output for Timing Control

The number of pulses per rotation and the pulse output start angle can be set to enable operations like adjusting timing with a PLC or outputting to a rotation meter.

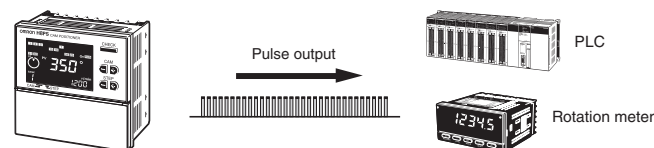

Model Number Structure

■ Model Number Legend

H8PS-□□□□
1 2 3 4

1. **Number of outputs**
8: 8 outputs
16: 16 outputs
32: 32 outputs

2. **Panel language**
B: English

3. **Mounting method**
None: Flush mounting
F: Surface mounting/
track mounting

4. **Output configuration**
None: NPN transistor output
P: PNP transistor output

Ordering Information

■ List of Models

Cam Positioner

Number of outputs	Mounting method	Output configuration	Bank function	Model
8 outputs	Flush mounting	NPN transistor output	No	H8PS-8B
		PNP transistor output		H8PS-8BP
	Surface mounting/ track mounting	NPN transistor output		H8PS-8BF
		PNP transistor output		H8PS-8BFP
16 outputs	Flush mounting	NPN transistor output	Yes	H8PS-16B
		PNP transistor output		H8PS-16BP
	Surface mounting/ track mounting	NPN transistor output		H8PS-16BF
		PNP transistor output		H8PS-16BFP
32 outputs	Flush mounting	NPN transistor output		H8PS-32B
		PNP transistor output		H8PS-32BP
	Surface mounting/ track mounting	NPN transistor output		H8PS-32BF
		PNP transistor output		H8PS-32BFP

Dedicated Absolute Encoder

Type	Resolution	Cable length	Model
Economy	256	2 m	E6CP-AG5C-C 256P/R 2M
Standard	256	1 m	E6C3-AG5C-C 256P/R 1M
		2 m	E6C3-AG5C-C 256P/R 2M
	360		
	720		E6C3-AG5C-C 720P/R 2M
Rigid	256	2 m	E6F-AG5C-C 256P/R 2M
	360		E6F-AG5C-C 360P/R 2M
	720		E6F-AG5C-C 720P/R 2M

Accessories (Order Separately)

Name	Specification	Model
Discrete Wire Output Cable	2 m	Y92S-41-200
Connector-type Output Cable	2 m	E5ZE-CBL200
Support Software	CD-ROM	H8PS-SOFT-V1
Shaft Coupling for the E6CP	Axis: 6 mm dia.	E69-C06B
Shaft Coupling for the E6C3	Axis: 8 mm dia.	E69-C08B
Shaft Coupling for the E6F	Axis: 10 mm dia.	E69-C10B
Extension Cable (See note.)	5 m (same for E6CP, E6C3, and E6F)	E69-DF5
Parallel Input Adapter	Two Units can operate in parallel.	Y92C-30
Protective Cover	---	Y92A-96B
Watertight Cover	---	Y92A-96N
Track Mounting Base	---	Y92F-91
Mounting Track	50 cm × 7.3 mm (ℓ × t)	PFP-50N
	1 m × 7.3 mm (ℓ × t)	PFP-100N
	1 m × 16 mm (ℓ × t)	PFP-100N2
End Plate	---	PFP-M
Spacer	---	PFP-S

Note: Ask your OMRON representative about the availability of non-standard lengths.

Recommended USB Cables

Name	Recommended manufacturer	Specification	Model
USB Cable	ELECOM CO.Ltd.	A-miniB, 2m	U2C-MF20BK

Note: If you can't purchase recommended replacement, please purchase commercially available USB cable that attached ferrite core.

Specifications

■ Ratings

Item		H8PS-□B	H8PS-□BF	H8PS-□BP	H8PS-□BFP
Rated supply voltage		24 VDC			
Operating voltage range		85% to 110% of rated supply voltage			
Mounting method		Flush mounting	Surface mounting, track mounting	Flush mounting	Surface mounting, track mounting
Power consumption		Approx. 4.5 W at 26.4 VDC for 8-output models Approx. 6.0 W at 26.4 VDC for 16-/32-output models			
Inputs	Encoder input		Connections to a dedicated absolute encoder		
	External inputs	Input signals	8-output Models: None 16-/32-output Models: Bank inputs 1/2/4, origin input, start input		
		Input type	No voltage inputs: ON impedance: 1 kΩ max. (Leakage current: approx. 2 mA at 0 Ω) ON residual voltage: 2 V max., OFF impedance: 100 kΩ min., Applied voltage: 30 VDC max. Minimum input signal width: 20 ms		
Outputs	Cam outputs RUN output		NPN open-collector transistor outputs 30 VDC max., 100 mA max. (Do not exceed 1.6 A total for all cam outputs and the RUN output.), residual voltage: 2 VDC max.	PNP open-collector transistor outputs 30 VDC max. (26.4 VDC for 16-/32-output Models), 100 mA max. (Do not exceed 1.6 A total for all cam outputs and the RUN output.), residual voltage: 2 VDC max.	
	Pulse output		NPN open-collector transistor output 30 VDC max., 30 mA max., residual voltage: 0.5 VDC max.	PNP open-collector transistor output 30 VDC max. (26.4 VDC for 16-/32-output Models) 30 mA max., residual voltage: 2 VDC max.	
	Number of outputs		8-output Models: 8 cam outputs, 1 RUN output, 1 pulse output 16-output Models: 16 cam outputs, 1 RUN output, 1 pulse output 32-output Models: 32 cam outputs, 1 RUN output, 1 pulse output		
Number of banks		8 banks (for 16-/32-output Models only)			
Display method		7-segment, negative transmissive LCD (Main Display: 11 mm (red), Sub-display: 5.5 mm (green))			
Memory backup method		EEPROM (overwrites: 100000 times min.) that can store data for 10 years min.			
Ambient operating temperature		-10 to 55°C (with no icing or condensation)			
Storage temperature		-25 to 65°C (with no icing or condensation)			
Ambient humidity		25% to 85%			
Degree of protection		Panel surface: IP40, Rear case: IP20			
Case color		Light gray (Munsell 5Y7/1)			

■ Characteristics

Setting unit		0.5° increments at a resolution of 720, 1° increments at a resolution of 256 or 360 (See note 1.)
Number of steps		Up to 10 steps can be set for each cam to turn the output ON/OFF 10 times. (See note 2.)
Inputs	Encoder input	Connections to a dedicated absolute encoder <ul style="list-style-type: none"> • Response rotation speed (in Run/Test Mode) 1600 r/min max. at a resolution of 256 or 360 (1200 r/min max. if ADV function is set for 4 or more cams) (See notes 3 and 4.) 800 r/min max. at a resolution of 720 (600 r/min max. if ADV function is set for 4 or more cams) • Includes error data detection
Encoder cable extension distance		256/360 resolution 100 m max. at 330 r/min or less 52 m max. at 331 to 1200 r/min (331 to 900 r/min if ADV function is set for 4 or more cams) 12 m max. at 1201 to 1600 r/min (901 to 1200 r/min if ADV function is set for 4 or more cams) 720 resolution 100 m max. at 330 r/min or less 52 m max. at 331 to 600 r/min (331 to 450 r/min if ADV function is set for 4 or more cams) 12 m max. at 601 to 800 r/min (451 to 600 r/min if ADV function is set for 4 or more cams)
Output response time		0.3 ms max.
Insulation resistance		100 MΩ min. (at 500 VDC) between current-carrying terminals and exposed non-current-carrying metal parts, between all current-carrying parts and the USB connector
Dielectric strength		1000 VAC, 50/60 Hz for 1 min between current-carrying terminals and exposed non-current-carrying metal parts 500 VAC, 50/60 Hz for 1 min between current-carrying section and USB connector, and between current-carrying terminals and non-current-carrying metal part of output connector
Impulse withstand voltage		1 kV between power terminals 1.5 kV between current-carrying terminals and exposed non-current-carrying metal parts
Noise immunity		±480 V between power terminals, ±600 V between input terminals Square-wave noise by noise simulator (pulse width: 100 ns/1 μs, 1-ns rise)
Static immunity		8 kV (malfunction), 15 kV (destruction)
Vibration resistance	Destruction	10 to 55 Hz with 0.75-mm single amplitude each in 3 directions for 2 hours each
	Malfunction	10 to 55 Hz with 0.5-mm single amplitude each in 3 directions for 10 minutes each
Shock resistance	Destruction	300 m/s ² 3 times each in 6 directions
	Malfunction	200 m/s ² 3 times each in 6 directions
Approved safety standards		cULus (Listing): UL508/CSA C22.2 No. 14
EMC		(EMI) EN61326 Emission Enclosure: EN55011 Group1 Class A (EMS) EN61326 Immunity ESD: EN61000-4-2: 4 kV contact discharge 8 kV air discharge Immunity RF-interference: EN61000-4-3: 10 V/m (Amplitude-modulated, 80 MHz to 1 GHz) 10 V/m (Pulse-modulated, 900 MHz ±5 MHz) Immunity Conducted Disturbance EN61000-4-6: 10 V (0.15 to 80 MHz) Immunity Burst: EN61000-4-4: 2 kV for power-line 1 kV for I/O signal-line Immunity Surge: EN61000-4-5: 1 kV line to line (power line) 2 kV line to ground (power line)
Weight		Approx. 300 g (Cam Positioner main unit only)

- Note:**
1. Cam output precision, however, is 2° max. for Encoder with 256 resolution (P/R).
 2. Although 32-output Models can have 10 steps set for any one output, there must be no more than 160 steps total set for all cam outputs.
 3. The maximum is 1000 r/min when an E6CP-AG5C-C Encoder is connected.
 4. ADV stands for Advance Angle Compensation.

■ Functions

Item	H8PS-8□	H8PS-16□	H8PS-32□
Encoder rotation direction switching	Encoder data can be set with a DIP switch to forward (CW) or reverse (CCW) direction.		
Encoder origin designation	The present display angular position can be set to 0° (origin) by pressing the ORIGIN Key on the front panel.	The present display angular position can be set to 0° (origin) by using the origin input terminal or the ORIGIN Key on the front panel. Note: All banks use the same origin.	
Angle display switch	Converts the Absolute Encoder value display from 256 divisions/revolution to 360°/revolution.		
Rotation display monitor	Graphically displays the Encoder rotational angular position.		
Teaching function	Sets the cam output ON/OFF angle based on actual machine (Encoder) operation.		
Pulse output	Outputs a preset number of pulses per Encoder rotation. It also sets the pulse output start angle.		
Switching the angle and speed displays	Displays both the present angular position and the number of Encoder revolutions (speed) in Run Mode. Switches back and forth between the main display showing the present angular position with the sub-display showing the speed and the main display showing the speed with the sub-display showing the present angular position.		
Bank function	---	Enables the entire cam program to be changed at one time by switching banks (0 to 7). The bank that is running can be switched using the bank input terminal or the BANK Key on the front panel. Also enables programs to be copied between banks.	
Advance angle compensation (ADV) function	Automatically advances the ON/OFF angle of cam outputs in proportion to machine (encoder) speed to compensate for the delay in timing of ON/OFF operation. ADV values can be set individually for 7 cam outputs.		
Speed alarm output	A specified cam output can be used as an Encoder speed alarm output. The function can output upper and lower limit speed alarms.		
All protection function	Disables all key and switch operations in Run Mode to prevent incorrect or unauthorized operation.		
Cam protection function	Prohibits program changes at the cam output level. Any cam numbers can be protected.		
Step number limit	Limits the number of steps that can be set per cam output. Prohibits incorrect operations by adding to the program.		
Output prohibit	---	The start input can be turned OFF in Run or Test Mode to prohibit cam output. Note: Use this function carefully for the application because no cam outputs are provided when the start input is turned OFF.	
Support Software settings	---	Programs can be uploaded or downloaded easily by connecting a personal computer to the Cam Positioner using a USB Cable (Recommended USB Cables: ELECOM CO.Ltd. U2C-MF20BK) and the Support Software (H8PS-SOFT-V1, sold separately).	

Connections

Terminal Arrangement

H8PS-8□ (8-output Models)	H8PS-16□/-32□ (16-/32-output Models)
<p>NPN Output, Flush Mounting H8PS-8□</p> <p>(Rear view)</p>	<p>NPN Output, Flush Mounting H8PS-16□/-32□</p> <p>(Rear view)</p>
<p>NPN Output, Surface Mounting H8PS-8□F</p> <p>(Front view)</p>	<p>NPN Output, Surface Mounting H8PS-16□F/-32□F</p> <p>(Front view)</p>
<p>PNP Output, Flush Mounting H8PS-8□P</p> <p>(Rear view)</p> <p>Note: The VS terminal is not internally connected to the positive (+) power supply terminal.</p>	<p>PNP Output, Flush Mounting H8PS-16□P/-32□P</p> <p>(Rear view)</p> <p>Note: The VS terminal is not internally connected to the positive (+) power supply terminal.</p>
<p>PNP Output, Surface Mounting H8PS-8□FP</p> <p>(Front view)</p> <p>Note: The VS terminal is not internally connected to the positive (+) power supply terminal.</p>	<p>PNP Output, Surface Mounting H8PS-16□FP/-32□FP</p> <p>(Front view)</p> <p>Note: The VS terminal is not internally connected to the positive (+) power supply terminal.</p>

Note: For PNP output models, the VS terminal and power supply terminals are not connected internally.

Output Cable Connections (16-/32-output Models Only)

Flush Mounting Models

Output Connector 1 (CN1) Output Connector 2 (CN2) (See note.)

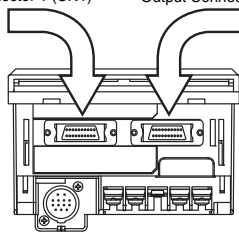

(Bottom view)

Surface Mounting Models

Output Connector 1 (CN1) Output Connector 2 (CN2) (See note.)

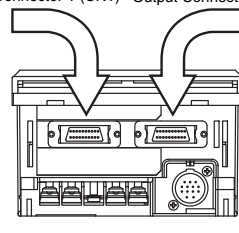

(Bottom view)

Output Connector	Output signals
Output Connector 1 (CN1)	Cam 1 to Cam 16, COM, Vs
Output Connector 2 (CN2) (See note.)	Cam 17 to Cam 32, COM, Vs

Note: The 16-output Models do not have CN2 Connectors.

1. E5ZE-CBL200 Connector-type Output Cable (Order Separately) Connections

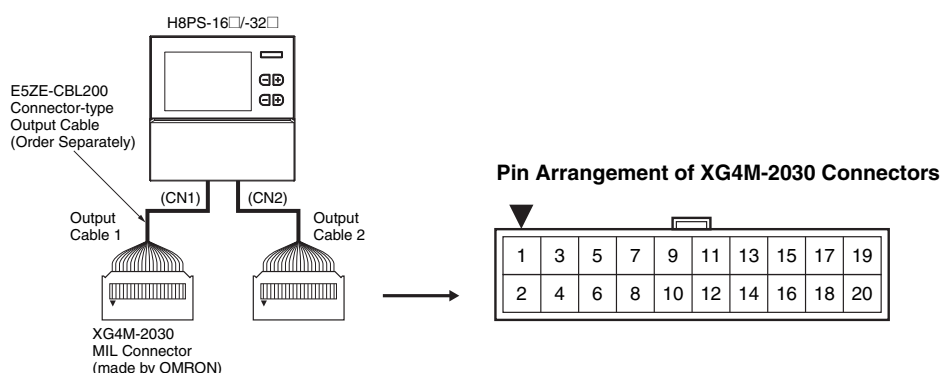

Output Cable 1 Wiring Table

Outputs	Connector pin No.	Outputs	Connector pin No.
Cam 1	20	Cam 9	19
Cam 2	18	Cam 10	17
Cam 3	16	Cam 11	15
Cam 4	14	Cam 12	13
Cam 5	12	Cam 13	11
Cam 6	10	Cam 14	9
Cam 7	8	Cam 15	7
Cam 8	6	Cam 16	5
COM	4	COM	3
Vs	2	Vs	1

Output Cable 2 Wiring Table

Outputs	Connector pin No.	Outputs	Connector pin No.
Cam 17	20	Cam 25	19
Cam 18	18	Cam 26	17
Cam 19	16	Cam 27	15
Cam 20	14	Cam 28	13
Cam 21	12	Cam 29	11
Cam 22	10	Cam 30	9
Cam 23	8	Cam 31	7
Cam 24	6	Cam 32	5
COM	4	COM	3
Vs	2	Vs	1

- Note:**
- The COM pins in the output connectors are connected inside the Cam Positioner to the negative terminal of the 24-VDC power supply input.
 - The Vs pins in the output connectors are connected inside the Cam Positioner to the Vs terminal.
 - The Vs pins in the output connectors are not used on models with NPN outputs.
 - The COM pins in output connector 1 and output connector 2 are connected to each other inside the Cam Positioner. The Vs pins in output connector 1 and output connector 2 are also connected to each other inside the Cam Positioner.

Using Connector-Terminal Block Conversion Units

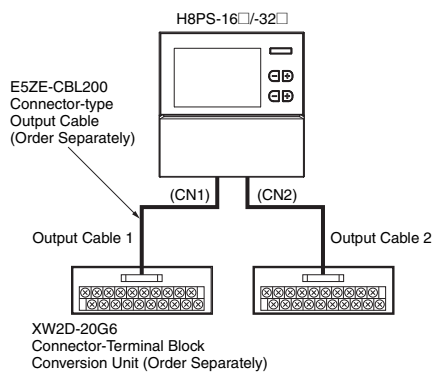

Terminal Arrangement of the XW2D-20G6 Connector-Terminal Block Conversion Unit

Output Cable 1

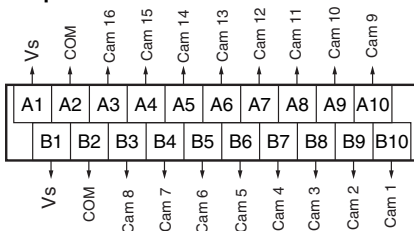

Output Cable 2

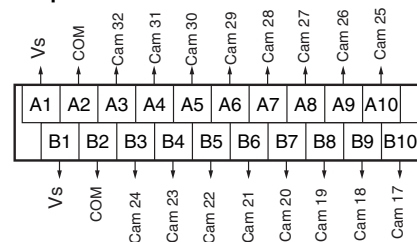

2. Y92S-41-200 Discrete Wire Output Cable (Order Separately) Connections

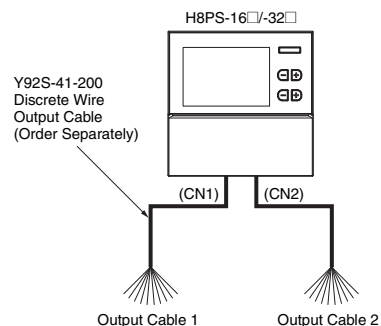

Output Cable 1 Wiring Table

Outputs	Cable color	Marks	Marking color	Outputs	Cable color	Marks	Marking color
Cam 1	Orange	■	Black	Cam 9	Orange	■	Red
Cam 2	Gray	■	Black	Cam 10	Gray	■	Red
Cam 3	White	■	Black	Cam 11	White	■	Red
Cam 4	Yellow	■	Black	Cam 12	Yellow	■	Red
Cam 5	Pink	■	Black	Cam 13	Pink	■	Red
Cam 6	Orange	■ ■	Black	Cam 14	Orange	■ ■	Red
Cam 7	Gray	■ ■	Black	Cam 15	Gray	■ ■	Red
Cam 8	White	■ ■	Black	Cam 16	White	■ ■	Red
COM	Yellow	■ ■	Black	COM	Yellow	■ ■	Red
Vs	Pink	■ ■	Black	Vs	Pink	■ ■	Red

Output Cable 2 Wiring Table

Outputs	Cable color	Marks	Marking color	Outputs	Cable color	Marks	Marking color
Cam 17	Orange	■	Black	Cam 25	Orange	■	Red
Cam 18	Gray	■	Black	Cam 26	Gray	■	Red
Cam 19	White	■	Black	Cam 27	White	■	Red
Cam 20	Yellow	■	Black	Cam 28	Yellow	■	Red
Cam 21	Pink	■	Black	Cam 29	Pink	■	Red
Cam 22	Orange	■ ■	Black	Cam 30	Orange	■ ■	Red
Cam 23	Gray	■ ■	Black	Cam 31	Gray	■ ■	Red
Cam 24	White	■ ■	Black	Cam 32	White	■ ■	Red
COM	Yellow	■ ■	Black	COM	Yellow	■ ■	Red
Vs	Pink	■ ■	Black	Vs	Pink	■ ■	Red

Input Connections

Only the Encoder inputs are connected with 8-output Models. The inputs are no-voltage (short-circuit or open) inputs.

No-voltage Inputs

Open Collector

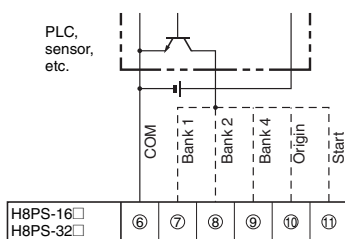

Note: Operates when the transistor turns ON.

Contact Input

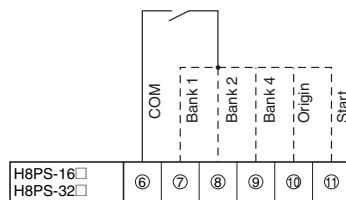

Note: Operates when the contact turns ON.

Voltage-output sensors can also be connected.

Connection Examples

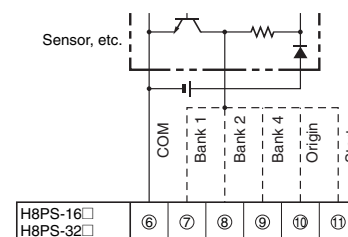

Note: Operates when the transistor turns ON.

No-voltage Input Signal Levels

No-contact inputs	Short-circuit level for transistor ON
	<ul style="list-style-type: none"> Residual voltage: 2 V max. Impedance when ON: 1 kΩ max. (The leakage current is approx. 2 mA when the impedance is 0 Ω.)
Contact inputs	Open level for transistor OFF
	<ul style="list-style-type: none"> Impedance when OFF: 100 kΩ min.
Use a contact that can adequately switch 2 mA at 5 V.	

Note: Use a maximum DC power supply of 30 V.

Output Connections

Note: Internal circuit damage may result from a short circuit in the load.

NPN Output Models

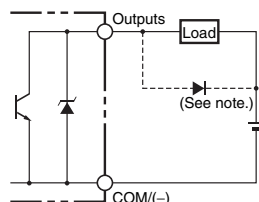

Note: Always connect a diode to absorb counter-electromotive force when connecting an inductive load.

Item	Cam outputs, RUN output	Pulse output
Output method	NPN open collector	
Dielectric strength	30 VDC	
Rated current	100 mA (See note.)	30 mA
Residual voltage	2 VDC max.	0.5 VDC max.
Leakage current	100 μ A max.	5 μ A max.

Note: Do not exceed 1.6 A total for all cam outputs and the RUN output.

PNP Output Models

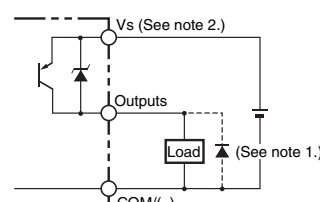

Note: 1. Always connect a diode to absorb counter-electromotive force when connecting an inductive load.
2. The VS terminal and power supply terminals are not connected internally.

Item	Cam outputs, RUN output	Pulse output
Output method	PNP open collector	
Dielectric strength	8-output Models: 30 VDC 16-/32-output Models: 26.4 VDC	
Rated current	100 mA (See note.)	30 mA
Residual voltage	2 VDC max.	
Leakage current	100 μ A max.	

Note: Do not exceed 1.6 A total for all cam outputs and the RUN output.

Operating Mode

■ Functions

The H8PS Cam Positioner receives angle signal inputs from the Dedicated Absolute Encoder and outputs the preset ON/OFF angles as cam outputs.

Program Examples

1. H8PS-8□ (8-output Models)

Cam output (cam number)	Step 0		Step 1		...	Step 9	
	ON angle	OFF angle	ON angle	OFF angle		ON angle	OFF angle
1	45°	90°	135°	225°		270°	315°
2	0°	90°	135°	180°		---	---
⋮							
8	90°	225°	270°	285°		315°	345°

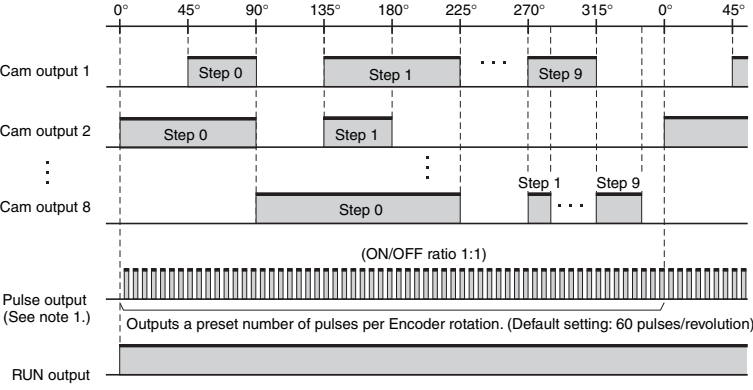

- Note 1:** The number of pulses per Encoder rotation and the pulse output start angle can be set.
- Note 2:** With counterclockwise rotation (359°, 358° ...1°, 0°), step 0 for cam output 1 turns ON at 89° and OFF at 44° at in the diagram.

RUN output: ON during Run or Test Mode. OFF when an error occurs.

2. H8PS-16□ /-32□ (16-/32-output Models)

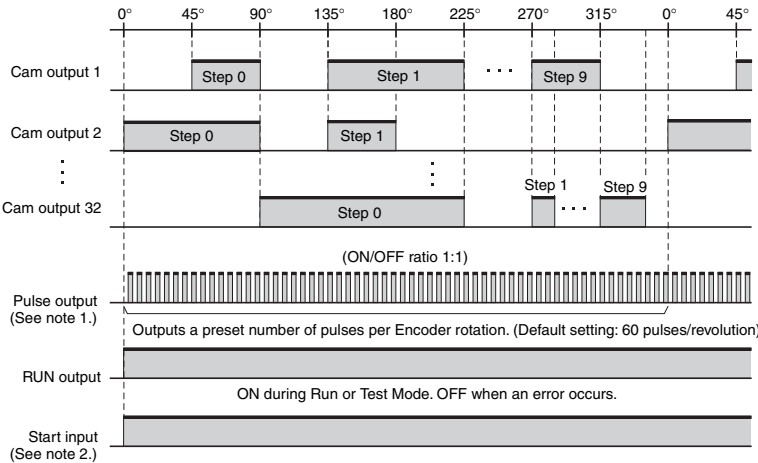
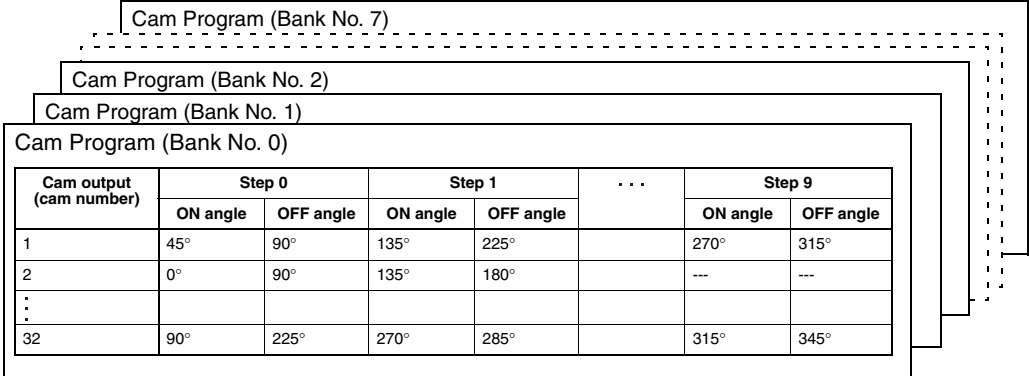

- Note 1:** The number of pulses per Encoder rotation and the pulse output start angle can be set.
- Note 2:** Be sure to turn ON the start input in Run and Test modes. Otherwise, there will be no outputs (output prohibited), including the cam outputs, pulse output, and RUN output.
- Note 3:** With counterclockwise rotation (359°, 358° ...1°, 0°), step 0 for cam output 1 turns ON at 89° and OFF at 44° in the diagram.

Note: The entire cam program can be changed at one time with 16- and 32-output Models with the bank function (banks 0 to 7). For details on the procedure for switching banks, refer to page 29.

Nomenclature

Displays

8-output Models

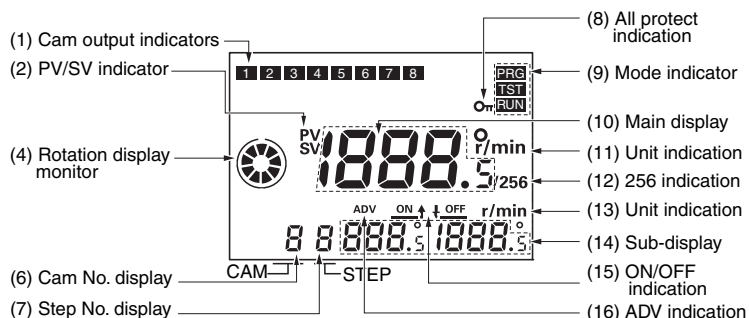

16-/32-output Models

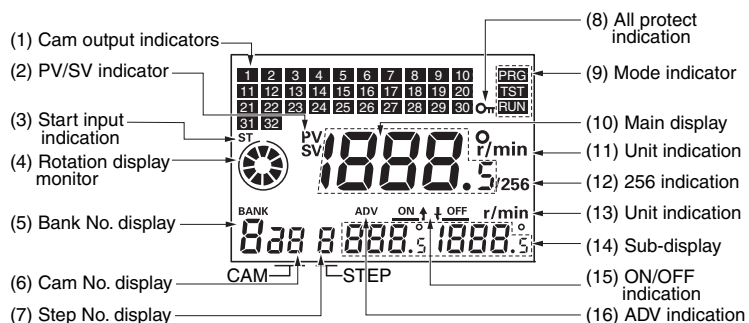

Display Details

No.	Display color	Description
(1)	Orange	Lit while cam outputs are ON.
(2)	Red	PV: Lit while the present angular position or speed is displayed in main display. SV: Lit while the setting value is displayed in main display.
(3)	Orange	Lit while the start input is ON in Run or Test Mode. Not lit when an error occurs.
(4)	Orange	Displays Encoder present angular position, direction, and speed guidelines.
(5)	Green	Displays the bank number that is running in Run or Test Mode and the bank number selected in Programming Mode.
(6)	Green	Displays the cam number for the angle setting displayed on sub-display.
(7)	Green	Displays the step number for the angle setting displayed on sub-display.
(8)	Orange	Lit while the All Protection function is enabled.
(9)	Orange	The indicator for the selected mode is lit. PRG: Programming Mode TST: Test Mode RUN: Run Mode
(10)	Red	Displays the present angular position or the speed and settings being made.
(11)	Red	Displays units for the angle or the speed displayed on main display.
(12)	Red	Lit while using an Encoder with a resolution of 256 if 256° display is selected.
(13)	Green	Displays units for the angle or the speed displayed on sub-display.
(14)	Green	Displays the speed or the ON/OFF angle settings.
(15)	Green	Indicates whether main display displays the ON or OFF angle setting.
(16)	Green	Lit while setting the Advance Angle Compensation (ADV) Function.

Operation Keys

8-output Models

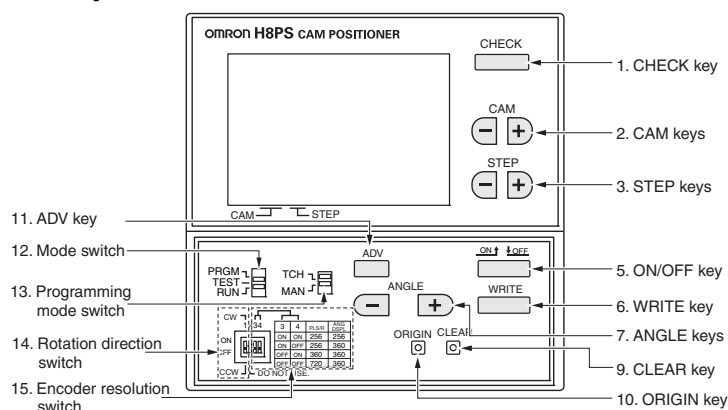

16-/32-output Models

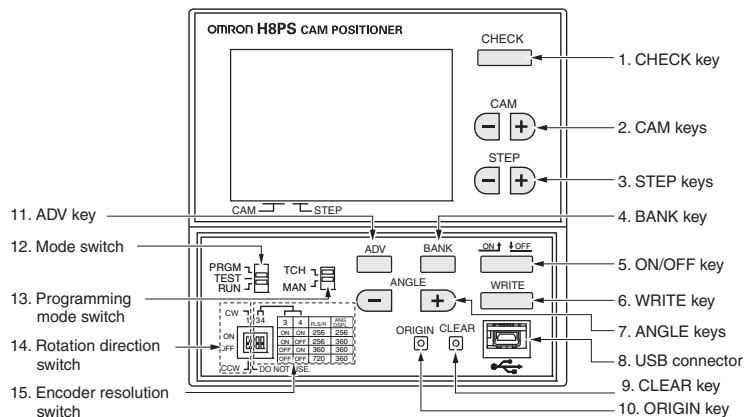

Operation Key Details

No.	Description
1	Displays program details in Run Mode.
2	Selects the cam number with [+/-] Keys.
3	Selects the step number with [+/-] Keys.
4	Selects the bank number.
5	Selects the ON angle, or OFF angle
6	Writes the set data to memory.
7	Changes the angle or other setting value with [+/-] Keys.
8	Connects the Cam Positioner to a personal computer via USB cable (order separately) for programming with the Support Software (order separately).
9	Moves to the screen for clearing settings
10	Designates the current angle of the machine (Encoder) as the origin (0°).
11	Programming or Test Mode: Press to shift to the ADV function setting screen. Programming Mode: Press and hold at least 3 s to shift to the Function Setting Mode. Run Mode: Press and hold at least 5 s to enable/disable the All Protection function.
12	Switches modes. Programming Mode (PRGM): Used to write cam programs, set the ADV function, etc. Test Mode (TEST): Used to modify settings while the Encoder is running. Run Mode (RUN): Used for normal operation and to check the cam program.
13	Select the method used for programming cams. Teaching: ON/OFF Angles can be set based on actual machine (Encoder) operation. Manual: ANGLE Keys can be used to set ON/OFF angles.
14	Sets the H8PS rotation direction (rotation display monitor, etc.) to the machine (Encoder) rotation direction.
15	Sets the resolution of the connected Encoder. Also sets the unit for angle display when using an Encoder with a resolution of 256.

Dimensions

Note: All units are in millimeters unless otherwise indicated.

■ Main Unit

Cam Positioners

Flush Mounting Models H8PS-8B□ (8-output Models)

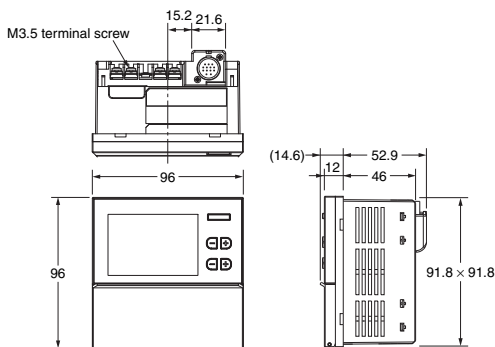
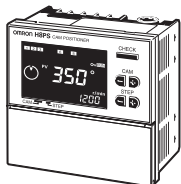

Panel Cutout (according to DIN 43700)

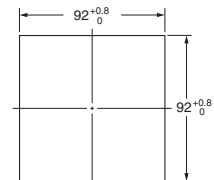

Note: Mounting panel thickness must be 1 to 5 mm.

Flush mounting

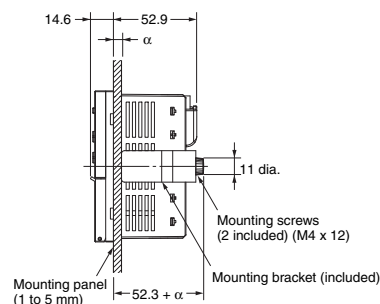

Note: An 8-output Model is shown in the above diagrams. The Encoder is connected from the bottom with 16-/32-output Models.

H8PS-16B□ (16-output Models) H8PS-32B□ (32-output Models)

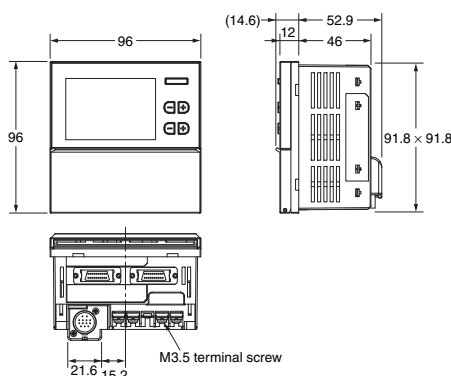

Surface Mounting Models H8PS-8BF□ (8-output Models)

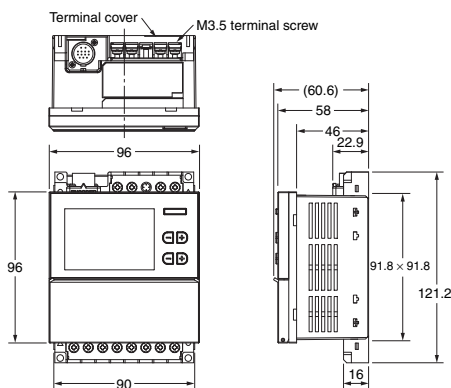
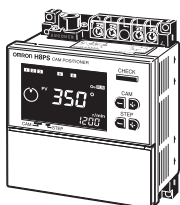

Mounting holes

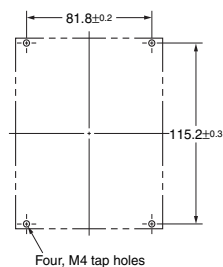

H8PS-16BF□ (16-output Models) H8PS-32BF□ (32-output Models)

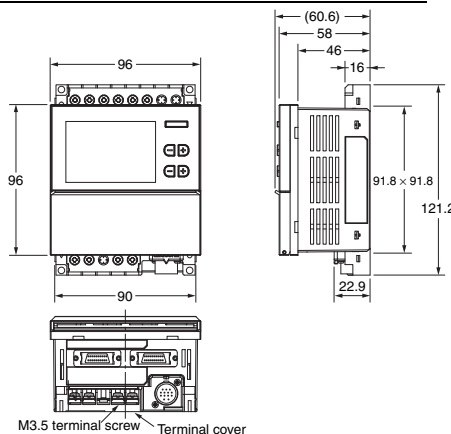
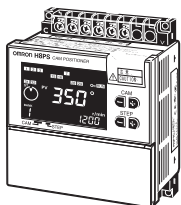

Surface Mounting

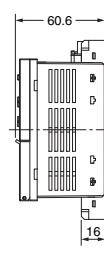

Track Mounting

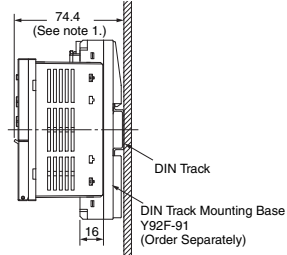

Note: 1. These dimensions vary with the kind of DIN track (reference value).

2. An 8-output Model is shown in the above diagrams. The Encoder is connected from the bottom with 16-/32-output Models.

Encoder Connecting Direction

H8PS-8B□

H8PS-8BF□

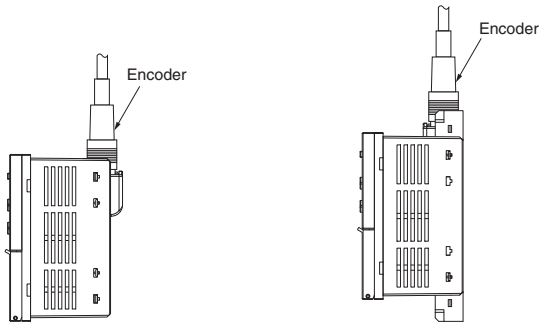

H8PS-16B□
H8PS-32B□

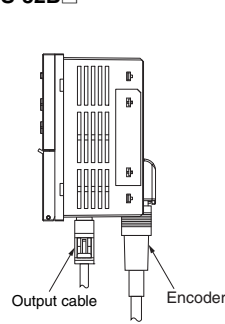

H8PS-16BF□
H8PS-32BF□

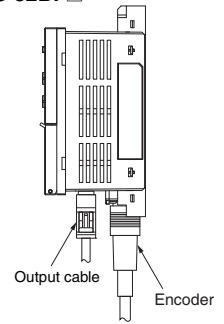

■ Accessories (Order Separately)

Parallel Input Adapters

Y92C-30

This Adapter enables two H8PS Cam Positioners to share signals from an Encoder.

Note: H8PS has been improved in 2004 April.
Do not mix old and new model with Y92C-30.
When you use 2 x H8PS, please use by "Old & Old" or "New & New" models.

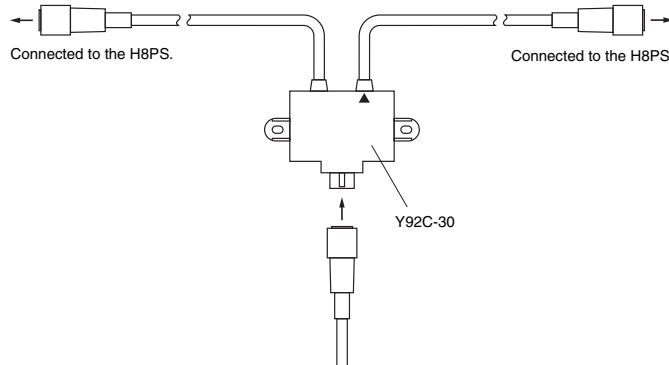
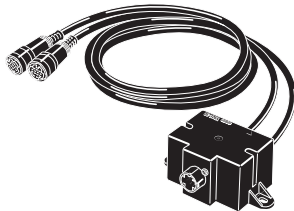

Use the cable marked with a triangle when connecting only one H8PS Cam Positioner to the Parallel Input Adapter.

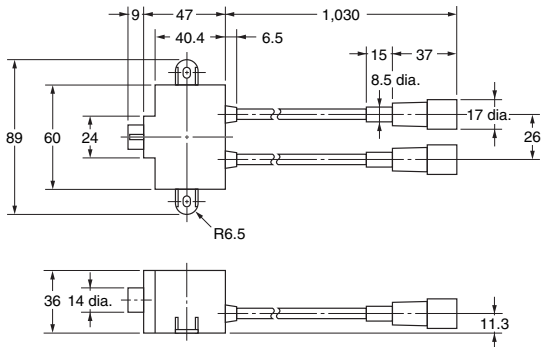

• Panel Surface Mounting

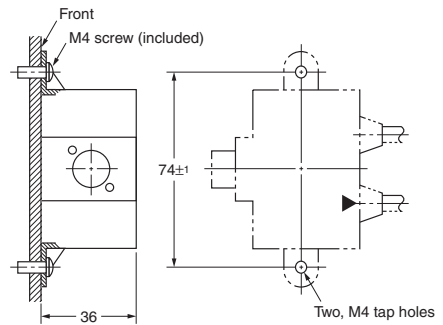

• Panel Back Mounting

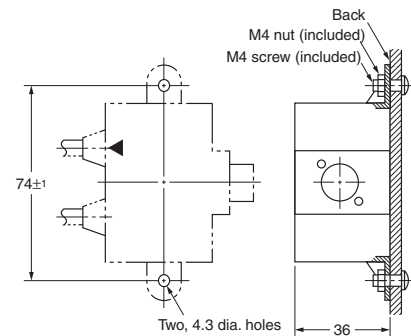

■ Accessories (Order Separately)

Watertight Cover

Y92A-96N

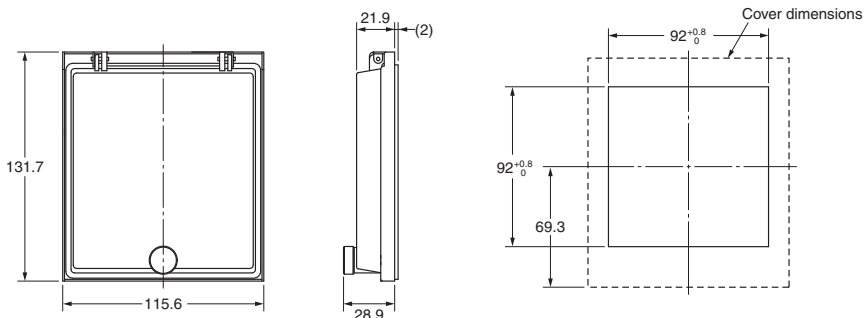
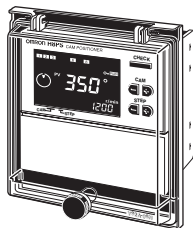

Use for flush mounting when waterproofing is required. The Y96A-96N conforms to IP66 and NEMA4 (for indoor use) standards for waterproofing. The operating environment may cause the waterproof packing to deteriorate, shrink, or harden. Therefore, it is recommended that the packing be replaced regularly.

Protective Cover

Y92A-96B

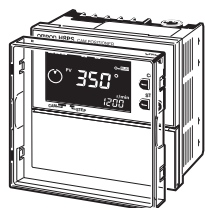

A hardened Y92A-96B Protective Cover is available. Use it for the following:

- To protect the front panel from dust and dirt.
- To prevent the set value from being altered due to accidental contact with the keys or switches.

DIN Track Mounting Base

Y92F-91

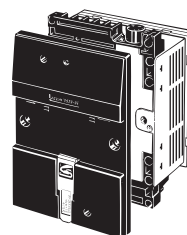

Discrete Wire Output Cable

Y92S-41-200

Cable length: 2 m

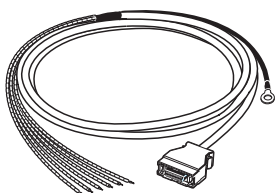

Connector-type Output Cable

E5ZE-CBL200

Cable length: 2 m

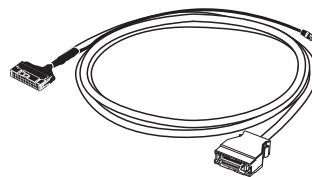

Mounting Track

PFP-100N
PFP-50N

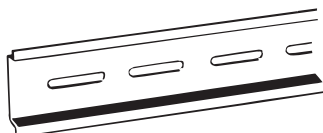

PFP-100N2

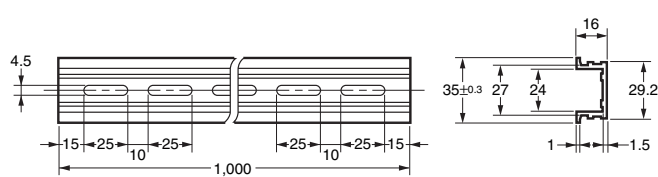
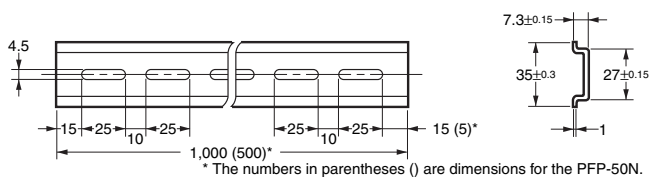
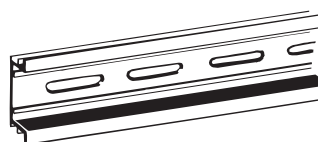

* The numbers in parentheses () are dimensions for the PFP-50N.

End Plate

PFP-M

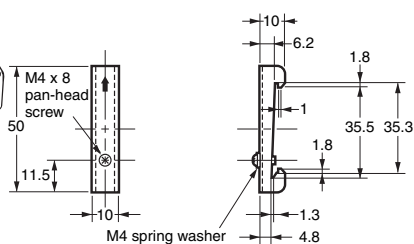
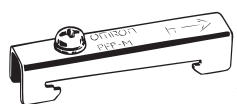

Spacer

PFP-S

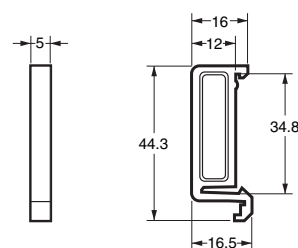
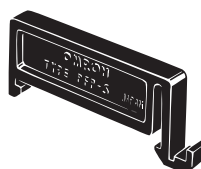

E6CP-A/E6C3-A/E6F-A Rotary Encoders (Absolute)

- Combining this Encoder with an H8PS Cam Positioner enables high-precision detection of the operation timing of various automatic machines.
- The E6CP-A is a low-cost, money-saving Encoder.
- The standard E6C3-A is well suited to environments subject to water and oil.
- The standard E6F-A is a rigid type that is compatible with high shaft-tolerance applications as well as environments subject to water and oil.

Note: Refer to the relevant datasheet for details.



Ratings and Characteristics

Item	E6CP-AG5C-C	E6C3-AG5C-C	E6F-AG5C-C
Rated supply voltage	12 VDC -10% to 24 VDC +15%, ripple (p-p) 5% max.		
Current consumption (See note 1.)	70 mA max.		60 mA max.
Resolution (pulses per rotation)	256 (8-bit)	256 (8-bit), 360 (9-bit), or 720 (10-bit)	
Output code	Gray binary		
Output configuration	NPN open-collector output		
Output capacity	Applied voltage: 28 VDC max. Sink current: 16 mA max. Residual voltage: 0.4 V max. (sink current at 16 mA)	Applied voltage: 30 VDC max. Sink current: 35 mA max. Residual voltage: 0.4 V max. (sink current at 35 mA)	
Logic	Negative logic (H = 0, L = 1)		
Accuracy	Within $\pm 1^\circ$		
Rotation direction	Clockwise (viewed from the shaft) for output code increment		
Rise and fall times of output	1.0 μ s max. (control output voltage: 16 V; load resistance: 1 k Ω ; output cord: 2 m max.)	1.0 μ s max. (control output voltage: 5 V; load resistance: 1 k Ω ; output cord: 2 m max.)	
Starting torque	0.98 m N·m max.	10 m N·m max. (at room temperature), 30 m N·m max. (at low temperature)	9.8 m N·m max. (at room temperature), 14.7 m N·m max. (at low temperature)
Moment of inertia	1 $\times 10^{-6}$ kg·m ² max.	2.3 $\times 10^{-6}$ kg·m ² max.	1.5 $\times 10^{-6}$ kg·m ² max.
Shaft-load tolerance	Radial	29.4 N	80 N
	Thrust	19.6 N	50 N
Max. permissible rotation	1000 r/min	5000 r/min	
Ambient temperature	-10 to 55°C (with no icing)		-10 to 70°C (with no icing)
Storage temperature	-25 to 85°C (with no icing)		-25 to 80°C (with no icing)
Ambient humidity	35% to 85% (with no condensation)		
Degree of protection	IEC standard IP50	IEC standard IP65 (JEM standard IP65f) (See note 2.)	IEC standard IP65 (JEM standard IP65f)
Insulation resistance	200 M Ω min. (at 500 VDC) between charged parts and the case		
Dielectric strength	500 VAC, 50/60 Hz for 1 min between charged parts and the case		
Vibration resistance	Destruction: 10 to 55 Hz, 1.5-mm double amplitude for 2 hr each in X, Y, and Z directions	Destruction: 10 to 500 Hz, 2-mm double amplitude, 150 m/s ² 3 times each in X, Y, and Z directions, 11-min sweep time	Destruction: 10 to 500 Hz, 1.5-mm double amplitude 3 times each in X, Y, and Z directions, 11-min sweep time
Shock resistance	Destruction: 1000 m/s ² 3 times each in X, Y, and Z directions		
Weight	Approx. 200 g (with 2-m cord)	Approx. 300 g (with 1-m cord)	Approx. 500 g (with 2-m cord)
Datasheet Cat. No.	---	F058	E283

Note: 1. The following inrush currents flow when the power is turned ON.

- E6CP-AG5C-C: Approx. 8 A (time: approx. 0.3 ms),
- E6C3-AG5C-C: Approx. 6 A (time: approx. 0.8 ms),
- E6F-AG5C-C: Approx. 9 A (time: approx. 5 μ s)

2. JEM1030: Applicable as of 1991

Dimensions

Note: All units are in millimeters unless otherwise indicated.

E6CP-AG5C-C



Note: Order the E69-C06B Coupling separately.

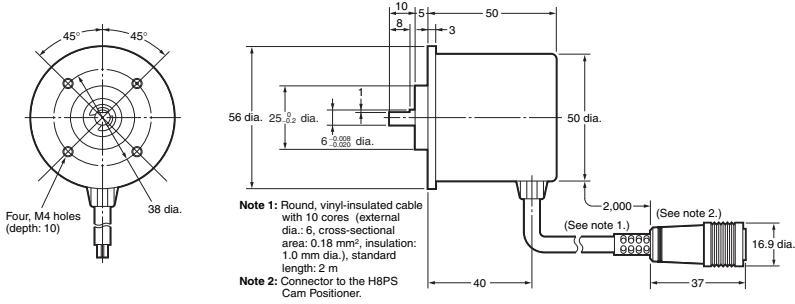

Accessory Mounting Bracket (Included)

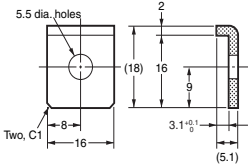

Bracket Mounting Diagram

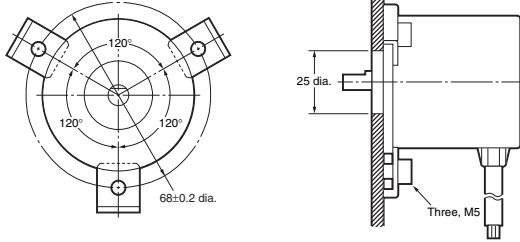

E6C3-AG5C-C



Note: Order the E69-C08B Coupling separately.

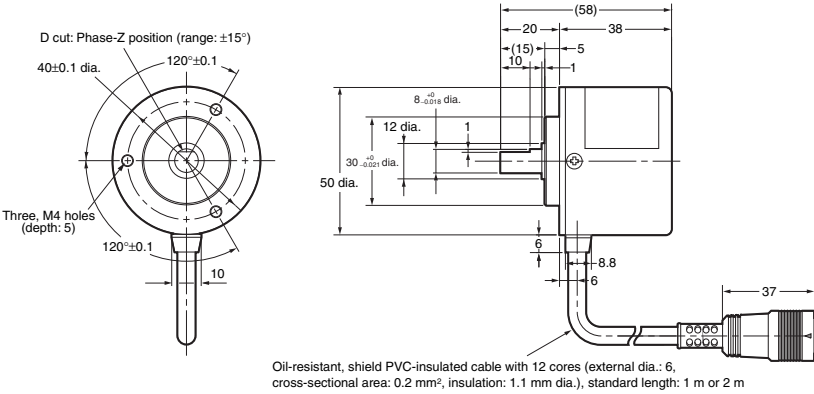

E6F-AG5C-C

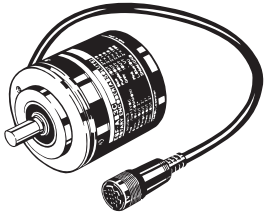

Note: Order the E69-C10B Coupling separately.

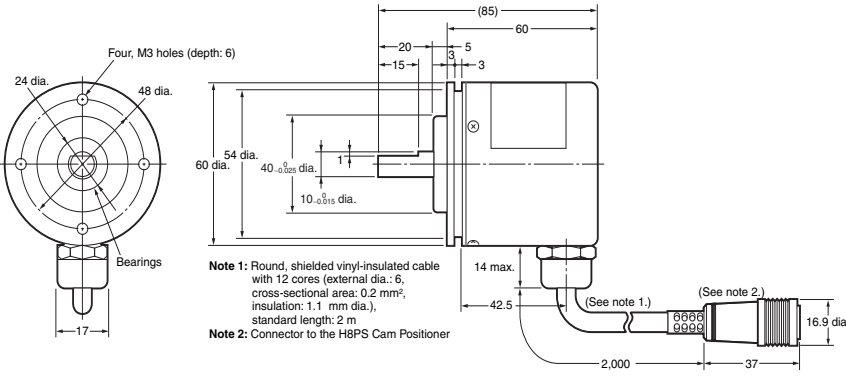

Accessory Mounting Bracket (included)

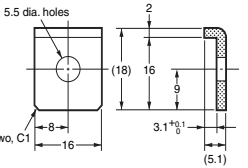

Bracket Mounting Diagram

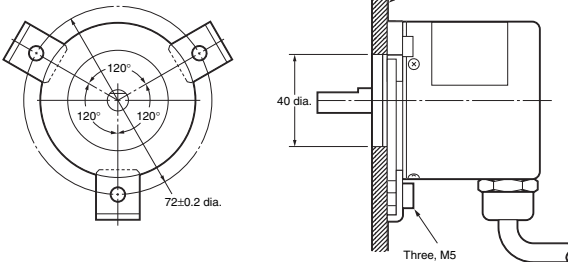

Accessories (Order Separately)

E69-C06B Shaft Coupling (for the E6CP)

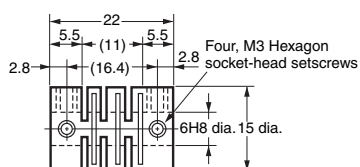

Note: The material is fiber-glass-reinforced polybutylene terephthalate resin (PBT).

E69-C08B Shaft Coupling (for the E6C3)

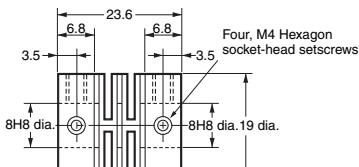

Note: The material is fiber-glass-reinforced polybutylene terephthalate resin (PBT).

E69-C10B Shaft Coupling (for the E6F)

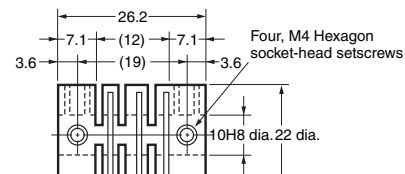

Note: The material is fiber-glass-reinforced polybutylene terephthalate resin (PBT).

E69-DF5 Extension Cable

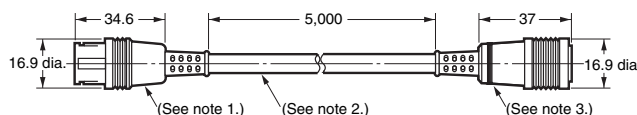
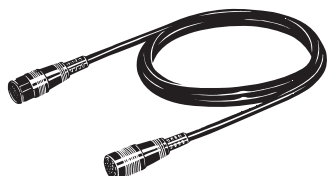

Note 1: E6F-AG5C-C, E6CP-AG5C-C, and E6C3-AG5C-C Connectors for the H8PS.

Note 2: 6-dia., 12-core shielded cable (cross-sectional area: 0.2 mm², insulation: 1.1 mm dia.), standard length: 5 m

Note 3: Connected to the H8PS Cam Positioner.

Note: Refer to *Characteristics* on page 4 for the maximum cable length.

The following models are also available: E69-DF10 (10 m), E69-DF15 (15 m), E69-DF20 (20 m), and E69-DF98 (98 m).

Safety Precautions for Encoders

Precautions for Correct Use

- Do not subject the E6CP Encoder to oil or water.
- The Encoder consists of high-precision components. Handle it with utmost care and do not drop it, otherwise malfunctioning may result.
- When connecting the shaft of the Encoder with a chain timing belt or gear, connect the chain timing belt or gear with the shaft via a bearing or coupling as shown in the following diagram.

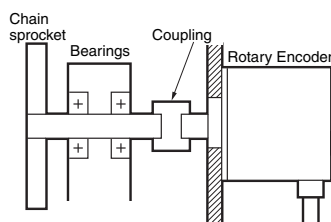

- If the decentering or declination value exceeds the tolerance, an excessive load imposed on the shaft may damage or shorten the life of the Encoder.
- Do not place excessive loads on the shaft if the shaft is connected to a gear.
- The tightening torque must not exceed the value given in the table at the right when the Rotary Encoder is mounted with screws.
- Do not pull wires with a force greater than 29.4 N while the Rotary Encoder is secured and wired.

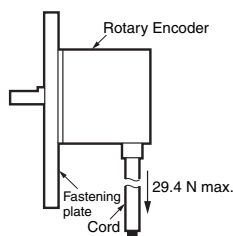

- Do not subject the shaft to shock. Therefore, do not strike the shaft or coupling with a hammer when inserting the shaft into the coupling.
- Make sure there is no foreign matter in the Connector before connecting it to the Encoder.

Mounting Procedure

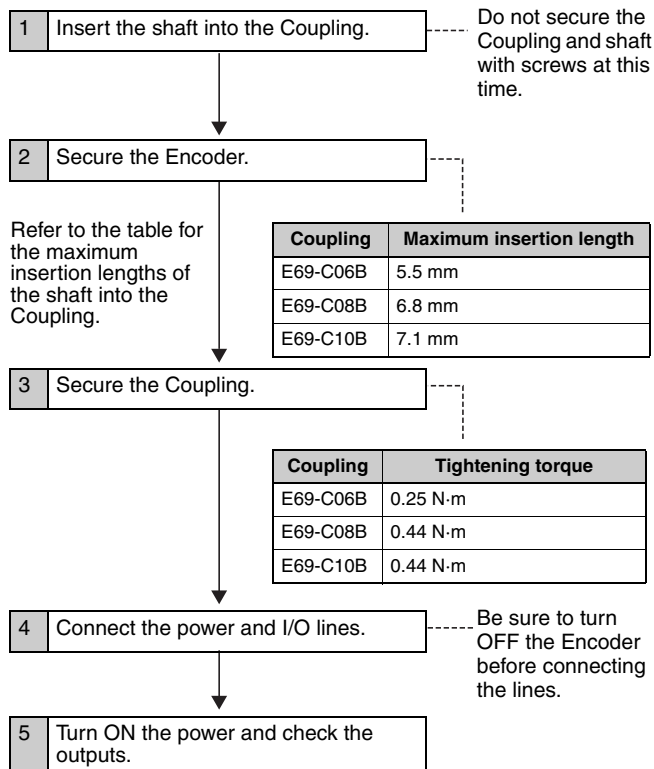

Safety Precautions for Cam Positioners

Refer to *Safety Precautions for All Counters*.

⚠ CAUTION

Tighten terminal screws to a torque of 0.80 N·m so that they do not become loose.
Minor fires or malfunction may occasionally occur.



For 16- and 32-output Models, leave the protective label attached to the H8PS when wiring. Removing the label before wiring may occasionally result in fire if foreign matter enters the Unit.

Remove the label after the completion of wiring to ensure proper heat dissipation. Leaving the label attached may occasionally result in fire.



Do not disassemble, modify, or repair the H8PS or touch any of the internal parts. Otherwise, minor electric shock, fire, or malfunction may occasionally occur.



Do not allow metal fragments, lead wire scraps, or chips from processing during installation to fall inside the H8PS. Otherwise, minor electric shock, fire, or malfunction may occasionally occur.



Do not touch the terminals when power is being supplied. For Surface-mounting H8PS, always connect the terminal cover for after completing wiring. Otherwise, minor injury due to electric shock may occasionally occur.



■ Precautions for Safe Use

Observe the following items to ensure the safe use of this product.

Environmental Precautions

- Store the H8PS within specified ratings. If the H8PS has been stored at temperatures -10°C or lower, let it stand for 3 hours or longer at room temperature before turning ON the power supply.
- Use the H8PS within the specified ratings for operating temperature and humidity.
- Do not operate the H8PS in locations subject to sudden or extreme changes in temperature, or locations where high humidity may result in condensation.
- Do not use the H8PS in locations subject to vibrations or shock. Extended use in such locations may result in damage due to stress.
- Do not use the H8PS in locations subject to excessive dust, corrosive gas, or direct sunlight.
- Install the H8PS well away from any sources of static electricity, such as pipes transporting molding materials, powders, or liquids.
- The H8PS is not waterproof or oil resistant. Do not use it in locations subject to water or oil.
- The life expectancy of internal components may be reduced if the H8PS is mounted side-by-side.
- Do not use organic solvents (such as paint thinner or benzene), strong alkaline, or strong acids because they will damage the external finish.

Usage Precautions

- Install a switch or circuit breaker that allows the operator to immediately turn OFF the power, and label it to clearly indicate its function.
- Pay careful attention to polarity to avoid wrong connections when wiring terminals.
- Do not connect more than two crimp terminals to the same terminal.
- Use the specified wires for wiring.
Applicable Wires
AWG24 to AWG18 (cross-sectional area of 0.208 to 0.832 mm²)
Solid or twisted wires of copper
- Do not connect loads that exceed the rated output current. The output elements may be destroyed, possibly resulting in short-circuit or open-circuit faults.
- Always connect a diode to protect against counterelectromotive force when using an inductive load. Counterelectromotive force may destroy output elements, possibly resulting in short-circuit or open-circuit faults.
- Use the specified cables to connect outputs.
- Do not install input lines in the same duct or conduit as power supply or other high-voltage lines. Doing so may result in malfunction due to noise. Separate the input lines from high-voltage lines.
- Internal elements may be destroyed if a voltage outside the rated voltage is applied.
- Maintain voltage fluctuations in the power supply within the specified range.
- Use a switch, relay, or other contact so that the rated power supply voltage will be reached within 0.1 s. If the power supply voltage is not reached quickly enough, the H8PS may malfunction or outputs may be unstable.
- Do not turn OFF the power supply when changing or deleting settings. The contents of the EEPROM may be corrupted.

■ Precautions for Correct Use

- A cam output will remain ON if the set angles for two steps overlap for the same cam number.

Step 1: 120° ON → 170° OFF

Step 2: 150° ON → 210° OFF

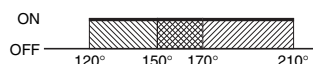

- A step will produce no output if the ON and OFF angle for the step are the same.
- The RUN output does not turn ON during programming.

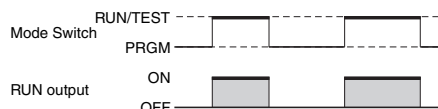

Note: The RUN output turns ON with the timing shown in the diagram, but it remains OFF when an error occurs. Thus, you can use the output as a timing signal during operation, including trial operation.

- Input signals may be accepted, not accepted, or unstable for the following times when the power supply is turned ON or OFF. Set the system to allow leeway in the timing of input signals. Approx. 1 second is required from the time the power supply is turned ON until outputs are made. Refer to the *Operation Manual* (Cat. No. Z199) for information on other timing.

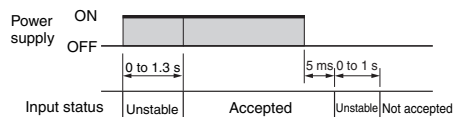

- When using 16-/32-output Modules, the operation timing of the outputs will be as shown below in relation to the ON/OFF timing of the start input. Refer to *Bank Functions (F7/F8/F9)* on page 29 when switching banks.

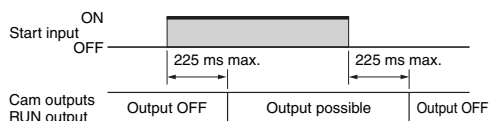

- Do not subject H8PS Connectors (outputs, Encoder) to more than 30 N of force.
- Confirm the waveform of the power supply circuit and install a surge absorber. Surge or noise applied to the power supply may destroy internal elements or cause malfunctions.
- Switch the power supply circuit with a device rated at 3.5 A or higher.
- Inrush current of approximately 3.5 A will flow for a short period of time when the power supply is turned ON. The H8PS may not start if the capacity of the power supply is not sufficient. Be sure to use a power supply with sufficient capacity.
- EEPROM is used as memory when the power is interrupted. The write life of the EEPROM is 100000 writes. The EEPROM is written when settings are changed or deleted or when the resolution is changed.
- Make sure that all settings are appropriate for the application. Unexpected operation resulting in property damage or accidents may occur if the settings are not appropriate.
- Connect all negative (-) terminals, COM terminals, and V_s terminals.
- When using the Y92C-30 Parallel Input Adapter for parallel operation, do not connect more than two H8PS Cam Positioners to the same Encoder.

Refer to the following manual for precautions in using the Cam Positioner and other information required for operation:
H8PS Cam Positioner Operation Manual (Cat. No. Z199)

Operating Procedures

■ Flow of Operation

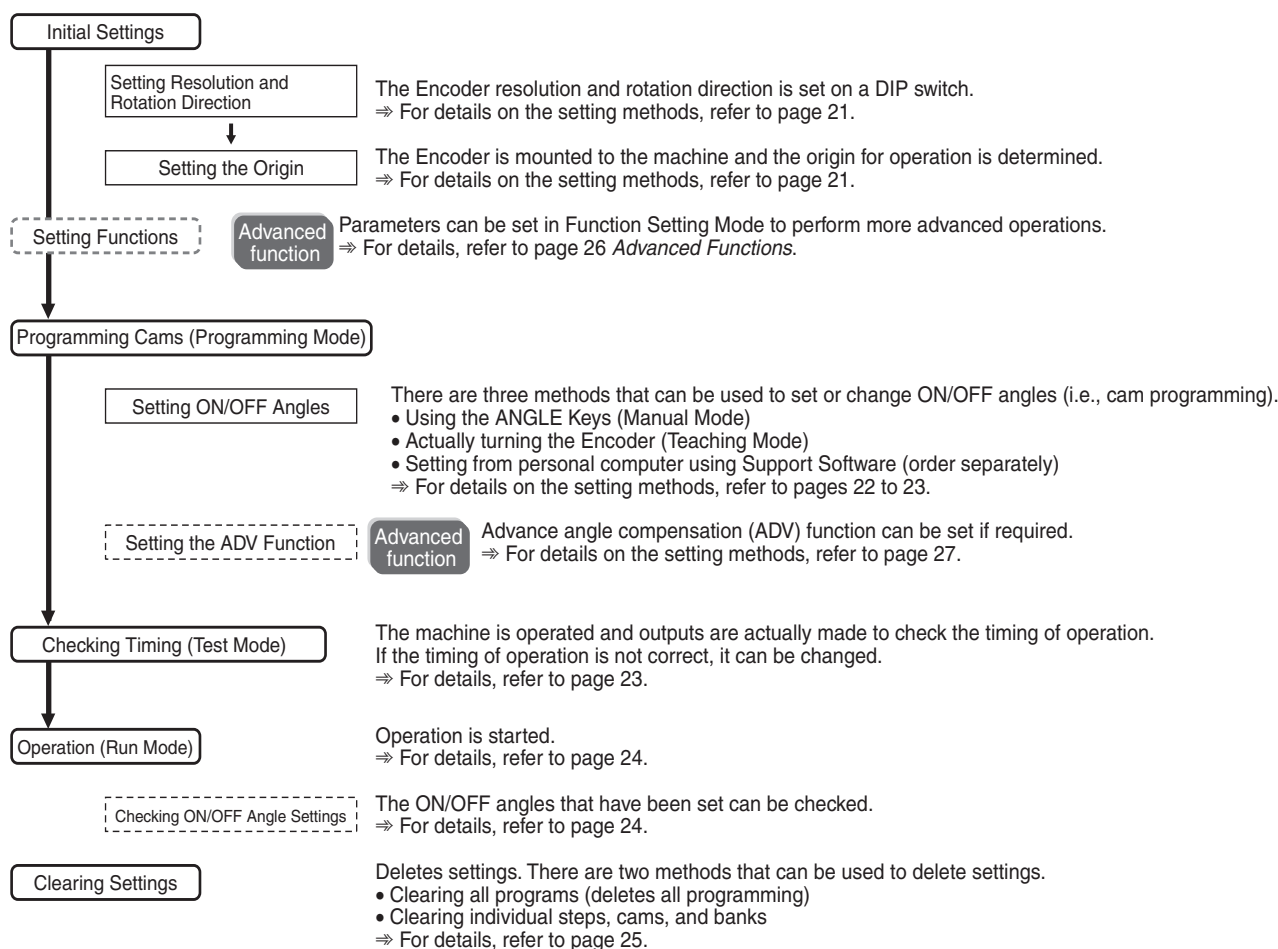

■ Settings for Basic Functions

Changing the Mode

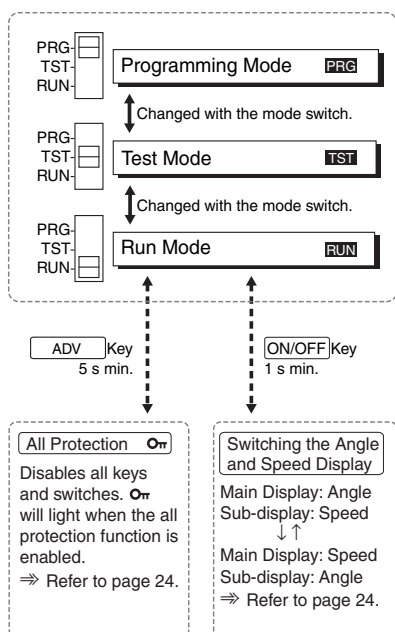

Programming Mode

Used to write cam programs, set the advance angle compensation function, etc. All outputs will remain OFF.

Test Mode

Used to write cam programs, set the advance angle compensation function, and perform other operations while actually turning ON outputs to confirm operation timing. This mode is also used to adjust settings during operation.

Run Mode

Used for normal operation. Settings, such as writing cam programs and setting the advance angle compensation function, cannot be performed.

Setting Resolution and Rotation

Direction

One of three resolutions can be selected for the Encoder connected to the H8PS: 256, 360, or 720. The resolution and display angle are set here.

Turn OFF the power supply.

Set the display angle and the Encoder resolution.

Open the front cover at the lower part of the H8PS and set pins 3 and 4 on the DIP switch.

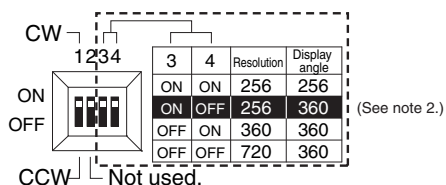

Note 1: Default settings are shown in reverse type.

Note 2: When using an Encoder with a resolution of 256, displaying 360° directly is not possible. The H8PS thus provides a convenient setting that enables converting the display and settings to 360° when using an Encoder with a resolution of 256. When using a 360° display, however, some angles will not be displayed.

Check the rotation direction of the machine (Encoder).

Turn ON the power supply.
Turn the Encoder in the actual direction of operation and confirm that the rotation display monitor turns clockwise. If the monitor turns counterclockwise, turn OFF the power supply and change pin 1 on the DIP switch to CCW.

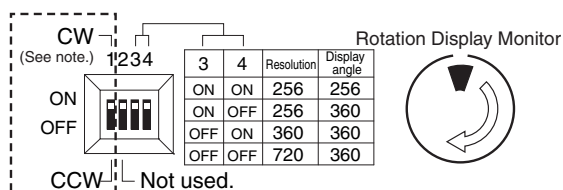

Note: Default setting.

Connect the machine (Encoder) and turn ON the power supply.

End of preparations.

Note: Changes to DIP switch settings are enabled when the power is turned ON.

Setting the Origin

The origin of the Cam Positioner is set to match the origin of the machine (Encoder). The same origin is used for all banks. (The bank function is supported only for 16-/32-output models.)

Example: Setting the Present Angular Position of 150° to 0°

Change the mode. Set the mode switch to PRGM.

Set the programming mode switch. Set the programming mode switch to TCH.

Mode	Programming mode
PRG <input type="checkbox"/>	TCH <input type="checkbox"/>
TST <input type="checkbox"/>	MAN <input type="checkbox"/>
RUN <input type="checkbox"/>	

Set the machine to its origin.

Turn the machine (Encoder) to the position of the desired origin (150° in this example).

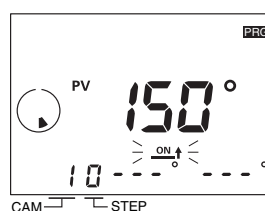

Specify the origin.

Press the **ORIGIN** Key. (See note.)
In approx. 1 s, the present angular position display will change to 0° and the previous display will return.

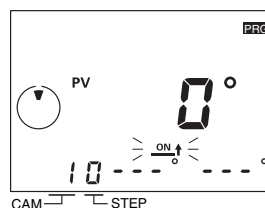

Note: With 16-/32-output models, the origin input from the terminal block can be turned ON to specify the origin.

End

Setting ON/OFF Angles in Manual Mode

ON/OFF angles can be set manually using the ANGLE Keys $\left[\begin{smallmatrix} \uparrow \\ \downarrow \end{smallmatrix} \right]$ on the front of the Cam Positioner.

Example: Setting Step 1 of Cam No. 2 to Turn ON at 28° and Turn OFF at 51°

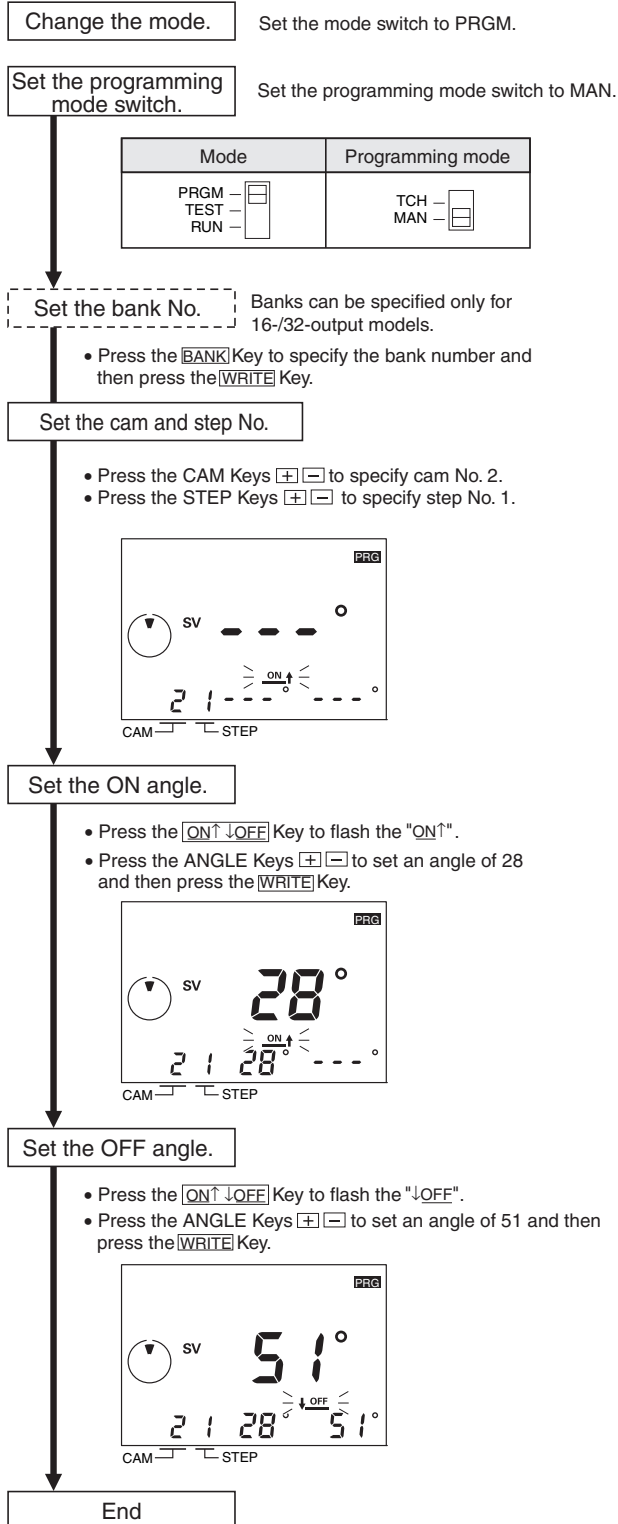

Note: Pressing the $\left[\begin{smallmatrix} \uparrow \\ \downarrow \end{smallmatrix} \right]$ or $\left[\begin{smallmatrix} \uparrow \\ \downarrow \end{smallmatrix} \right]$ Key continually will automatically increment or decrement the value. Pressing the other key during automatic increment or decrement will increase the speed.

Setting ON/OFF Angles in Teaching Mode

ON/OFF angles can be set based on actual machine (Encoder) operation.

Example: Setting the ON/OFF Angles by Teaching Step 2 of Cam No. 3

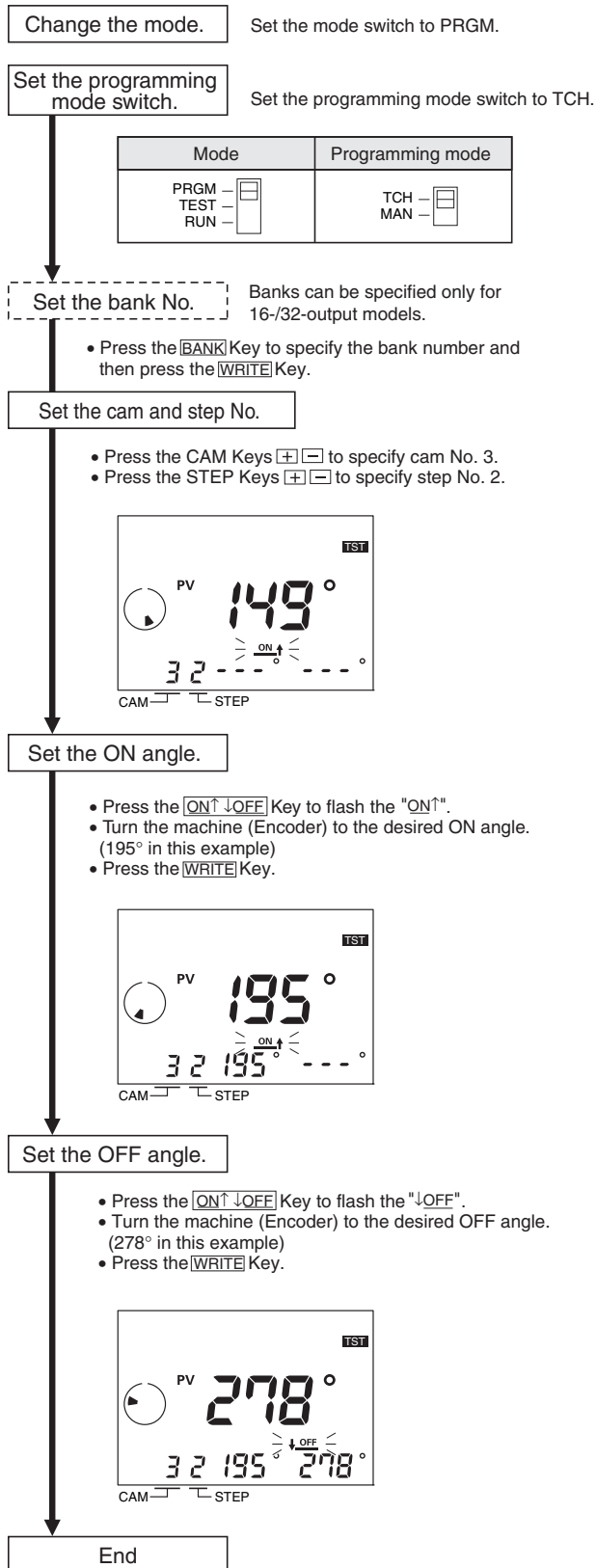

Setting ON/OFF Angles Using Support Software

With 16-/32-output models, programs can be uploaded or downloaded easily with the optional Support Software (H8PS-SOFT-V1) by connecting a personal computer to the Cam Positioner using the USB cable (Recommended USB Cables: ELECOM CO.Ltd. U2C-MF20BK).

Support Software Functions

- Writing cam programs
- Setting functions
- Editing, saving, and printing programs
- Displaying and printing cam program operation charts
- Simple simulations of programs

Applicable OS: Windows 98, 2000, ME, or XP

Refer to the user's manual for the Support Software for details.

Checking Timing (Test Mode)

Testing Operation

Operation can be tested to check operation timing.

- Set the mode switch to TEST.

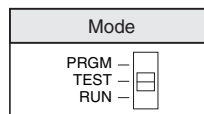

- Operate the Encoder and check the timing of operation.

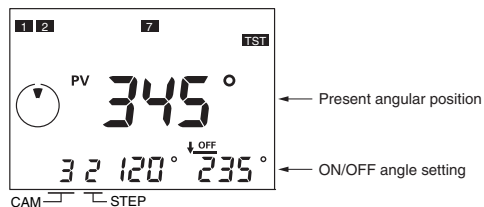

- If the timing is not correct, change the ON/OFF angle settings. The settings can be changed in Test Mode.

Note: 1. Outputs will turn ON and OFF in Test Mode. Confirm system safety before switching to Test Mode.

2. With 16-/32-output model, be sure to turn ON the start input. Outputs are not turned ON unless the start input is turned ON.

Operation (Run Mode)

Starting Operation

- Set the mode switch to RUN to start operation.

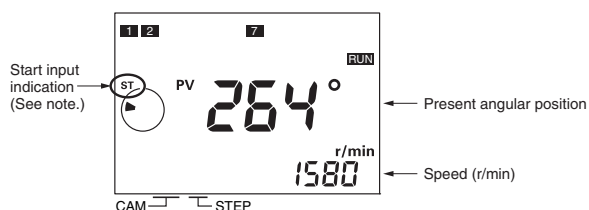
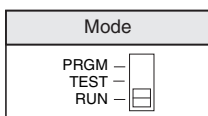

Note: For 16/32-output models, be sure that the start input is ON and that the start input indicator is lit. Outputs (including the cam, pulse, and run outputs) will not function if the start input is OFF. The 8-output models do not have a start input.

Switching the Angle and Speed Displays

- Press the **ON↑/OFF↓** Key for at least 1 s in Run Mode to reverse the display positions of the present angular position and speed (r/min) between main display and sub-display.

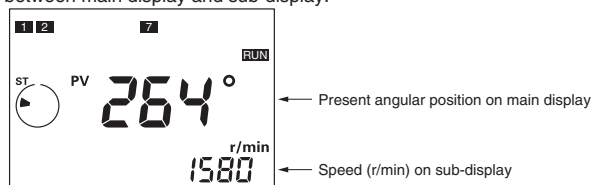

Press the **ON↑/OFF↓** Key for 1 s min.

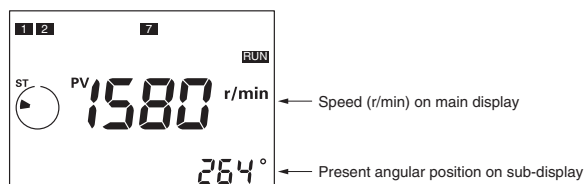

All Protection Function

The all protection function locks the H8PS in Run Mode and prohibits any changes to settings. It can be used to prevent incorrect or unauthorized operation. If the **ADV** Key is pressed for at least 5 s in Run Mode, the All Protection indicator **On RUN** will light on the display and all keys and switches will be disabled. If the mode switch is changed to Programming or Test Mode while protection is enabled, the All Protection indicator **On RUN** will flash to indicate that settings cannot be changed. If a setting on the DIP switch is changed while protection is enabled, the All Protection indicator **On RUN** will flash when the power supply is turned ON to indicate that settings cannot be changed.

All Protection Function Disabled (Normal Operation)

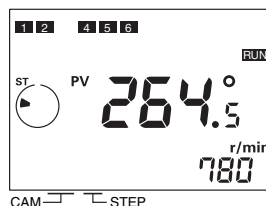

Press the **ADV** Key for 5 s min.

All Protection Function Enabled

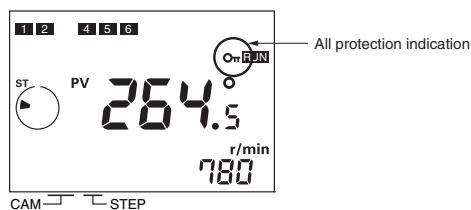

Checking ON/OFF Angle Settings

- During Run Mode, the CAM Keys **+** **-** and STEP Keys **+** **-** can be used to check the ON/OFF angle settings for any step. Also, the **CHECK** Key can be pressed to check the ON/OFF angle settings in order for all steps starting from cam 1. If there is no key operation for 10 s or longer during the checking operation, the previous display will be resumed.

Clearing Settings

Clearing All Programs

The all clear function can be used to delete all cam programs, the settings for advance angle compensation function, and all other settings. All settings in the Function Setting Mode will be returned to their default settings.

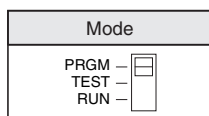

Set the mode switch to PRGM or TEST.

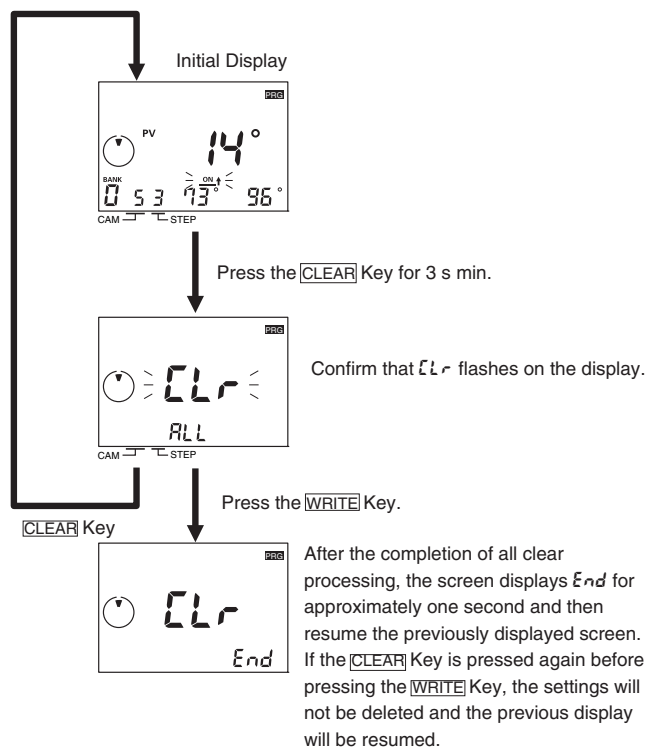

Clearing Individual Steps, Cams, and Banks

ON/OFF angle settings can be deleted by step, by cam, or by bank. If settings are deleted by cam, the settings for the advance angle compensation (ADV) function will not be deleted. If settings are deleted by bank, the settings for the ADV function will also be deleted. Settings in the Function Setting Mode will not be deleted.

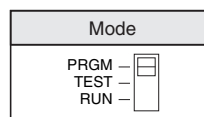

Set the mode switch to PRGM or TEST.

