



Chipsmall Limited consists of a professional team with an average of over 10 year of expertise in the distribution of electronic components. Based in Hongkong, we have already established firm and mutual-benefit business relationships with customers from,Europe,America and south Asia,supplying obsolete and hard-to-find components to meet their specific needs.

With the principle of "Quality Parts,Customers Priority,Honest Operation,and Considerate Service",our business mainly focus on the distribution of electronic components. Line cards we deal with include Microchip,ALPS,ROHM,Xilinx,Pulse,ON,Everlight and Freescale. Main products comprise IC,Modules,Potentiometer,IC Socket,Relay,Connector.Our parts cover such applications as commercial,industrial, and automotives areas.

We are looking forward to setting up business relationship with you and hope to provide you with the best service and solution. Let us make a better world for our industry!



## Contact us

Tel: +86-755-8981 8866 Fax: +86-755-8427 6832

Email & Skype: info@chipsmall.com Web: www.chipsmall.com

Address: A1208, Overseas Decoration Building, #122 Zhenhua RD., Futian, Shenzhen, China



SJ116694  
(DRAWING NO.)

版数 VER.	年月日 DATE	CN NO.	変更内容 DESCRIPTION	製図 DR.	担当 CHK.	査閲 APPD.	承認 APPD.
2	04/JAN/2017	019866	CORRECTION OF ERRORS 誤記訂正	—	K. NAKAZAWA	—	T. KUDOU

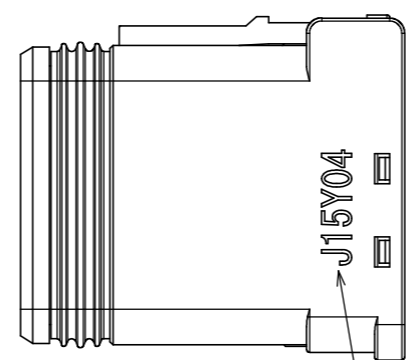
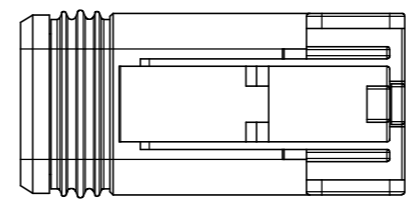
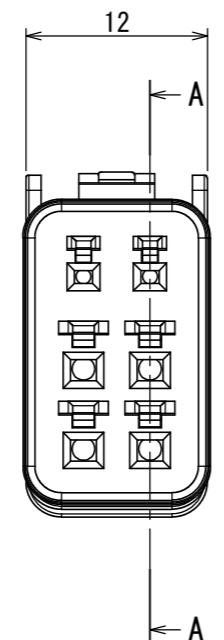
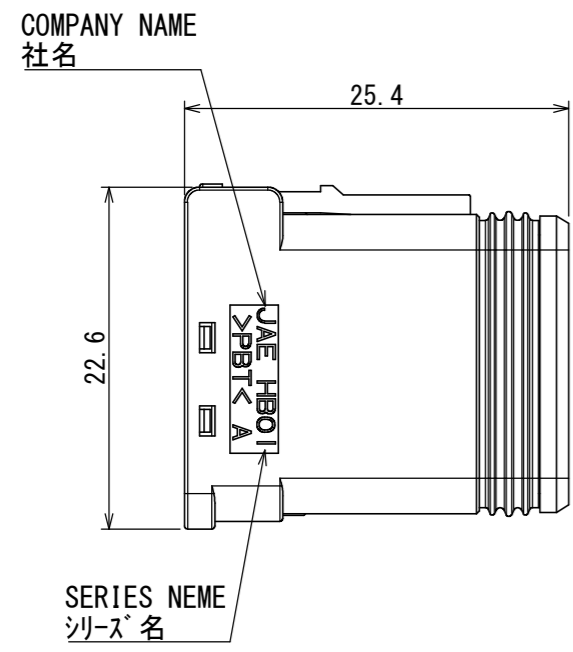

PRODUCTION DATE  
製造日

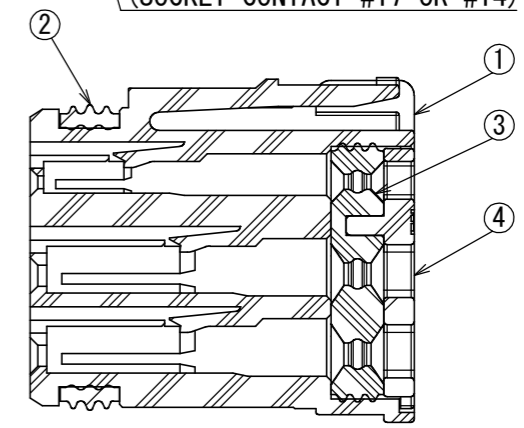
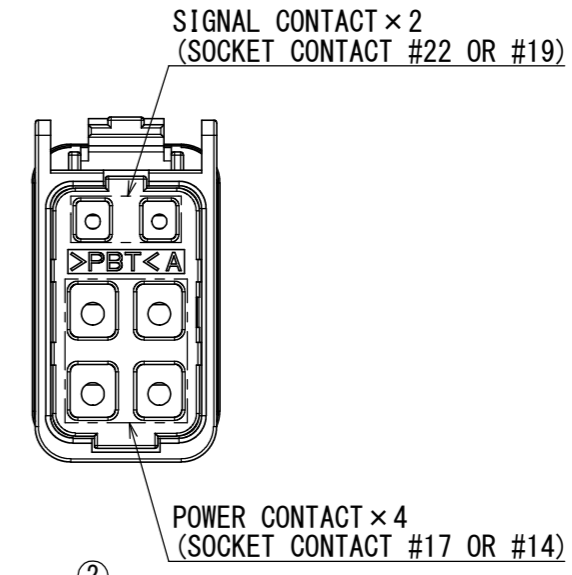

A-A  
(2 : 1)

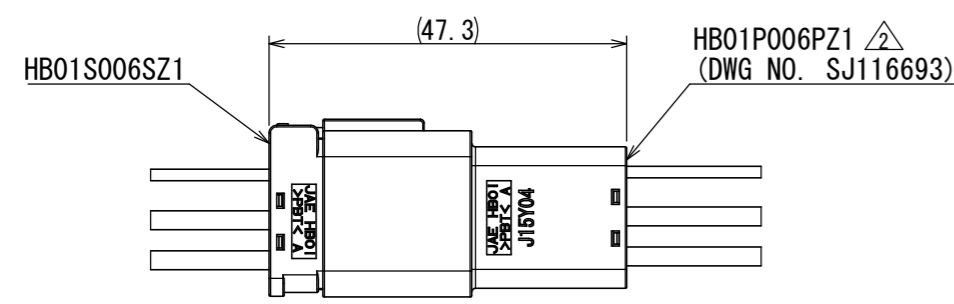

CONNECTOR MATING STATE  
コネクタ嵌合状態

NOTE 1. APPLICABLE CONTACTS ARE SHOWN.  
THE CONTACTS ARE SOLD SEPARATELY. (REFER TO TABLE 1)

注1. 適用コネクタを示す。コネクタは別売りである。(表1参照)

TABLE 1. APPLICABLE CONTACTS (NOTE 1)

NO.	PRODUCT NAME 名称	DRAWING NO. 図番	CONTACT TYPE コネクタ種別	APPLICABLE CABLE 適用電線	
				WIRE SIZE 電線サイズ	INSULATION DIA. 被覆外径
1	HB01S06K4P1	SJ116697	SOCKET CONTACT #22	AWG#22~24	φ0.9~1.5
2	HB01S06K4P2	SJ116698	SOCKET CONTACT #19	AWG#19~21	φ1.2~1.8
3	HB01S25H3P1	SJ116701	SOCKET CONTACT #17	AWG#17~19	φ1.6~2.3
4	HB01S25H2P1	SJ116702	SOCKET CONTACT #14	AWG#14~16	φ2.1~2.8

符号 NO.	名称 DESCRIPTION	個数 QTY.	材料 MATERIAL	仕上 FINISH	備考 REMARKS
4	COVER	1	PBT	COLOR: NATURAL	
3	GROMMET	1	SILICONE RUBBER	COLOR: BROWN	
2	SEAL RING	1	SILICONE RUBBER	COLOR: BROWN	
1	INSULATOR	1	PBT	COLOR: BLACK	

仕様書 (SPECIFICATION) JACS-11114 (-*)	第1版 (ORIGINAL DATE) 04/DEC/2015	尺度 (SCALE) 2:1	シリーズ (SERIES) HB01	日本航空電子工業株式会社 JAE
一般公差 (GENERAL TOLERANCE) 寸法 (DIMENSION)	製図 DR.	名称 (TITLE) HB01S006SZ1	日本航空電子工業株式会社 JAE	図面番号 (DRAWING NO.) SJ116694
× ±0.8 ×× ±0.4 ××× ±0.1 ×××× ±	担当 CHK. 査閲 APPD. 承認 APPD.	SOCKET CONNECTOR	JAPAN AVIATION ELECTRONICS INDUSTRY, LTD.	
角度 (ANGLES) ×° ± ×°×' ±	単位 (UNIT) : mm	質量 (MASS) 6.6g	版数 (VER.) 2	

DCF-C-212H(12.08)

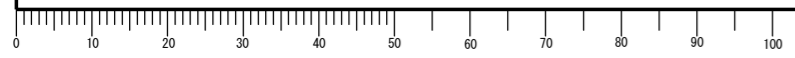

WISDOM承認 2017/01/05