



Chipsmall Limited consists of a professional team with an average of over 10 year of expertise in the distribution of electronic components. Based in Hongkong, we have already established firm and mutual-benefit business relationships with customers from,Europe,America and south Asia,supplying obsolete and hard-to-find components to meet their specific needs.

With the principle of “Quality Parts,Customers Priority,Honest Operation,and Considerate Service”,our business mainly focus on the distribution of electronic components. Line cards we deal with include Microchip,ALPS,ROHM,Xilinx,Pulse,ON,Everlight and Freescale. Main products comprise IC,Modules,Potentiometer,IC Socket,Relay,Connector.Our parts cover such applications as commercial,industrial, and automotives areas.

We are looking forward to setting up business relationship with you and hope to provide you with the best service and solution. Let us make a better world for our industry!



Contact us

Tel: +86-755-8981 8866 Fax: +86-755-8427 6832

Email & Skype: info@chipsmall.com Web: www.chipsmall.com

Address: A1208, Overseas Decoration Building, #122 Zhenhua RD., Futian, Shenzhen, China



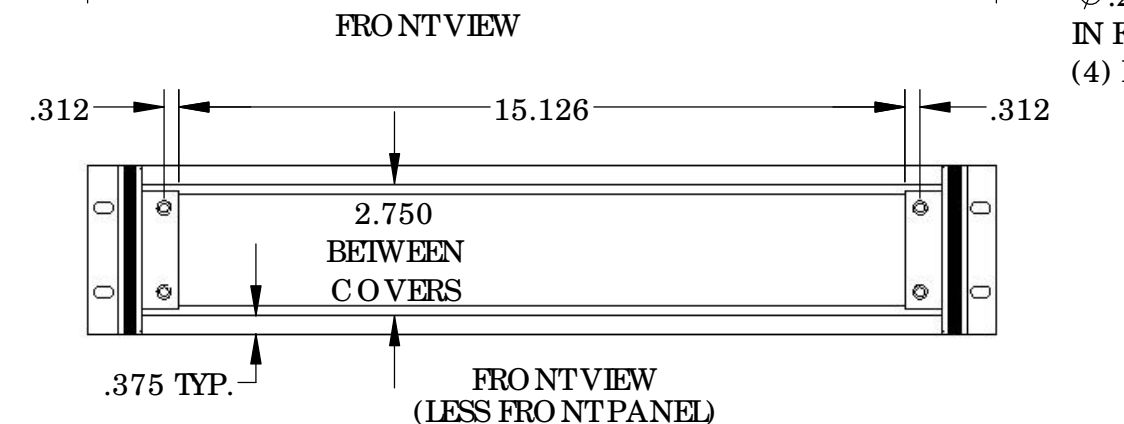
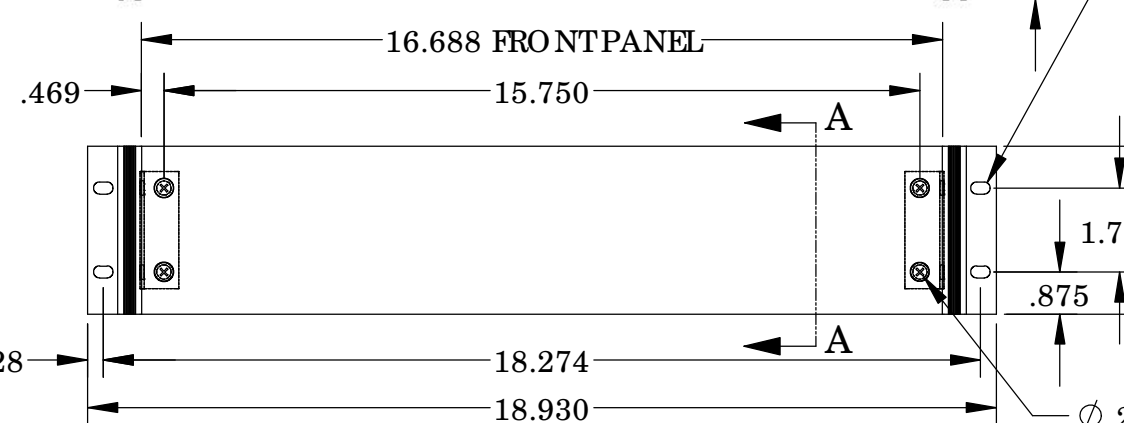
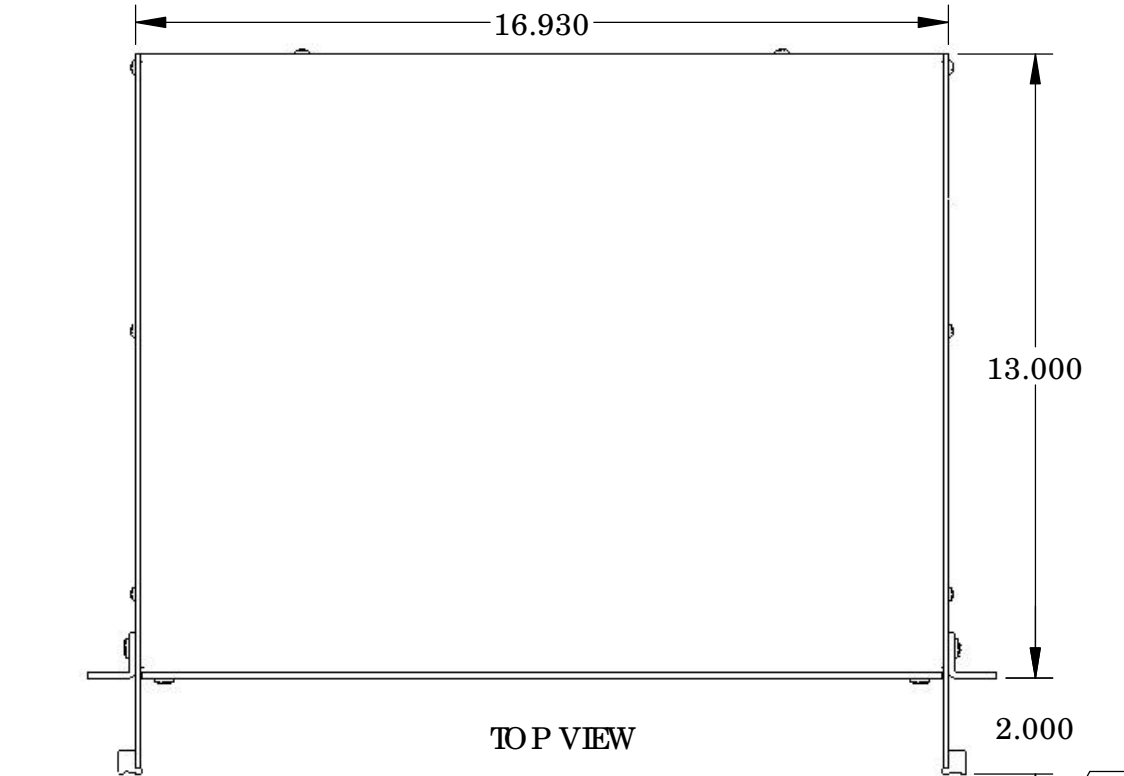
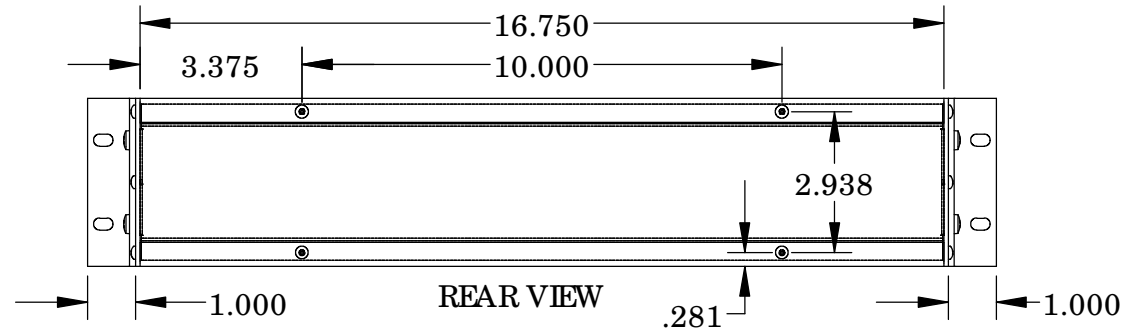

UNIT SHIPPED UNASSEMBLED.

OUTER BRACKETS FOR MOUNTING IN STANDARD 19" WIDE CABINETS.

OPTIONAL SELF-ADHESIVE RUBBER FEET (SUPPLIED)

LOAD RATING: 25 LBS. MAX.

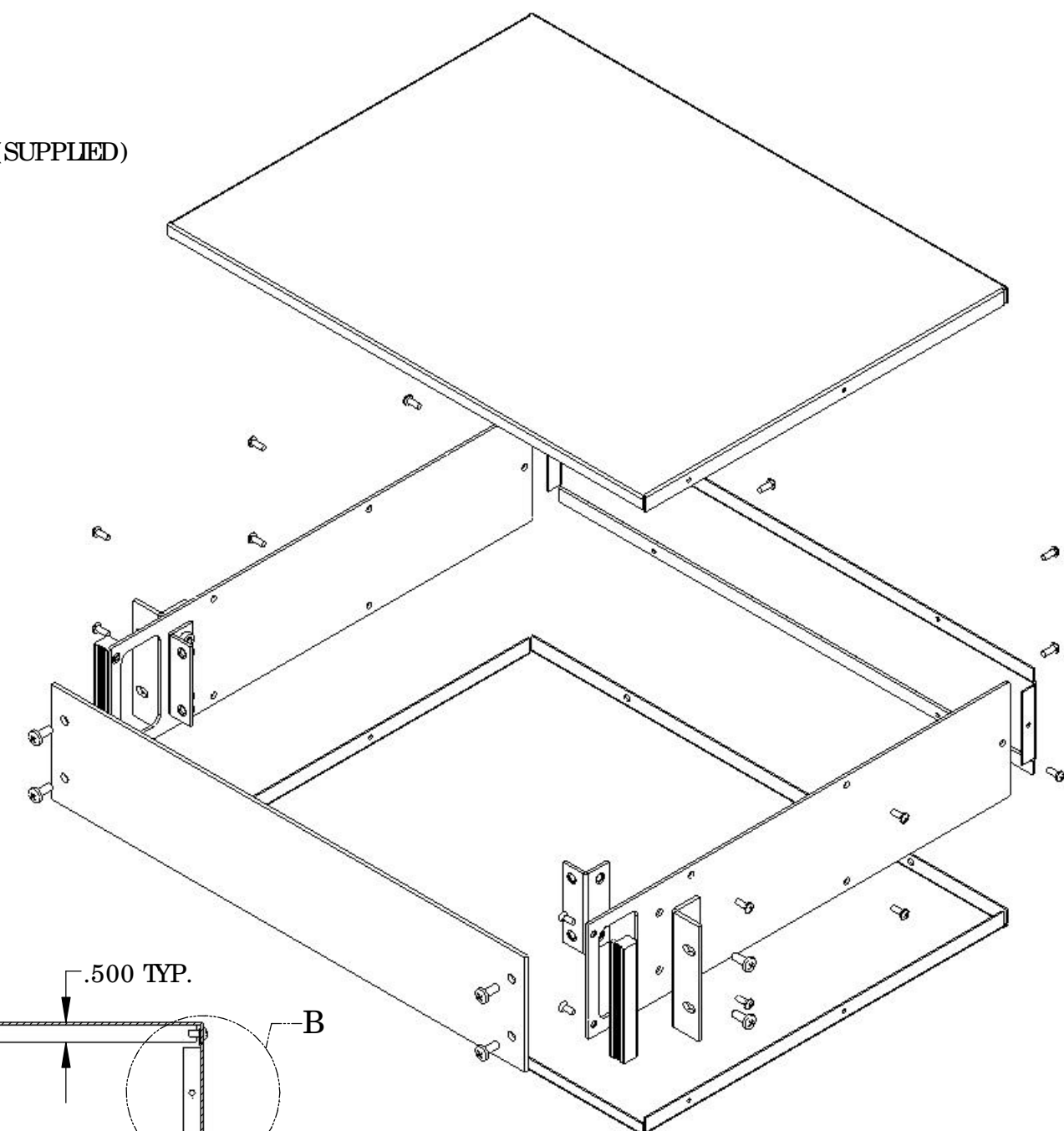
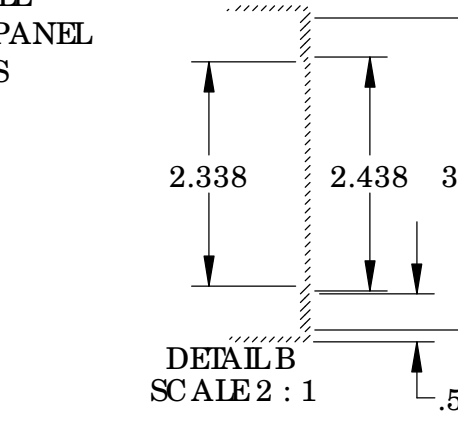
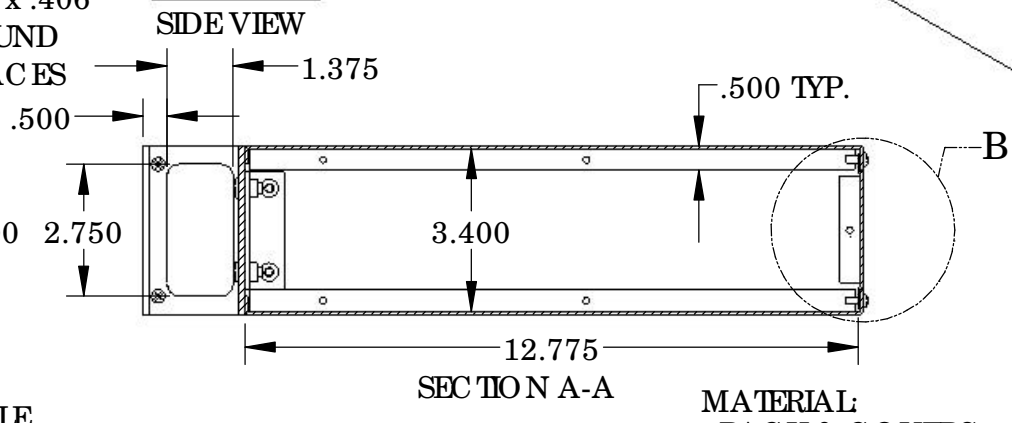
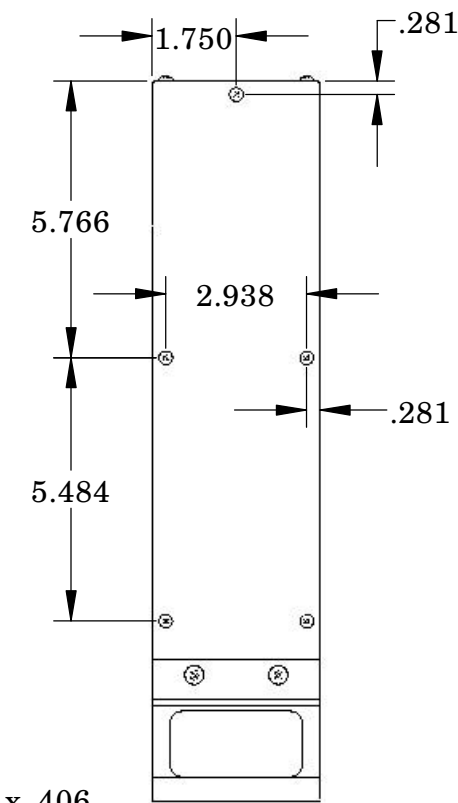

Ø .250 x .406
O BROUND
(4) PLACES

Ø .250 HOLE
IN FRONT PANEL
(4) PLACES

MATERIAL:

BACK & COVERS	0.050 THICK ALUMINUM
SIDES & INNER BRACKETS	0.090 THICK ALUMINUM
FRONT PANEL	0.125 THICK ALUMINUM
OUTER BRACKETS	11 GA. C.R.S.
HANDLE EXTRUSIONS	ALUMINUM

FINISH:

BACK & COVERS	PREPAINTED SMOOTH WHITE
SIDES & OUTER BRACKETS	WHITE TEXTURED
FRONT PANEL	NATURAL (OUTSIDE SURFACE TAPED WITH PVC)
INNER BRACKETS	NATURAL
HANDLE EXTRUSIONS	CAUSTIC ETCH & CLEAR ANODIZED
FEET	BLACK