



Chipsmall Limited consists of a professional team with an average of over 10 year of expertise in the distribution of electronic components. Based in Hongkong, we have already established firm and mutual-benefit business relationships with customers from,Europe,America and south Asia,supplying obsolete and hard-to-find components to meet their specific needs.

With the principle of “Quality Parts,Customers Priority,Honest Operation,and Considerate Service”,our business mainly focus on the distribution of electronic components. Line cards we deal with include Microchip,ALPS,ROHM,Xilinx,Pulse,ON,Everlight and Freescale. Main products comprise IC,Modules,Potentiometer,IC Socket,Relay,Connector.Our parts cover such applications as commercial,industrial, and automotives areas.

We are looking forward to setting up business relationship with you and hope to provide you with the best service and solution. Let us make a better world for our industry!



Contact us

Tel: +86-755-8981 8866 Fax: +86-755-8427 6832

Email & Skype: info@chipsmall.com Web: www.chipsmall.com

Address: A1208, Overseas Decoration Building, #122 Zhenhua RD., Futian, Shenzhen, China



Coiltronics HCM1707 Series

High current power inductors



Product description

- High current carrying capacity
- Magnetically shielded, low EMI
- Frequency range up to 1MHz
- Inductance range from 1.5 μ H to 68.0 μ H
- Current range from 5.2 to 40.0 amps
- 17.5x17.2mm footprint surface mount package in a 7.0mm height
- Powder iron core material
- Halogen free, lead free, RoHS compliant

Applications

- Voltage Regulator Module (VRM)
- Multi-phase regulators
- Point-of-load modules
- Desktop and server VRMs and EVRDs
- Data networking and storage systems
- Base station equipment
- Battery power systems

Environmental data

- Storage temperature range (Component): -55°C to +125°C
- Operating temperature range: -55°C to +125°C (ambient + self-temperature rise)
- Solder reflow temperature: J-STD-020D compliant



Powering Business Worldwide



The Coiltronics brand of magnetics (formerly of the Bussmann Division of Cooper Industries) is now part of Eaton's Electrical Group, Electronics Division.

Coiltronics is now part of Eaton
Same great products plus even more.

Product specifications

Part Number ⁶	OCL ¹ ±20% (μH)	FLL min. ² (μH)	I _{rms} ³ (amps)	I _{sat} ⁴ (amps)	DCR (mΩ) @ 20°C (typical)	DCR (mΩ) @ 20°C (maximum)	K-factor ⁵
HCM1707-1R5-R	1.5	0.96	40	40	1.85	2.15	124
HCM1707-2R2-R	2.2	1.41	37	34	2.15	2.50	103
HCM1707-4R7-R	4.7	3.01	27	24	4.12	4.72	76
HCM1707-6R8-R	6.8	4.35	20	22	6.55	7.55	60
HCM1707-8R2-R	8.2	5.25	16	20	8.10	8.70	55
HCM1707-100-R	10	6.40	14	18	9.30	10	47
HCM1707-150-R	15	9.60	12	13	14.5	15.5	43
HCM1707-220-R	22	14.1	9.5	11	21	23	37
HCM1707-330-R	33	21.1	9.0	10	35	37	28
HCM1707-470-R	47	30.1	6.8	7.5	41	47	25
HCM1707-680-R	68	43.5	5.2	6.5	74	85	20

- Open Circuit Inductance (OCL) Test Parameters: 100kHz, 0.25V_{rms}, 0.0A_{dc}, +25°C.
- Full Load Inductance (FLL): Test parameters: 100kHz, 0.25V_{rms}, I_{sat}, +25°C.
- I_{rms}: DC current for an approximate temperature rise of 40°C without core loss. Derating is necessary for AC currents. PCB layout, trace thickness and width, air-flow, and proximity of other heat generating components will affect the temperature rise. It is recommended that the temperature of the part not exceed +125°C under worst case operating conditions verified in the end application.
- I_{sat}: Peak current for approximately 20% rolloff at +25°C.

- K-factor: Used to determine B_{pp} for core loss (see graph). B_{pp} = K * L * ΔI. B_{pp}:(Gauss), K: (K-factor from table), L: (Inductance in μH), ΔI (Peak to peak ripple current in amps).
- Part Number Definition: HCM1707-yyy-R
 - HCM1707 = Product code and size
 - yyy= Inductance value in uH, R = decimal point,
 if no R is present then third character = number of zeros.
 - "-R" suffix = RoHS compliant

Dimensions - mm

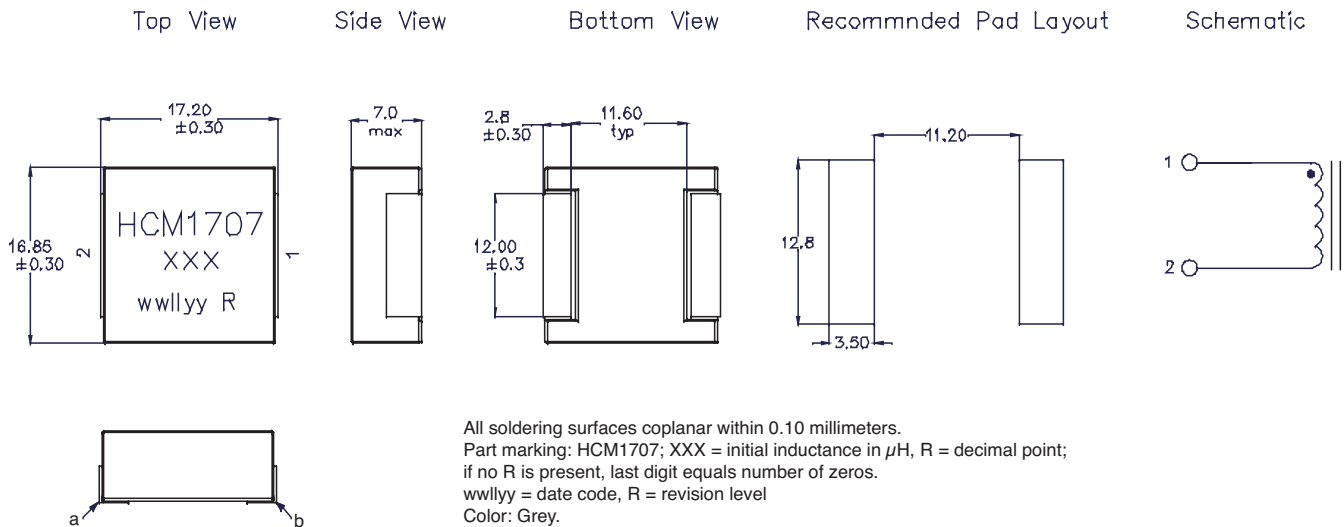

All soldering surfaces coplanar within 0.10 millimeters.
 Part marking: HCM1707; XXX = initial inductance in μH, R = decimal point;
 if no R is present, last digit equals number of zeros.
 wwlyy = date code, R = revision level
 Color: Grey.

DCR measured between point "a" and point "b"

Packaging information - mm

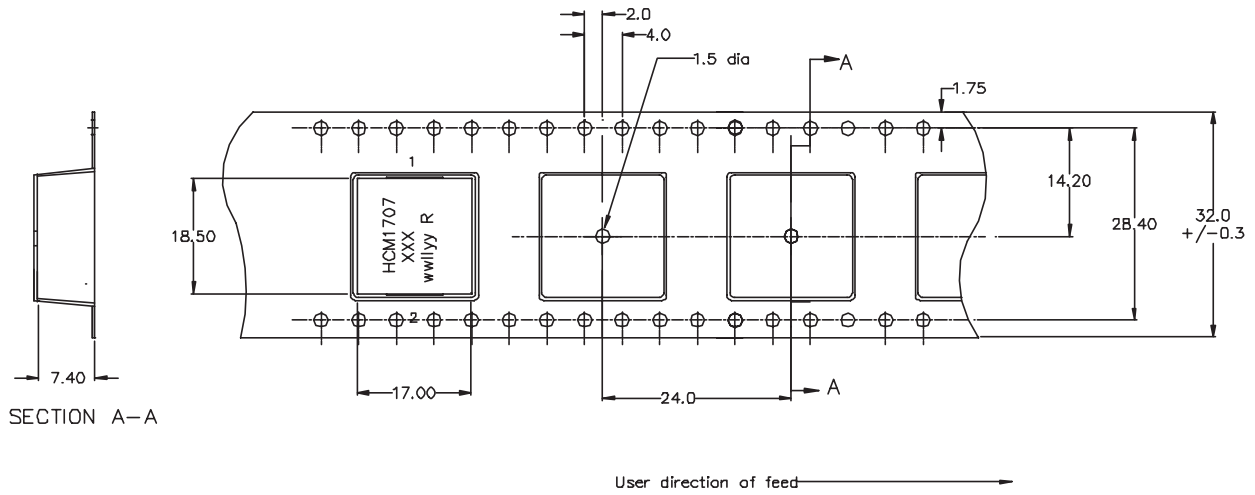

Supplied in tape and reel packaging, 350 parts per 13" diameter reel.

Temperature rise vs. total loss

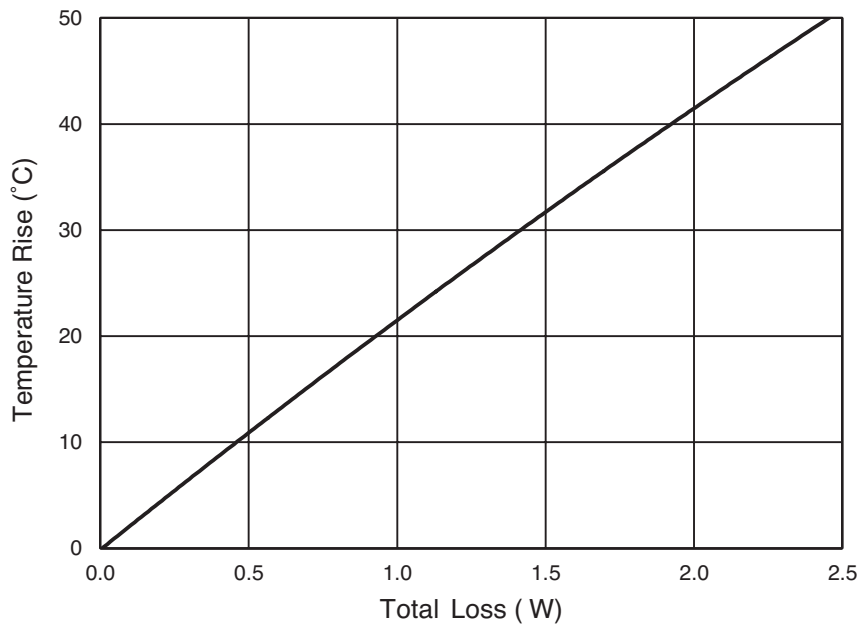

Core loss

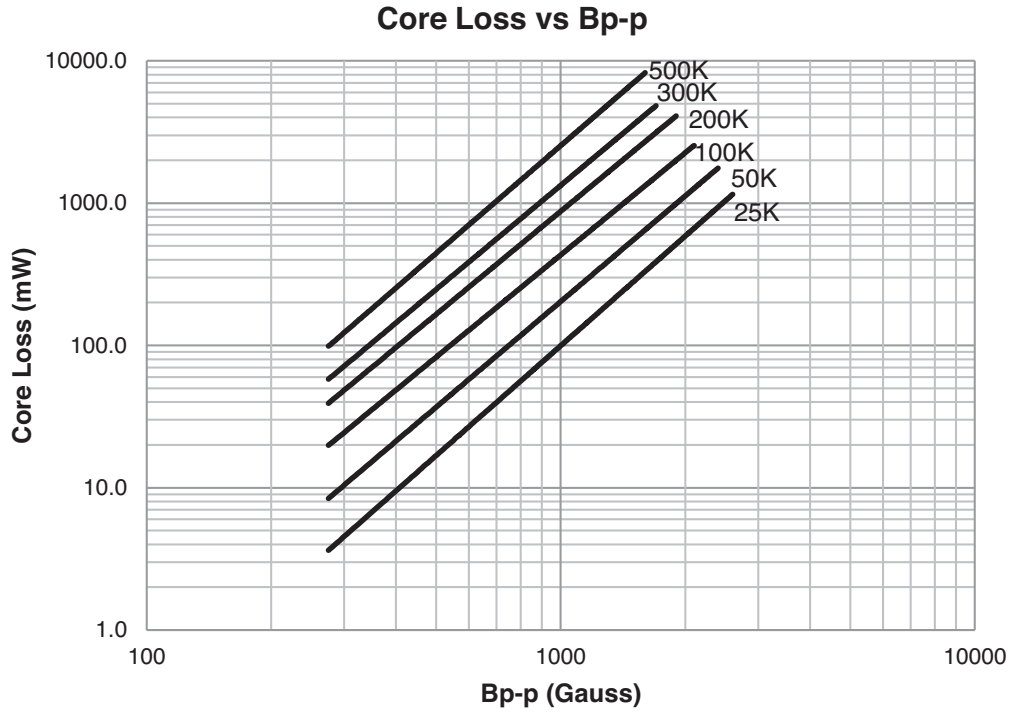

Inductance characteristics

HCM1707-1R5-R

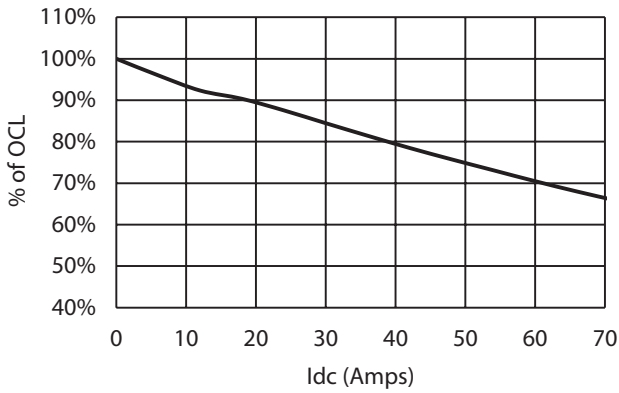

HCM1707-2R2-R

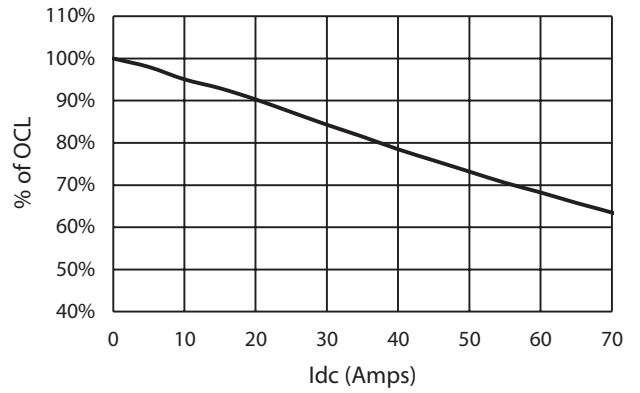

Inductance characteristics

HCM1707-4R7-R

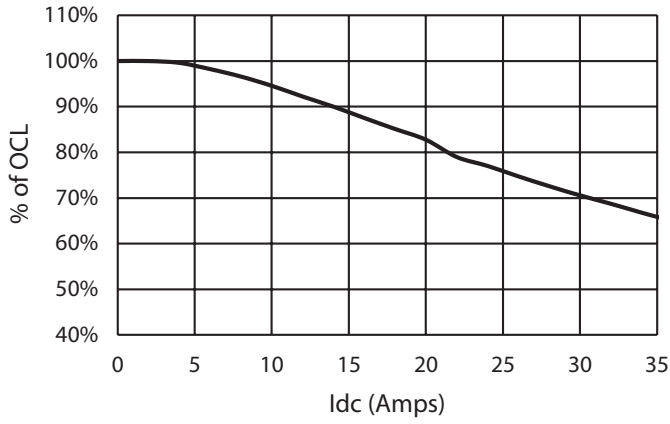

HCM1707-6R8-R

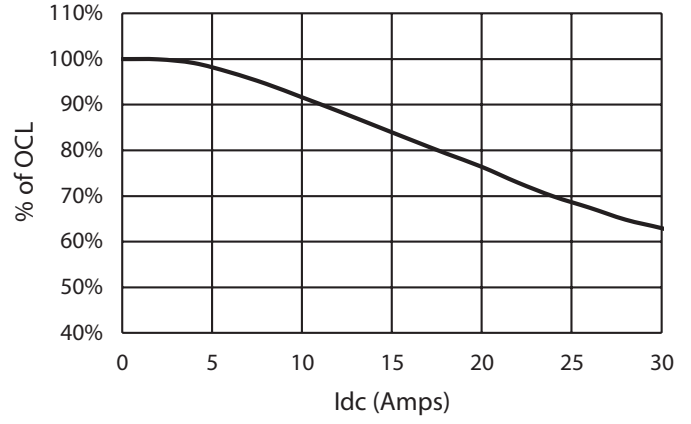

HCM1707-8R2-R

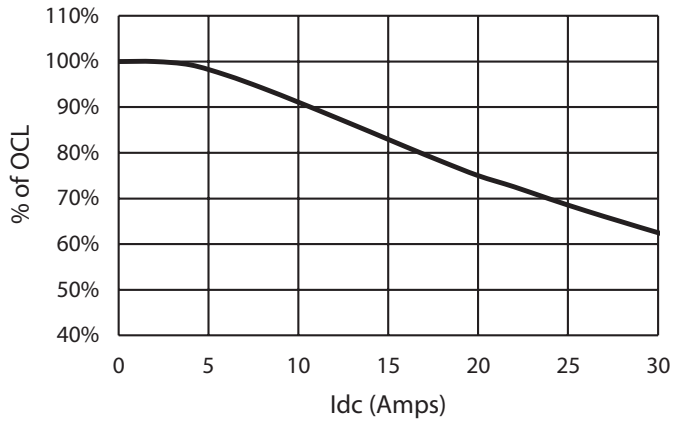

HCM1707-100-R

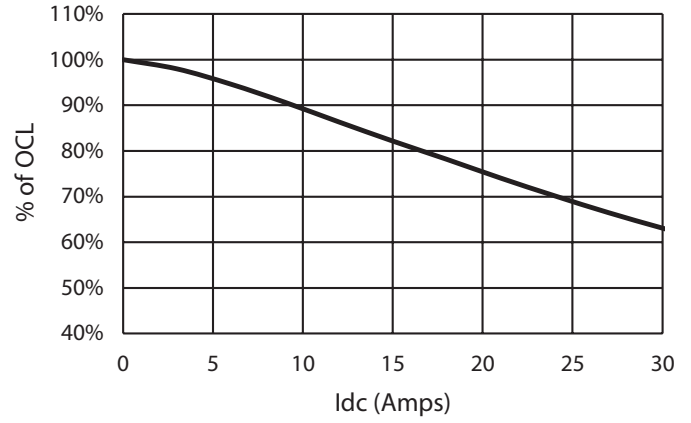

HCM1707-150-R

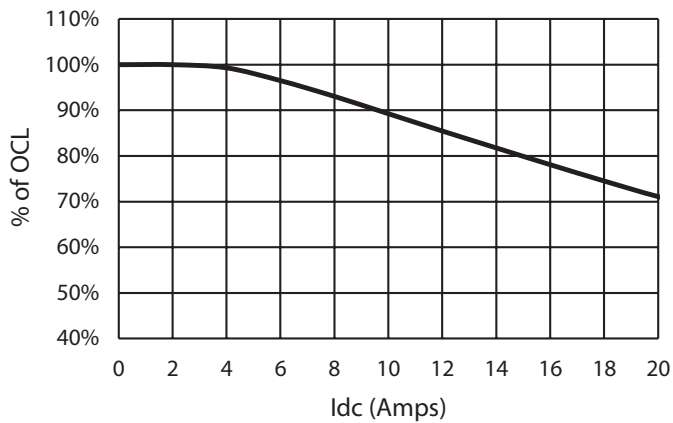

HCM1707-220-R

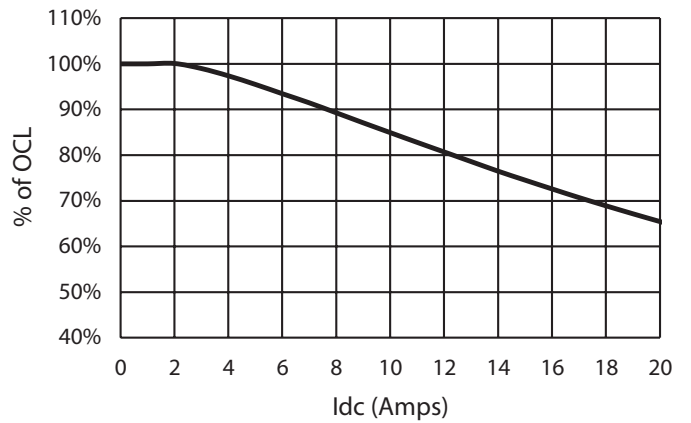

Inductance characteristics

HCM1707-330-R

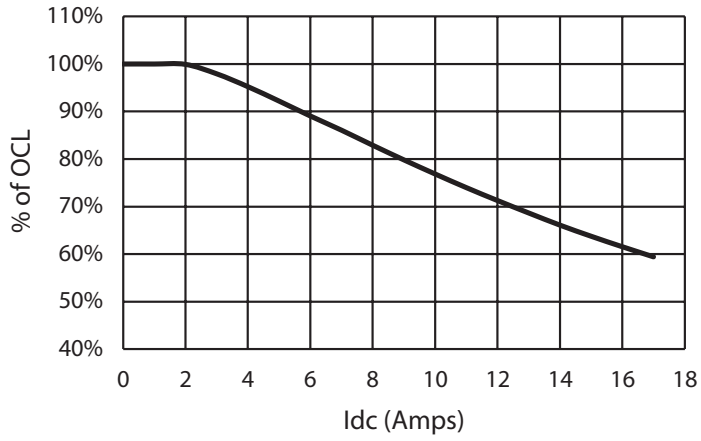

HCM1707-470-R

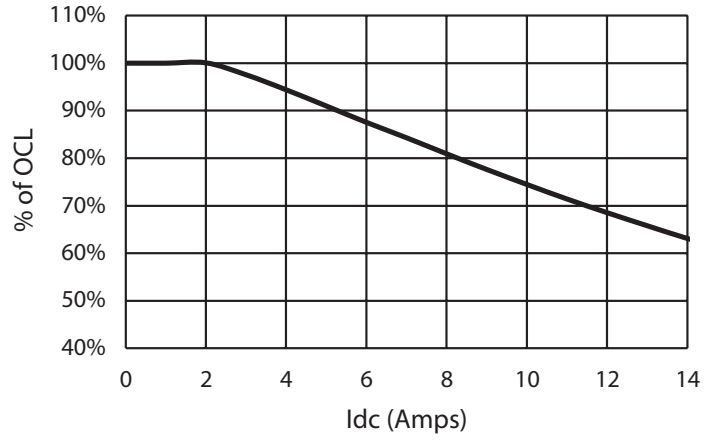

HCM1707-680-R

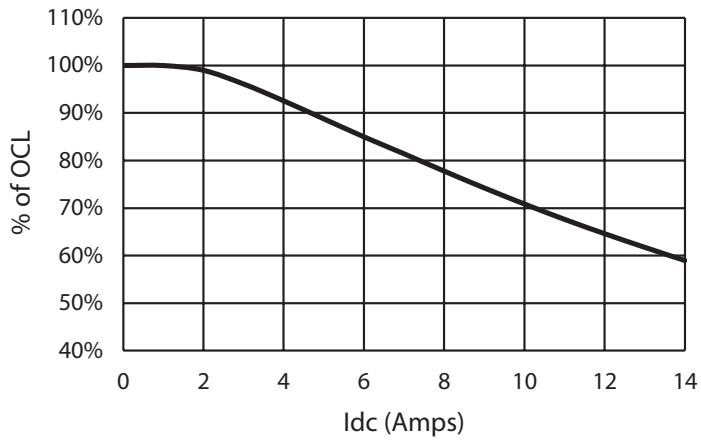

Solder reflow profile

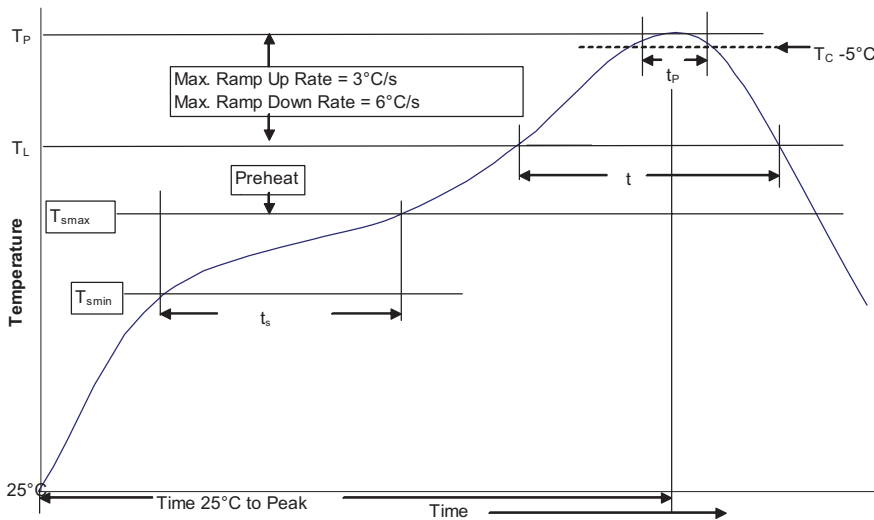

Table 1 - Standard SnPb Solder (T_c)

Package Thickness	Volume mm^3 <350	Volume mm^3 ≥ 350
<2.5mm	235°C	220°C
$\geq 2.5\text{mm}$	220°C	220°C

Table 2 - Lead (Pb) Free Solder (T_c)

Package Thickness	Volume mm^3 <350	Volume mm^3 350 - 2000	Volume mm^3 >2000
<1.6mm	260°C	260°C	260°C
1.6 – 2.5mm	260°C	250°C	245°C
$\geq 2.5\text{mm}$	250°C	245°C	245°C

Reference JEDEC J-STD-020D

Profile Feature	Standard SnPb Solder	Lead (Pb) Free Solder
Preheat and Soak	<ul style="list-style-type: none"> Temperature min. (T_{smin}) Temperature max. (T_{smax}) Time (T_{smin} to T_{smax}) (t_s) 	<ul style="list-style-type: none"> 150°C 200°C 60-120 Seconds
Average ramp up rate T_{smax} to T_p	3°C/ Second Max.	3°C/ Second Max.
Liquidous temperature (T_L)	183°C	217°C
Time at liquidous (t_L)	60-150 Seconds	60-150 Seconds
Peak package body temperature (T_p)*	Table 1	Table 2
Time (t_p ** within 5 °C of the specified classification temperature (T_c))	20 Seconds**	30 Seconds**
Average ramp-down rate (T_p to T_{smax})	6°C/ Second Max.	6°C/ Second Max.
Time 25°C to Peak Temperature	6 Minutes Max.	8 Minutes Max.

* Tolerance for peak profile temperature (T_p) is defined as a supplier minimum and a user maximum.

** Tolerance for time at peak profile temperature (t_p) is defined as a supplier minimum and a user maximum.

North America

Eaton's Electrical Group
Electronics Division
1225 Broken Sound Parkway NW
Suite F
Boca Raton, FL 33487-3533
Tel: 1-561-998-4100
Fax: 1-561-241-6640
Toll Free: 1-888-414-2645

Eaton's Electrical Group
Electronics Division
P.O. Box 14460
St. Louis, MO 63178-4460
Tel: 1-636-394-2877
Fax: 1-636-527-1607

Europe

Eaton's Electrical Group
Electronics Division
Burton-on-the-Wolds
Leicestershire, LE 12 5th UK
Phone: +44 (0) 1509 882 600
Fax: +44 (0) 1509 882 786

Eaton's Electrical Group
Electronics Division
Avda Santa Eulalia, 290
Terrassa, Barcelona 08223 Spain
Phone: +34-93-736-2813
Fax: +34-93-783-5055

Asia Pacific

Eaton's Electrical Group
Electronics Division
No.2, #06-01
Serangoon North Avenue 5
Singapore 554911
Tel: +65 6645 9888
Fax: +65 6728 3155

The only controlled copy of this Data Sheet is the electronic read-only version located on the Bussmann Network Drive. All other copies of this document are by definition uncontrolled. This bulletin is intended to clearly present comprehensive product data and provide technical information that will help the end user with design applications. Bussmann reserves the right, without notice, to change design or construction of any products and to discontinue or limit distribution of any products. Bussmann also reserves the right to change or update, without notice, any technical information contained in this bulletin. Once a product has been selected, it should be tested by the user in all possible applications. Life Support Policy: Bussmann does not authorize the use of any of its products for use in life support devices or systems without the express written approval of an officer of the Company. Life support systems are devices which support or sustain life, and whose failure to perform, when properly used in accordance with instructions for use provided in the labeling, can be reasonably expected to result in significant injury to the user.

**Eaton's Electrical Group
Electronics Division**
114 Old State Road
Ellisville, MO 63021
United States
www.eaton.com/elx



Powering Business Worldwide

© 2014 Eaton
All Rights Reserved
Publication No. 10295 — BU-SB14600
August 2014

Eaton is a registered trademark.

All other trademarks are property of their respective owners.

www.eaton.com/elx