



Chipsmall Limited consists of a professional team with an average of over 10 year of expertise in the distribution of electronic components. Based in Hongkong, we have already established firm and mutual-benefit business relationships with customers from,Europe,America and south Asia,supplying obsolete and hard-to-find components to meet their specific needs.

With the principle of “Quality Parts,Customers Priority,Honest Operation,and Considerate Service”,our business mainly focus on the distribution of electronic components. Line cards we deal with include Microchip,ALPS,ROHM,Xilinx,Pulse,ON,Everlight and Freescale. Main products comprise IC,Modules,Potentiometer,IC Socket,Relay,Connector.Our parts cover such applications as commercial,industrial, and automotives areas.

We are looking forward to setting up business relationship with you and hope to provide you with the best service and solution. Let us make a better world for our industry!



Contact us

Tel: +86-755-8981 8866 Fax: +86-755-8427 6832

Email & Skype: info@chipsmall.com Web: www.chipsmall.com

Address: A1208, Overseas Decoration Building, #122 Zhenhua RD., Futian, Shenzhen, China



NOTES:

1. ROHS COMPLIANT
2. HEADER: DAP (DIALLYL PHTHALATE) WITH FLAMMABILITY RATING UL 94V-0 OR BETTER.
3. DESIGNED TO SUPPORT HD-BASET AND TESTED WITH VALENS CHIPSET
4. STORAGE TEMPERATURE: -20°C TO +125°C
5. COMPLIANCE TO J-STD:
 - A. J-STD-002: SOLDERABILITY AT 245°C REFLOW PROFILE
 - B. J-STD-020: LEVEL 1, NO MOISTURE SENSITIVE
 - C. J-STD-075: R7, 245°C MAXIMUM THROUGH REFLOW SOLDER
6. TO ORDER TAPE & REEL PACKAGING ADD A "T" SUFFIX TO THE PART NUMBER(i.e HD8008NL BECOMES HD8008NLT).

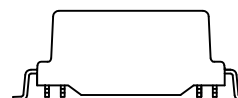
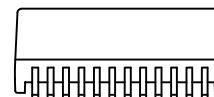
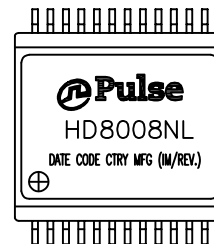

FINAL OUTLINE

© Copyright, 2015. Pulse Electronics Corp. All rights reserved. Pulse confidential & proprietary. (12/15/15)

PRODUCT DESCRIPTION	TLA DRAWING	PS DRAWING	SHEET	PART NO.	DATASHEET REV.
MDL,SIN,HDBT,1:1,PoEP,SM,TU	HD8008NL-P1	PS-2517.001-A	1 OF 3	HD8008NL	C

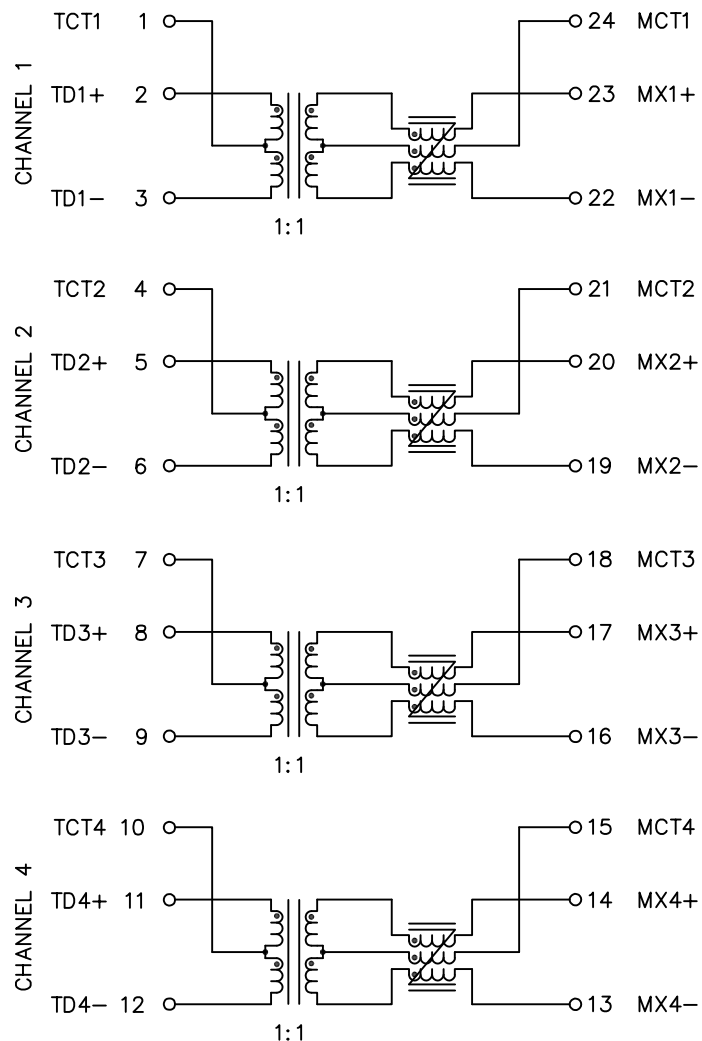

SCHEMATIC

ELECTRICAL CHARACTERISTICS AT +25°C UNLESS OTHER SPECIFIED
MEETS HDBASET SPECIFICATION

PARAMETER	SPECIFICATIONS		
OPERATING TEMPERATURE	0°C TO 70°C		
TURNS RATIO	1.00 ± 2%		
POLARITY	PER SCHEMATIC		
INSERTION LOSS	100 KHz	1-400 MHz	500 MHz
	-3.0 dB MAX	-1.5 dB MAX (-1.0 dB TYP)	-3.0 dB MAX
RETURN LOSS (Z OUT = 100 OHM ± 1%)	1-40 MHz	40 MHz-500 MHz	
	-18 dB MIN	-17 + 10*LOG (f/40)	
INDUCTANCE (OCL)	100 uH MIN (MEASURED AT 100 KHz, 100 mVRMS AND WITH 5 mA DC BIAS)		
CROSSTALK, ADJACENT CHANNELS	1-100 MHz	100-500 MHz	
	-40 dB MIN	-30 dB MIN	
COMMON MODE REJECTION RATIO	1-100 MHz	100-300 MHz	300-500 MHz
	-35 dB MIN	-30 dB MIN	-25 dB MIN
	COMMON TO DIFFERENTIAL MODE REJECTION (CDMR)		
	1-250 MHz	250-500 MHz	
	-30 dB MIN	-22 dB MIN	
DC CURRENT/VOLTAGE RATING	TOTAL 600 mA MAX @ 57 V (CONTINUOUS) OR 300 mA MAX/PAIR @ 57 V (CONTINUOUS)		
INPUT - OUTPUT ISOLATION	1500 VRMS MIN @ 60 SECONDS		

NOTE: f IS FREQUENCY IN MHZ.

© Copyright, 2015. Pulse Electronics Corp. All rights reserved. Pulse confidential & proprietary. (12/15/15)

PRODUCT DESCRIPTION	TLA DRAWING	PS DRAWING	SHEET	PART NO.	DATASHEET REV.
MDL,SIN,HDBT,1:1,PoEP,SM,TU	HD8008NL-P1	PS-2517.001-A	2 OF 3	HD8008NL	C

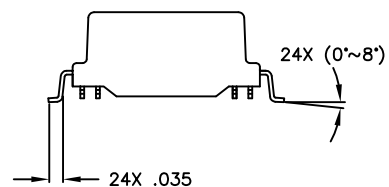
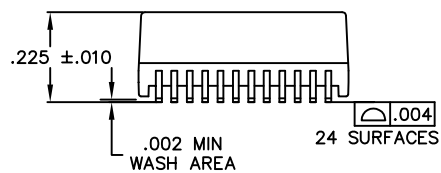
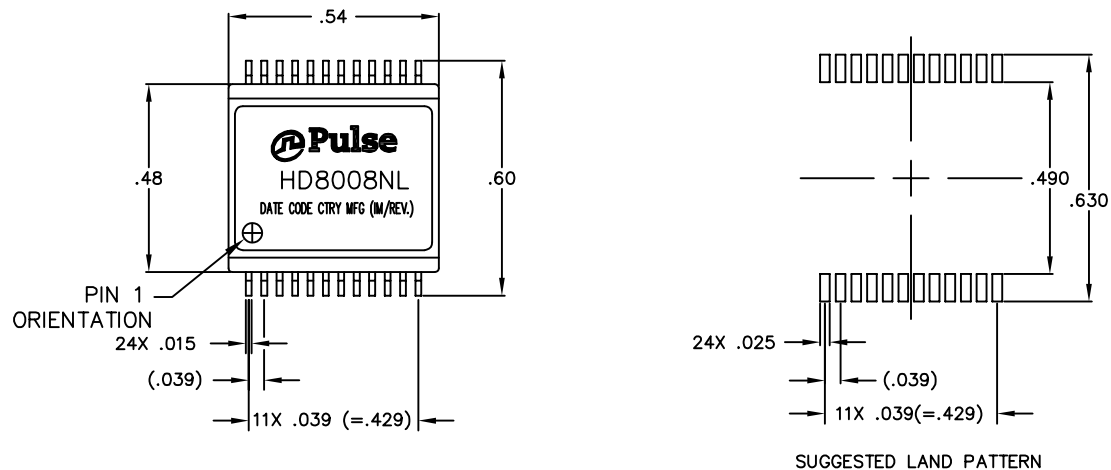

DIMENSIONS ARE IN INCHES WITH THE FOLLOWING,
TOLERANCES:
.XX = $\pm .02$.XXX = $\pm .010$

© Copyright, 2015. Pulse Electronics Corp. All rights reserved. Pulse confidential & proprietary. (12/15/15)

PRODUCT DESCRIPTION	TLA DRAWING	PS DRAWING	SHEET	PART NO.	DATASHEET REV.
MDL,SIN,HDBT,1:1,PoEP,SM,TU	HD8008NL-P1	PS-2517.001-A	3 OF 3	HD8008NL	C