



Chipsmall Limited consists of a professional team with an average of over 10 year of expertise in the distribution of electronic components. Based in Hongkong, we have already established firm and mutual-benefit business relationships with customers from,Europe,America and south Asia,supplying obsolete and hard-to-find components to meet their specific needs.

With the principle of “Quality Parts,Customers Priority,Honest Operation,and Considerate Service”,our business mainly focus on the distribution of electronic components. Line cards we deal with include Microchip,ALPS,ROHM,Xilinx,Pulse,ON,Everlight and Freescale. Main products comprise IC,Modules,Potentiometer,IC Socket,Relay,Connector.Our parts cover such applications as commercial,industrial, and automotives areas.

We are looking forward to setting up business relationship with you and hope to provide you with the best service and solution. Let us make a better world for our industry!



Contact us

Tel: +86-755-8981 8866 Fax: +86-755-8427 6832

Email & Skype: info@chipsmall.com Web: www.chipsmall.com

Address: A1208, Overseas Decoration Building, #122 Zhenhua RD., Futian, Shenzhen, China



Data Sheet

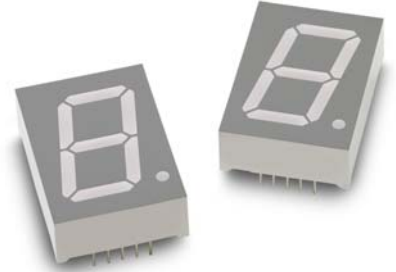

Description

The HDSP-H1x1/H1x3 is a 1.0 inch high, single-digit display series. These halogenated devices utilize AlInGaP red, green and deep red chips. This device is halogenated.

All devices are categorized for luminous intensity. The green device is categorized for color. Use of similar device categories yields a uniform display.

Features

- High reliability
- Excellent characters appearance
- Available in CA and CC
- RoHS Compliant
- Gray top surface with white diffused segments.

Table 1 Ordering Information

Red	Green	Deep Red	Description
HDSP-H1E1	HDSP-H1G1	HDSP-H1A1	Common Anode, Right Hand Decimal
HDSP-H1E3	HDSP-H1G3	HDSP-H1A3	Common Cathode, Right Hand Decimal

Figure 1 Package Dimension

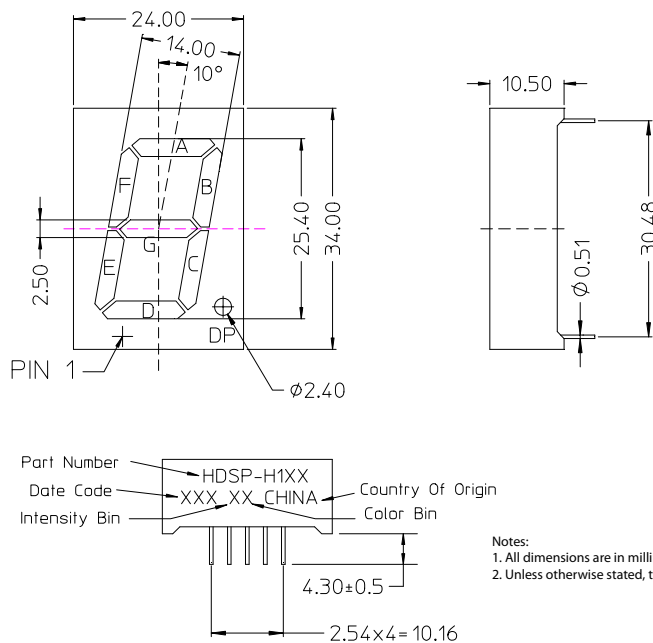

Notes:
 1. All dimensions are in millimeters.
 2. Unless otherwise stated, the tolerance is ±0.25 mm.

Figure 2 Circuit Diagram

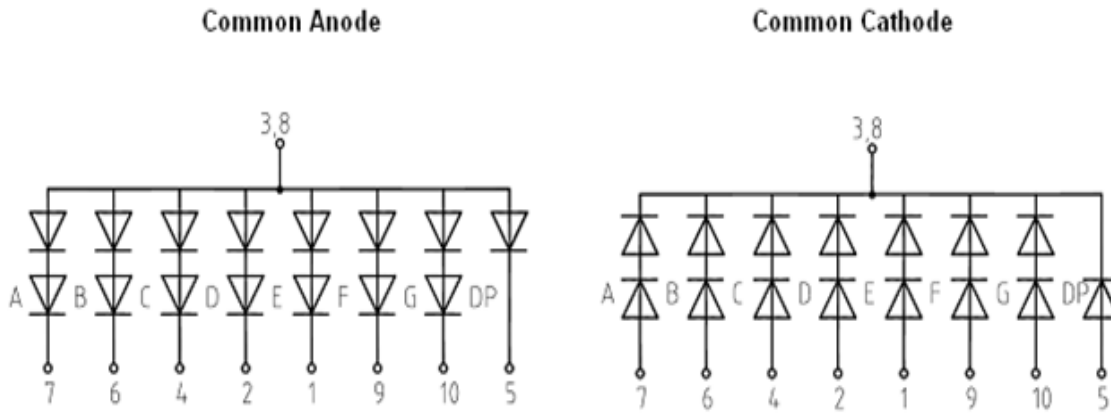

Table 2 Absolute Maximum Ratings at $T_A = 25^\circ\text{C}$

Parameter	Symbol	Red/Green/Deep Red	Units
Power Dissipation per segment or Dot Point (DP)	P_D	104/52	mW
Continuous Forward Current per segment	I_F	20	mA
Peak Forward Current per segment (1/10 Duty Cycle, 0.1m sec pulse width)		100	mA
Derating Linearly from 25°C per segment		0.21	mA/ $^\circ\text{C}$
Reverse Voltage per segment or DP	V_R	Not designed for reverse biasing	
Operating Temperature	T_O	-40 to 85	$^\circ\text{C}$
Storage Temperature	T_S	-40 to 85	$^\circ\text{C}$
Wave solder Condition 1.6mm below body		260 $^\circ\text{C}$ peak for 3 secs max	

Table 3 Red Electrical/Optical Characteristics at $T_A = 25^\circ\text{C}$

Parameter	Symbol	Min	Typ	Max	Units	Test Conditions
Average Luminous Intensity (Digit Average)	I_V	—	70	—	mcd	$I_F = 10\text{ mA}$
Peak Wavelength	λ_p	—	634	—	nm	$I_F = 20\text{ mA}$
Dominant Wavelength	λ_d	—	625	—	nm	$I_F = 20\text{ mA}$
Forward Voltage per segment / DP	V_F	—	4.0/2.0	5.2/2.6	V	$I_F = 20\text{ mA}$
Reverse Current per segment / DP ^a	I_R	—	—	100	μA	$V_R = 10\text{ V} / 5\text{ V (DP)}$
Luminous Intensity Matching Ratio (Segment to Segment)	I_{V-M}	—	2:1	—	—	$I_F = 10\text{ mA}$

a. Indicates production go-no-go test only. Long term reverse biasing is not recommended.

Table 4 Green Electrical/Optical Characteristics at $T_A = 25^\circ\text{C}$

Parameter	Symbol	Min	Typ	Max	Units	Test Conditions
Average Luminous Intensity (Digit Average)	I_V	—	25	—	mcd	$I_F = 10\text{ mA}$
Peak Wavelength	λ_p	—	570	—	nm	$I_F = 20\text{ mA}$
Dominant Wavelength	λ_d	—	571	—	nm	$I_F = 20\text{ mA}$
Forward Voltage per segment / DP	V_F	—	4.0/2.0	5.2/2.6	V	$I_F = 20\text{ mA}$
Reverse Current per segment / DP ^a	I_R	—	—	100	μA	$V_R = 10\text{ V} / 5\text{ V (DP)}$
Luminous Intensity Matching Ratio (Segment to Segment)	I_{V-M}	—	2:1	—	—	$I_F = 10\text{ mA}$

a. Indicates production go-no-go test only. Long term reverse biasing is not recommended.

Table 5 Deep Red Electrical/Optical Characteristics at $T_A = 25^\circ\text{C}$

Parameter	Symbol	Min	Typ	Max	Units	Test Conditions
Average Luminous Intensity (Digit Average)	I_V	—	70	—	mcd	$I_F = 10\text{ mA}$
Peak Wavelength	λ_p	—	644	—	nm	$I_F = 20\text{ mA}$
Dominant Wavelength	λ_d	—	635	—	nm	$I_F = 20\text{ mA}$
Forward Voltage per segment / DP	V_F	—	4.0/2.0	5.2/2.6	V	$I_F = 20\text{ mA}$
Reverse Current per segment / DP ^a	I_R	—	—	100	μA	$10\text{ V} / 5\text{ V (DP)}$
Luminous Intensity Matching Ratio (Segment to Segment)	I_{V-M}	—	2:1	—	—	$I_F = 10\text{ mA}$

a. Indicates production go-no-go test only. Long term reverse biasing is not recommended.

Red

Figure 3 Relative Luminous Intensity Vs Forward Current

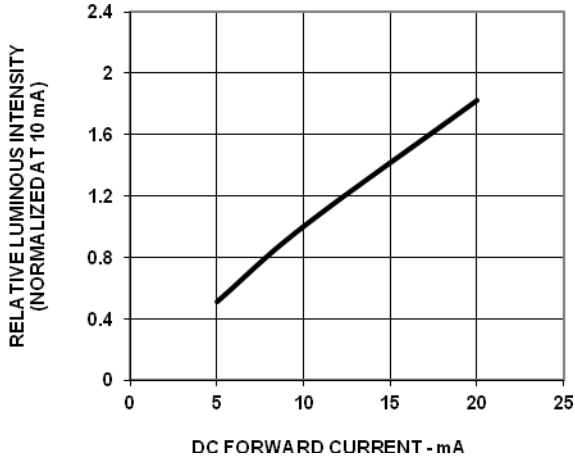

Figure 4 Forward Voltage Vs Current (Segment)

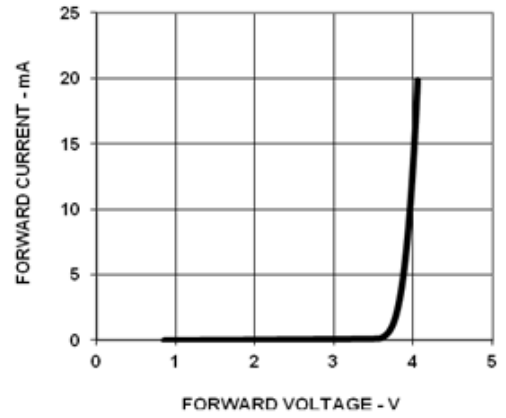

Figure 5 Forward Voltage Vs Current (DP)

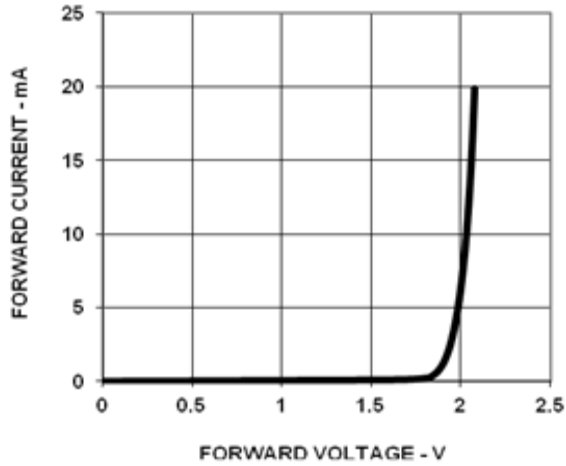
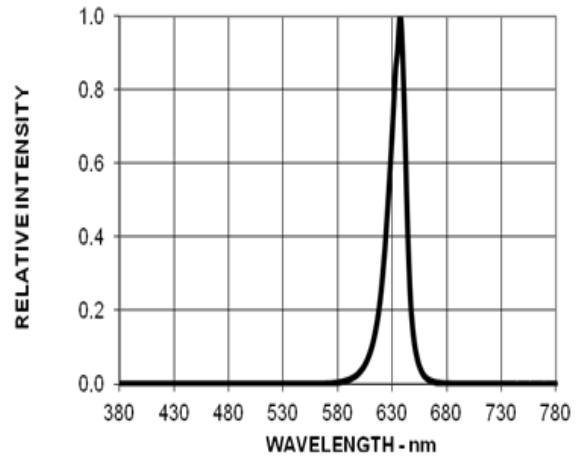

Figure 6 Relative Luminous Intensity Vs Wavelength



Green

Figure 7 Relative Luminous Intensity Vs Forward Current

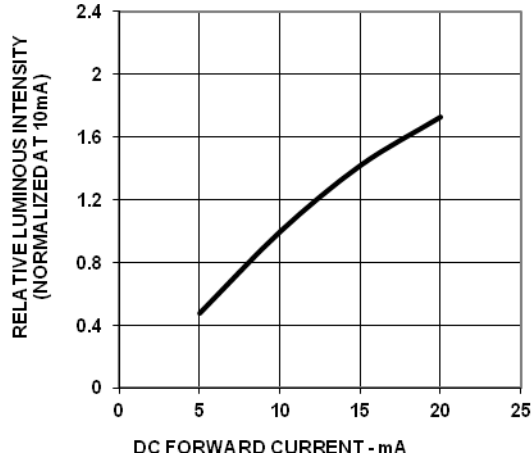

Figure 8 Forward Voltage Vs Current (Segment)

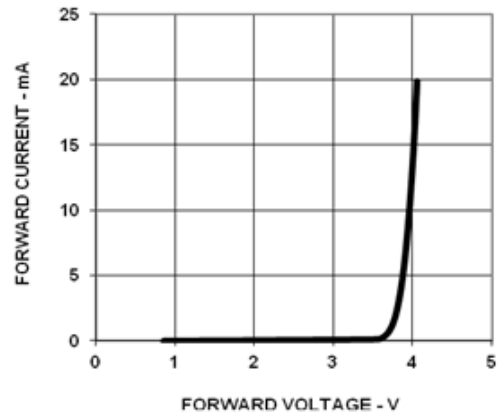

Figure 9 Forward Voltage Vs Current (DP)

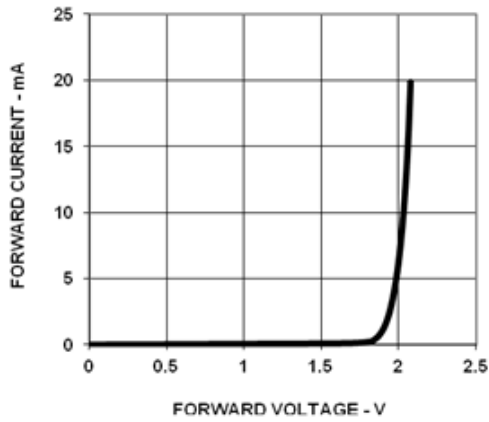
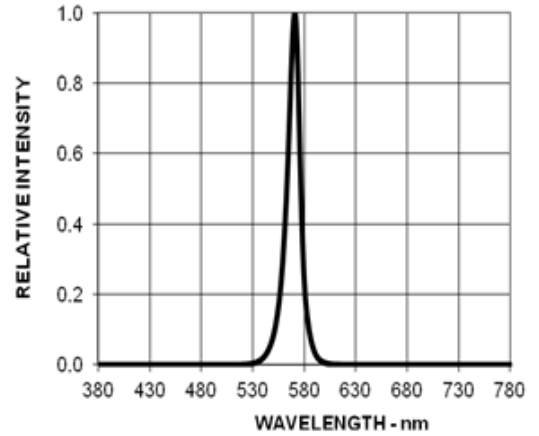

Figure 10 Relative Luminous Intensity Vs Wavelength



Deep Red

Figure 11 Relative Luminous Intensity Vs Forward Current

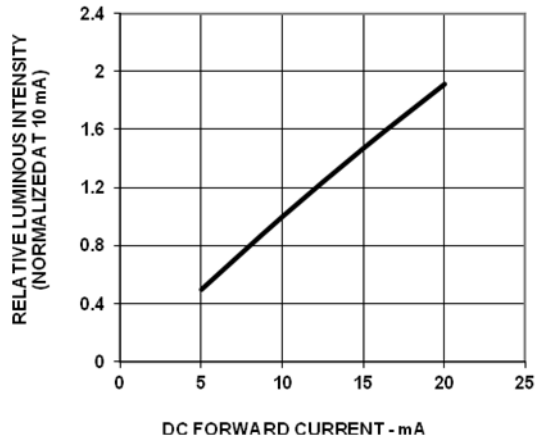

Figure 12 Forward Voltage Vs Current (Segment)

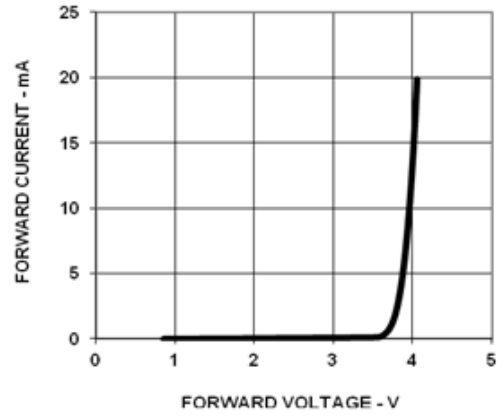

Figure 13 Forward Voltage Vs Current (DP)

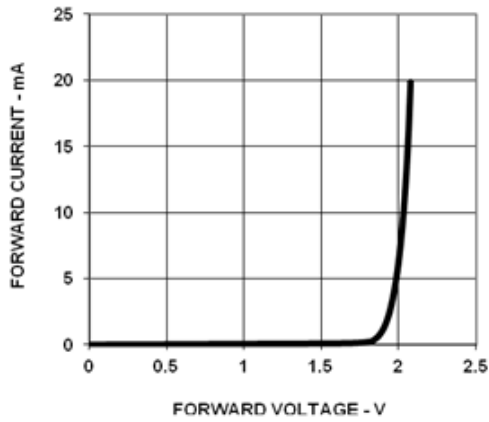
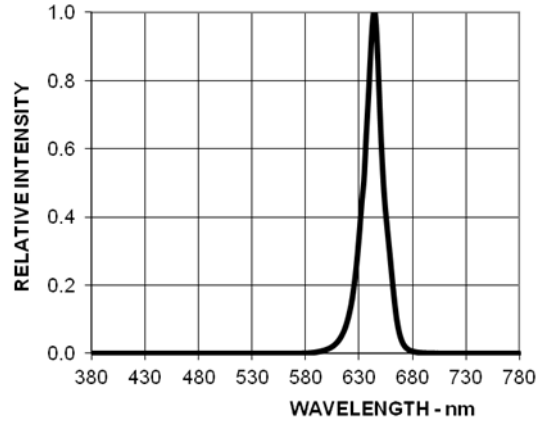
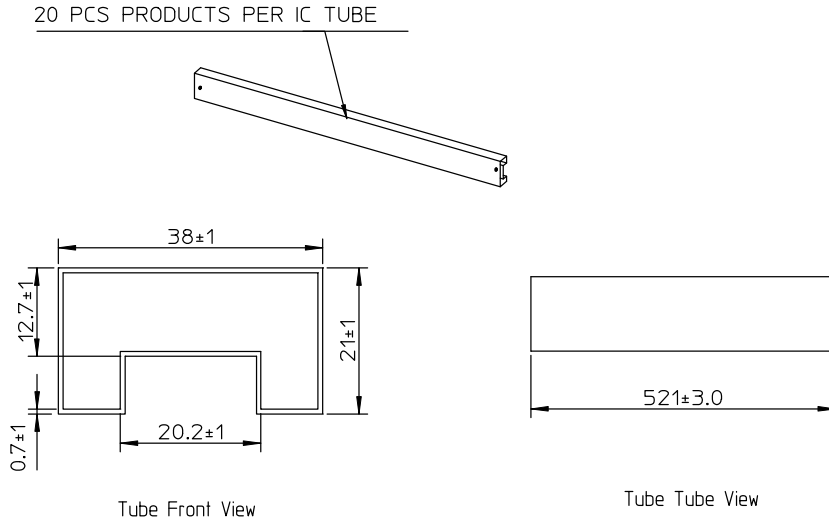

Figure 14 Relative Luminous Intensity Vs Wavelength



Packing Tube Specifications



Reference

For further information on soldering LEDs, please refer to Avago Technologies Application Note 1027.

For product information and a complete list of distributors, please go to our web site:

www.avagotech.com

Avago Technologies and the A logo are trademarks of Avago Technologies in the United States and other countries. All other brand and product names may be trademarks of their respective companies.

Data subject to change. Copyright © 2015 Avago Technologies. All Rights Reserved.

pub-005314 – December 16, 2015

AVAGO
TECHNOLOGIES