



Chipsmall Limited consists of a professional team with an average of over 10 year of expertise in the distribution of electronic components. Based in Hongkong, we have already established firm and mutual-benefit business relationships with customers from,Europe,America and south Asia,supplying obsolete and hard-to-find components to meet their specific needs.

With the principle of “Quality Parts,Customers Priority,Honest Operation,and Considerate Service”,our business mainly focus on the distribution of electronic components. Line cards we deal with include Microchip,ALPS,ROHM,Xilinx,Pulse,ON,Everlight and Freescale. Main products comprise IC,Modules,Potentiometer,IC Socket,Relay,Connector.Our parts cover such applications as commercial,industrial, and automotives areas.

We are looking forward to setting up business relationship with you and hope to provide you with the best service and solution. Let us make a better world for our industry!



Contact us

Tel: +86-755-8981 8866 Fax: +86-755-8427 6832

Email & Skype: info@chipsmall.com Web: www.chipsmall.com

Address: A1208, Overseas Decoration Building, #122 Zhenhua RD., Futian, Shenzhen, China



HDSP-Uxxx Series

HDSP-U1xx/U2xx/U3xx/U4xx/U5xx Series

8 mm (0.31 inch) Ultra Mini Seven Segment Displays



Data Sheet

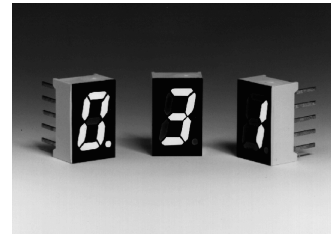

Description

The 8 mm (0.31 inch) LED seven segment displays are Avago's most space-efficient character size. They are designed for viewing distances up to 3 metres (10 feet). The numeric devices feature a right hand decimal point. All devices are available as either common anode or common cathode.

Typical applications include appliances, temperature controllers, and digital panel meters.

Features

- Compact package
- 8 mm (0.31 inch) character height
- Choice of colors:
 - Wide range of colors
- Excellent appearance:
 - Evenly lighted segments
 - Mitered corners on segments
 - Gray/black surface gives optimum contrast
 - $\pm 50^\circ$ viewing angle
- Design flexibility:
 - Common anode or common cathode
 - Right hand decimal point
- Categorized for luminous intensity:
 - Yellow and Green also categorized for color
 - Use of like categories yields a uniform display
- High light output
- High peak current
- Excellent for long digit string multiplexing
- Intensity and color selection option

Devices

AlGaAs Red HDSP-	HER HDSP-	Orange HDSP-	Yellow HDSP-	Green HDSP-	Description	Circuit Diagram
U101	U201	U401	U301	U501	Common Anode, Right Hand Decimal, Gray Surface	A
U103	U203	U403	U303	U503	Common Cathode, Right Hand Decimal, Gray Surface	B
U111	U211	U411	U311	U511	Common Anode, Right Hand Decimal, Black Surface	A
U113	U213	U413	U313	U513	Common Cathode, Right Hand Decimal, Black Surface	B

Part Numbering System

5082 - x xx x - x x x xx
 HDSP - x xx x - x x x xx

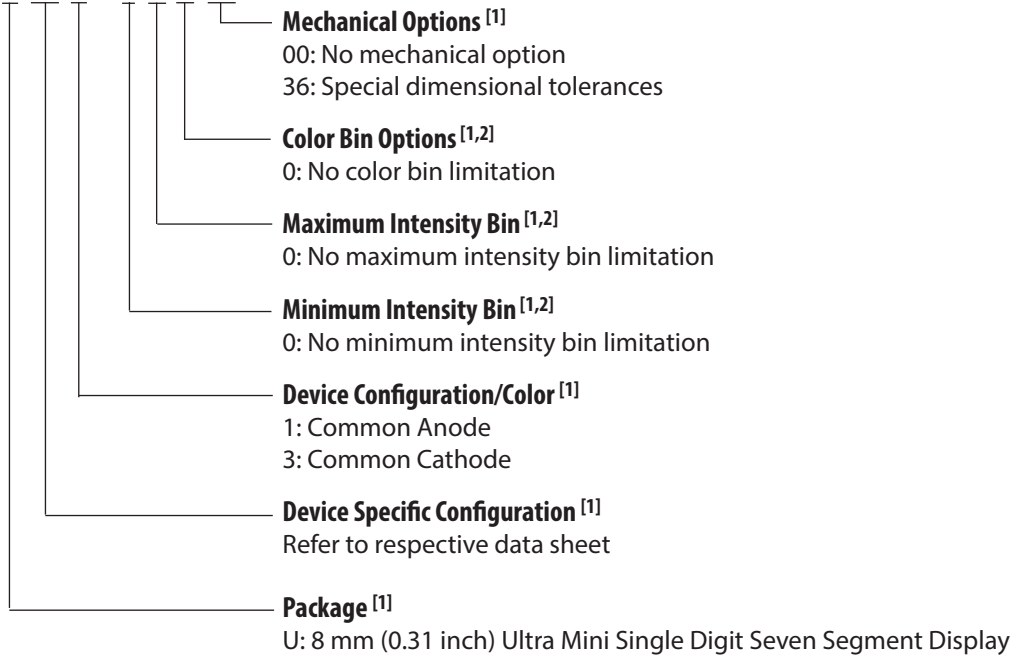

Notes:

1. For codes not listed in the figure above, please refer to the respective data sheet or contact your nearest Avago representative for details.
2. Bin options refer to shippable bins for a part-number. Color and Intensity Bins are typically restricted to 1 bin per tube (exceptions may apply). Please refer to respective data sheet for specific bin limit information.

Package Dimensions

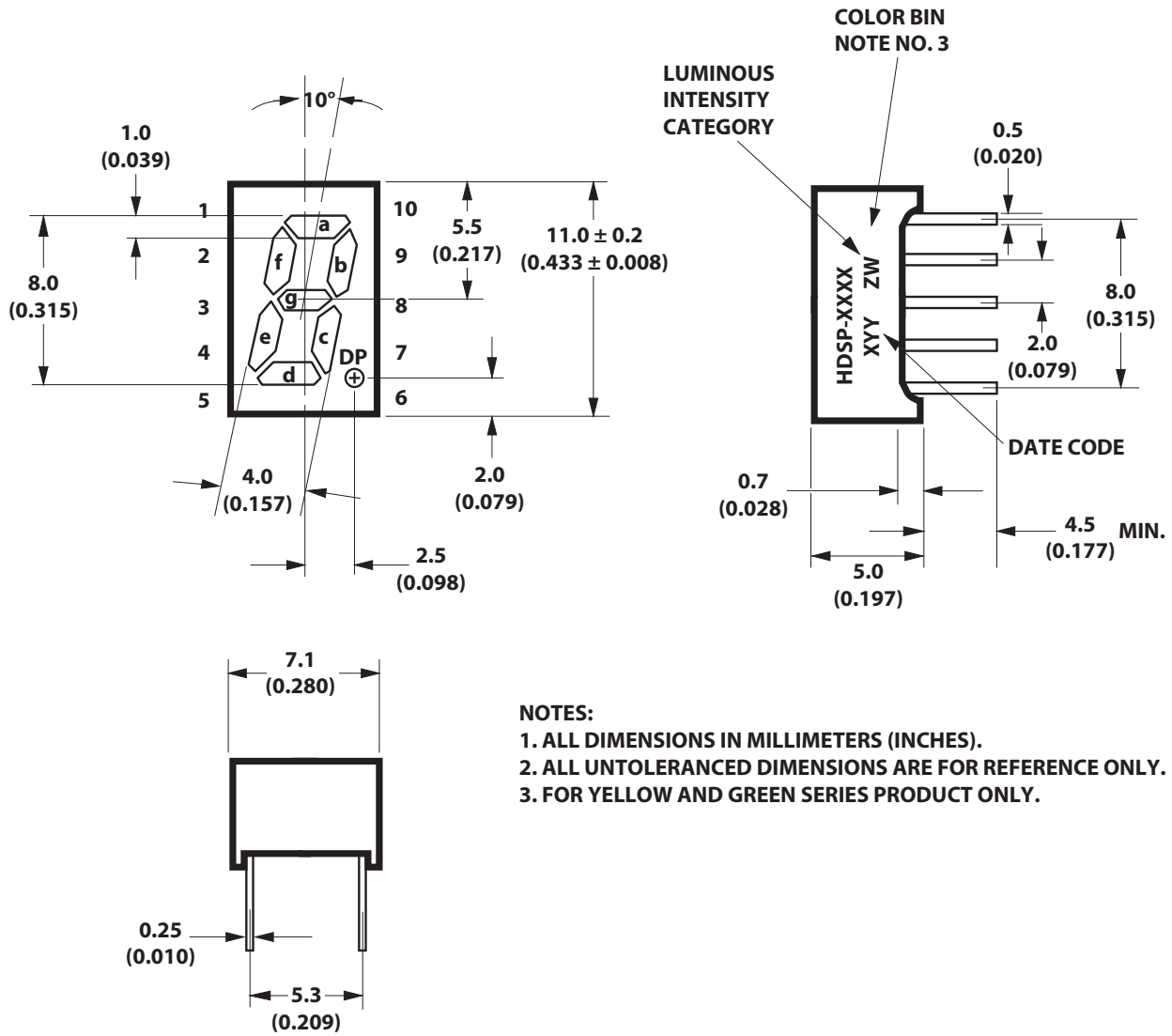

Internal Circuit Diagram

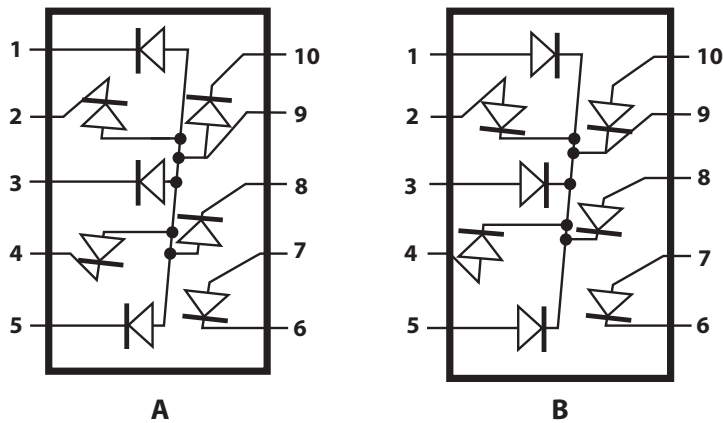

PIN	FUNCTION	
	A	B
1	CATHODE a	ANODE a
2	CATHODE f	ANODE f
3	CATHODE g	ANODE g
4	CATHODE e	ANODE e
5	CATHODE d	ANODE d
6	CATHODE DP	CATHODE DP
7	ANODE DP	ANODE DP
8	CATHODE c	ANODE c
9	ANODE	CATHODE
10	CATHODE b	ANODE b

HDSP-UOXX circuit

Absolute Maximum Ratings

Description	AlGaAs Red HDSP-U1xx Series	HER/Orange HDSP-U2xx/-4xx Series	Yellow HDSP-U3xx Series	Green HDSP-U5xx Series	Units
Average Power per Segment or DP	37	105	80	105	mW
Peak Forward Current per Segment or DP	45 [1]	90 [3]	60 [5]	90 [7]	mA
DC Forward Current per Segment or DP	15 [2]	30 [4]	20 [6]	30 [8]	mA
Operating Temperature Range	-20 to +90		-20 to +90		°C
Storage Temperature Range				-30 to +90	°C
Reverse Voltage* per Segment or DP				3.0	V
Wavesoldering Temperature for 3 Seconds (1.60 mm [0.063 in.] below body)				250	°C

* Reverse Voltage is for LED testing purpose and not recommended to be used as application condition.

Note:

1. See Figure 1 to establish pulsed conditions.
2. No derating over specified temperature range.
3. See Figure 5 to establish pulsed conditions.
4. Derate above 53° C at 0.45 mA/°C (see Figure 8).
5. See Figure 6 to establish pulsed conditions.
6. Derate above 81° C at 0.52 mA/°C (see Figure 8).
7. See Figure 7 to establish pulsed conditions.
8. Derate above 39° C at 0.37 mA/°C (see Figure 8).

Electrical/Optical Characteristics at $T_A = 25^\circ\text{C}$

AlGaAs Red

Device Series - HDSP-U1xx

Parameter	Symbol	Min.	Typ.	Max.	Units	Test Conditions
Luminous Intensity/Segment (Digit Average) [1,2]	I_V	315	600		μcd	$I_F = 1\text{ mA}$
			3600			$I_F = 5\text{ mA}$
Forward Voltage/Segment or DP	V_F		1.6		V	$I_F = 1\text{ mA}$
			1.7			$I_F = 5\text{ mA}$
			1.8	2.2		$I_F = 20\text{ mA}$
Peak Wavelength	λ_{PEAK}		645		nm	
Dominant Wavelength [3]	λ_d		637		nm	
Reverse Voltage/Segment or DP [4]	V_R	3.0	15		V	$I_R = 100\ \mu\text{A}$
Temperature Coefficient of V_F /Segment or DP	$\Delta V_F/^\circ\text{C}$		-2		mV/°C	
Thermal Resistance LED Junction-to-Pin	$R_{\theta J-PIN}$		255		°C/W/Seg	

High Efficiency Red

Device Series - HDSP-U2xx

Parameter	Symbol	Min.	Typ.	Max.	Units	Test Conditions
Luminous Intensity/Segment (Digit Average) [1,2]	I_V	360	980		μcd	$I_F = 5\text{ mA}$
			5390			$I_F = 20\text{ mA}$
Forward Voltage/Segment or DP	V_F		2.0	2.5	V	$I_F = 20\text{ mA}$
Peak Wavelength	λ_{PEAK}		635		nm	
Dominant Wavelength [3]	λ_d		626		nm	
Reverse Voltage/Segment or DP [4]	V_R	3.0	30		V	$I_R = 100\ \mu\text{A}$
Temperature Coefficient of V_F /Segment or DP	$\Delta V_F/^\circ\text{C}$		-2		mV/°C	
Thermal Resistance LED Junction-to-Pin	$R_{\theta J-PIN}$		200		°C/W/Seg	

Orange

Device Series - HDSP-U4xx

Parameter	Symbol	Min.	Typ.	Max.	Units	Test Conditions
Luminous Intensity/Segment (Digit Average) ^[1,2]	I_V	360	980		μcd	$I_F = 5 \text{ mA}$
			5390			$I_F = 20 \text{ mA}$
Forward Voltage/Segment or DP	V_F		2.0	2.5	V	$I_F = 20 \text{ mA}$
Peak Wavelength	λ_{PEAK}		600		nm	
Dominant Wavelength ^[3]	λ_d		603		nm	
Reverse Voltage/Segment or DP ^[4]	V_R	3.0	30		V	$I_R = 100 \mu\text{A}$
Temperature Coefficient of V_F /Segment or DP	$\Delta V_F/^\circ\text{C}$		-2		mV/°C	
Thermal Resistance LED Junction-to-Pin	$R\theta_{\text{J-PIN}}$		200		°C/W/Seg	

Yellow

Device Series - HDSP-U3xx

Parameter	Symbol	Min.	Typ.	Max.	Units	Test Conditions
Luminous Intensity/Segment (Digit Average) ^[1,2]	I_V	225	480		μcd	$I_F = 5 \text{ mA}$
			2740			$I_F = 20 \text{ mA}$
Forward Voltage/Segment or DP	V_F		2.2	2.5	V	$I_F = 20 \text{ mA}$
Peak Wavelength	λ_{PEAK}		583		nm	
Dominant Wavelength ^[3,5]	λ_d	581.5	586	592.5	nm	
Reverse Voltage/Segment or DP ^[4]	V_R	3.0	50.0		V	$I_R = 100 \mu\text{A}$
Temperature Coefficient of V_F /Segment or DP	$\Delta V_F/^\circ\text{C}$		-2		mV/°C	
Thermal Resistance LED Junction-to-Pin	$R\theta_{\text{J-PIN}}$		200		°C/W/Seg	

High Performance Green

Device Series - HDSP-U5xx

Parameter	Symbol	Min.	Typ.	Max.	Units	Test Conditions
Luminous Intensity/Segment (Digit Average) ^[1,2]	I_V	860	3000		μcd	$I_F = 10 \text{ mA}$
			6800			$I_F = 20 \text{ mA}$
Forward Voltage/Segment or DP	V_F		2.1	2.5	V	$I_F = 10 \text{ mA}$
Peak Wavelength	λ_{PEAK}		566		nm	
Dominant Wavelength ^[3,5]	λ_d		571		nm	
Reverse Voltage/Segment or DP ^[4]	V_R	3.0	50.0		V	$I_R = 100 \mu\text{A}$
Temperature Coefficient of V_F /Segment or DP	$\Delta V_F/^\circ\text{C}$		-2		mV/°C	
Thermal Resistance LED Junction-to-Pin	$R\theta_{\text{J-PIN}}$		200		°C/W/Seg	

Notes:

1. Case temperature of device immediately prior to the intensity measurement is 25° C.
2. The digits are categorized for luminous intensity. The intensity category is designated by a letter on the side of the package.
3. The dominant wavelength, λ_d , is derived from the CIE chromaticity diagram and is that single wavelength which defines the color of the device.
4. Typical specification for reference only. Do not exceed absolute maximum ratings.
5. The Yellow (HDSP-U3XX) series and Green (HDSP-U5XX) series displays are categorized for dominant wavelength. The category is designated by a number adjacent to the luminous intensity category letter.

AlGaAs Red

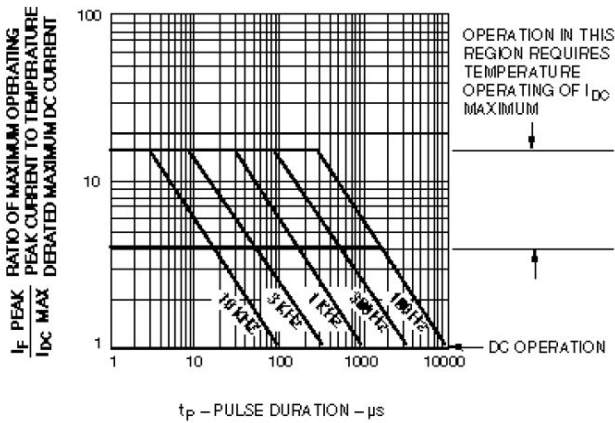

Figure 1. Maximum Tolerable Peak Current vs. Pulse Duration – AlGaAs Red.

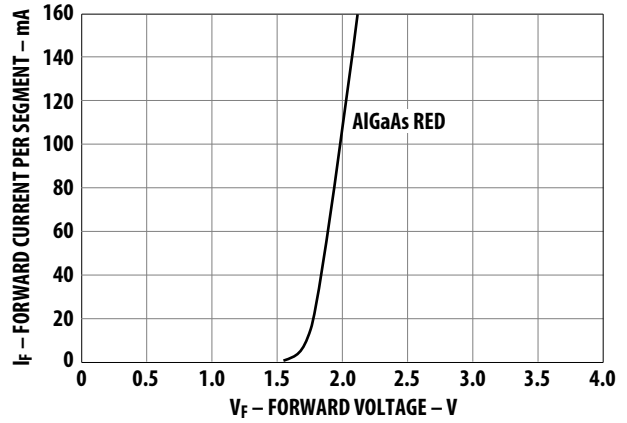

Figure 2. Forward Current vs. Forward Voltage.

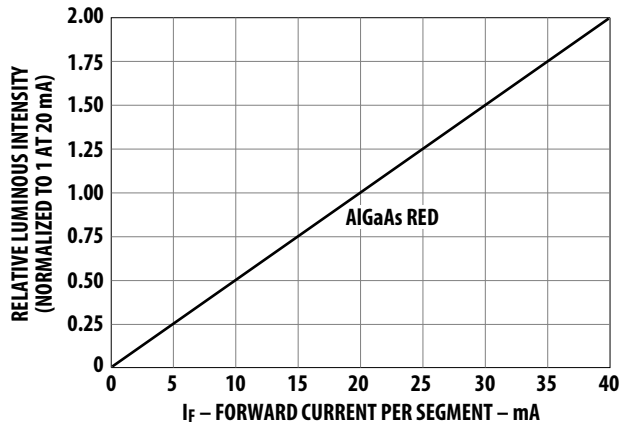

Figure 3. Relative Luminous Intensity vs. DC Forward Current.

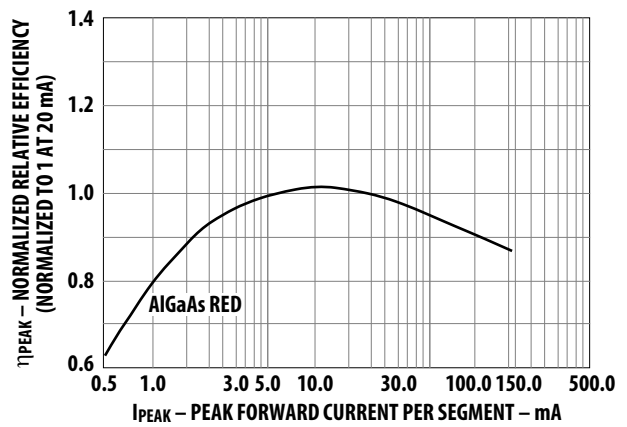

Figure 4. Relative Efficiency (Luminous Intensity per Unit Current) vs. Peak Current.

HER, Orange, Yellow, Green

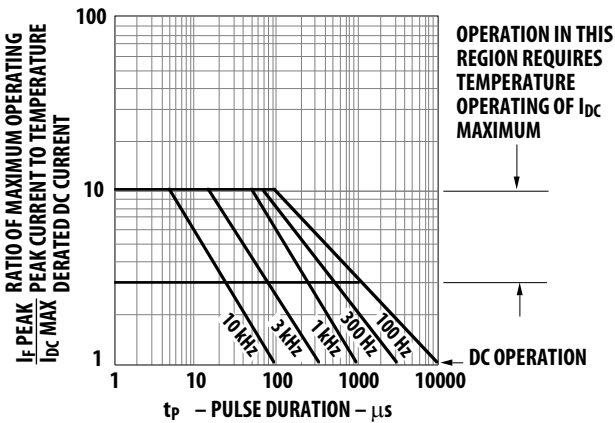

Figure 5. Maximum Tolerable Peak Current vs. Pulse Duration – HER, Orange.

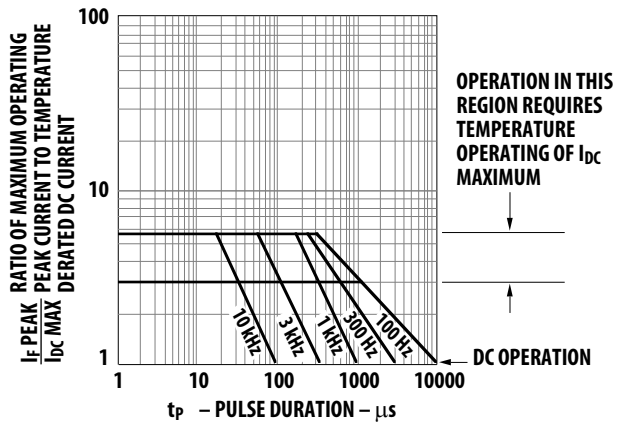

Figure 6. Maximum Tolerable Peak Current vs. Pulse Duration – Yellow.

HER, Orange, Yellow, Green

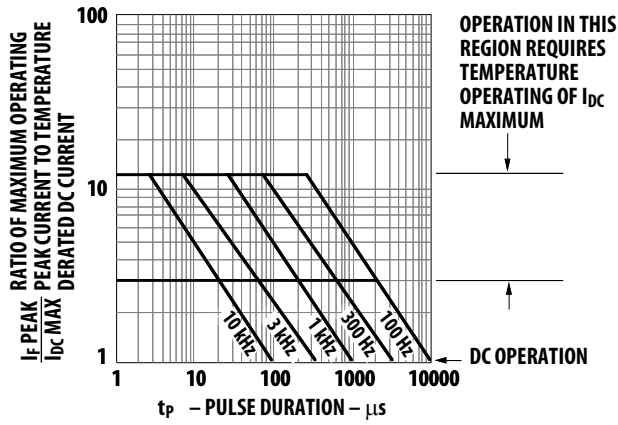

Figure 7. Maximum Tolerable Peak Current vs. Pulse Duration - Green.

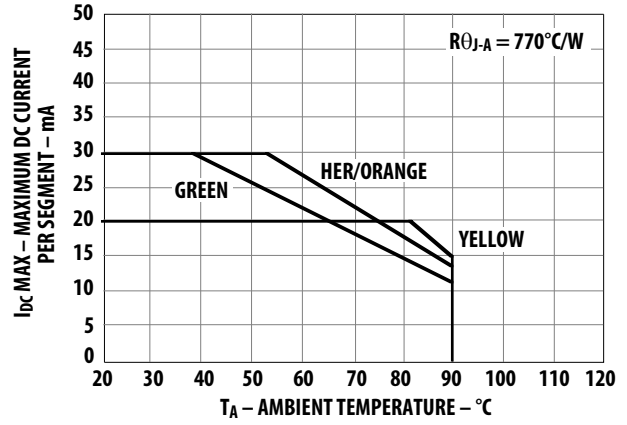

Figure 8. Maximum Allowable DC Current vs. Ambient Temperature.

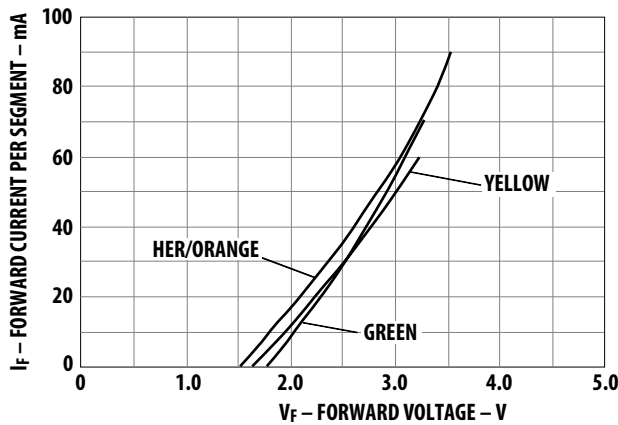

Figure 9. Forward Current vs. Forward Voltage Characteristics.

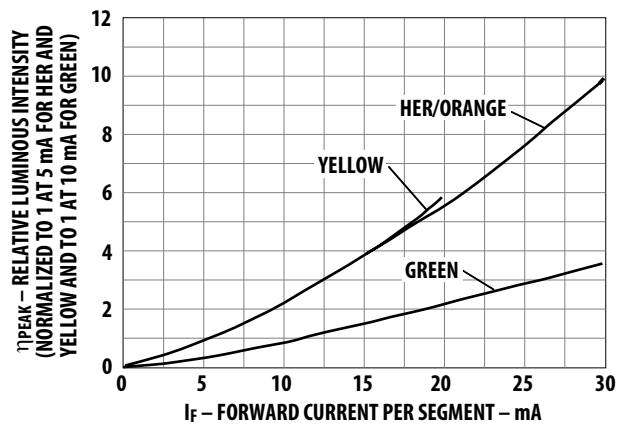

Figure 10. Relative Luminous Intensity vs. DC Forward Current.

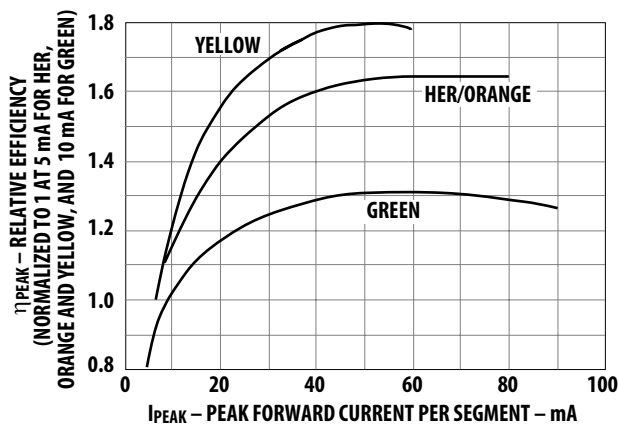

Figure 11. Relative Efficiency (Luminous Intensity per Unit Current) vs. Peak Current.

Intensity Bin Limits (mcd) AlGaAs Red

HDSP-U1xx		
IV Bin Category	Min.	Max.
E	0.315	0.520
F	0.428	0.759
G	0.621	1.16
H	0.945	1.71
I	1.40	2.56
J	2.10	3.84
K	3.14	5.75
L	4.70	8.55

HER

HDSP-U2xx		
IV Bin Category	Min.	Max.
B	0.342	0.630
C	0.516	0.946
D	0.774	1.418
E	1.160	2.127
F	1.740	3.190
G	2.610	4.785
H	3.915	7.177

Orange

HDSP-U4xx		
IV Bin Category	Min.	Max.
C	0.443	0.677
D	0.554	0.846
E	0.692	1.057
F	0.856	1.322
G	1.082	1.652
H	1.352	2.066
I	1.692	2.581
J	2.114	3.227
K	2.641	4.034
L	3.300	5.042
M	4.127	6.303
N	5.157	7.878

Yellow

HDSP-U3xx		
IV Bin Category	Min.	Max.
B	0.229	0.387
C	0.317	0.582
D	0.476	0.872
E	0.714	1.311
F	1.073	1.967
G	1.609	2.950
H	2.413	4.425

Green

HDSP-U5xx		
IV Bin Category	Min.	Max.
H	0.86	1.58
I	1.29	2.37
J	1.94	3.55
K	2.90	5.33
L	4.37	8.01

Color Categories

Color	Bin	Dominant Wavelength (nm)	
		Min.	Max.
Yellow	1	581.50	585.00
	3	584.00	587.50
	2	586.50	590.00
	4	589.00	592.50
Green	2	573.00	577.00
	3	570.00	574.00
	4	567.00	571.00
	5	564.00	568.00

Note:

All categories are established for classification of products. Products may not be available in all categories. Please contact your local Avago representatives for further clarification/information.

Electrical/Optical

For more information on electrical/optical characteristics, please see Application Note 1005.

Contrast Enhancement

For information on contrast enhancement, please see Application Note 1015.

Soldering/Cleaning

Cleaning agents from the ketone family (acetone, methyl ethyl ketone, etc.) and from the chlorinated hydrocarbon family (methylene chloride, trichloroethylene, carbon tetrachloride, etc.) are not recommended for cleaning LED parts. All of these various solvents attack or dissolve the encapsulating materials used to form the package of plastic LED parts.

For more information on soldering LEDs, please refer to Application Note 1027.

For product information and a complete list of distributors, please go to our web site: www.avagotech.com

Avago, Avago Technologies, and the A logo are trademarks of Avago Technologies in the United States and other countries. Data subject to change. Copyright © 2005–2015 Avago Technologies. All rights reserved. Obsoletes 5988-2220EN AV02-3584EN - October 9, 2015

