



Chipsmall Limited consists of a professional team with an average of over 10 year of expertise in the distribution of electronic components. Based in Hongkong, we have already established firm and mutual-benefit business relationships with customers from,Europe,America and south Asia,supplying obsolete and hard-to-find components to meet their specific needs.

With the principle of “Quality Parts,Customers Priority,Honest Operation,and Considerate Service”,our business mainly focus on the distribution of electronic components. Line cards we deal with include Microchip,ALPS,ROHM,Xilinx,Pulse,ON,Everlight and Freescale. Main products comprise IC,Modules,Potentiometer,IC Socket,Relay,Connector.Our parts cover such applications as commercial,industrial, and automotives areas.

We are looking forward to setting up business relationship with you and hope to provide you with the best service and solution. Let us make a better world for our industry!



## Contact us

Tel: +86-755-8981 8866 Fax: +86-755-8427 6832

Email & Skype: info@chipsmall.com Web: www.chipsmall.com

Address: A1208, Overseas Decoration Building, #122 Zhenhua RD., Futian, Shenzhen, China



### DESCRIPTION

HF81 is an innovative two-terminal IC that automatically discharges an X capacitor while eliminating power losses and allowing power supplies to comply with safety standards.

The HF81 acts as a smart high-voltage switch when placed in series with discharge resistors (alternatively bleed resistors). In the presence of an AC voltage, the HF81 blocks current flow in the safety discharge resistors to reduce the power loss in these components to zero at 230 VAC. When disconnected from the AC voltage, the HF81 automatically and safely discharges the X capacitor by closing the circuit through the bleed resistors and directing the energy away from the exposed AC plug.

Table 1: Component Selection Table

PN	X Capacitance	Total Series Resistance	Power Saving <sup>(1)</sup>
HF81	≤500nF	1.5MΩ	
	750nF	1MΩ	66mW
	1μF	780kΩ	86mW
	1.5μF	480kΩ	142mW
	2μF	360kΩ	191mW
	2.5μF	300kΩ	230mW
	3.5μF	200kΩ	347mW
	5μF	150kΩ	464mW

**Notes:**

1) The values are calculated at Vin=265Vac

### FEATURES

- Disconnect series discharge resistors from L-N when AC voltage is applied
- Connect series discharge resistors with L-N to discharge the X capacitor when AC voltage is unplugged
- Supplied by AC voltage directly and doesn't need external bias
- Meets safety standards for use before or after input fuse
- No external ground pin leads to high common mode surge immunity
- 1000V internal JFET inside leads to high differential surge immunity
- >4mm creepage on package and PCB
- Compliant to IEC 60950-1

### APPLICATIONS

- AC/DC converters with X capacitors larger than 0.1μF
- All converters requiring ultra-low no-load consumption and low standby power
- Appliances requiring EuP Lot 6 compliance
- Appliances requiring Energy Star V2.0
- White Goods (For example, Dishwasher, Washing Machine, Air-Conditioner and etc.)
- Server Power, Telecom Power, ATX Power

All MPS parts are lead-free and adhere to the RoHS directive. For MPS green status, please visit MPS website under Quality Assurance. "MPS" and "The Future of Analog IC Technology" are Registered Trademarks of Monolithic Power Systems, Inc.

### TYPICAL APPLICATION

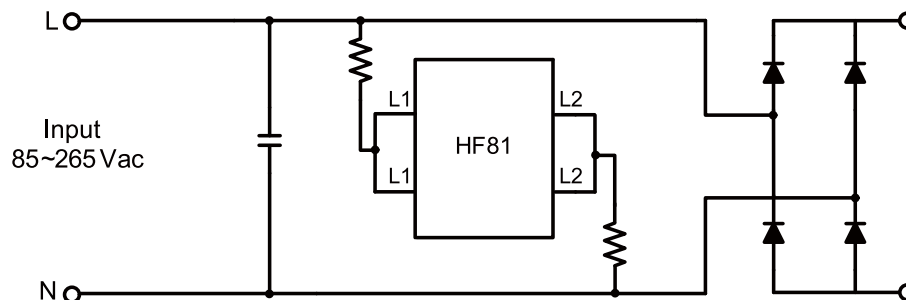

**ORDERING INFORMATION**

Part Number*	Package	Top Marking
HF81GS	SOIC8	HF81

\* For Tape & Reel, add suffix -Z (e.g. HF81GS-Z);

**PACKAGE REFERENCE**

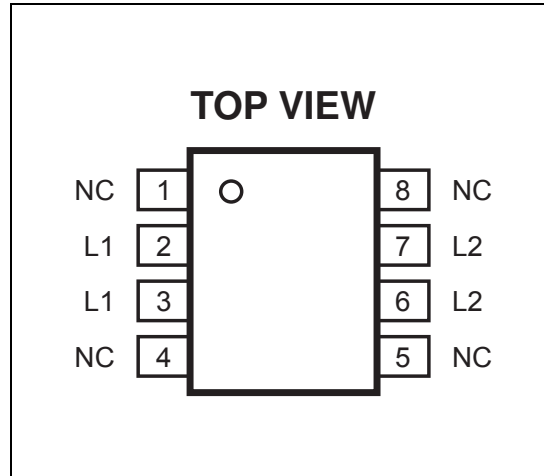

**ABSOLUTE MAXIMUM RATINGS** <sup>(2)</sup>

L1-L2 Pin Voltage .....	1000V
Storage Temperature.....	-65°C to 150°C
Lead Temperature .....	260°C
Continuous Power Dissipation (T <sub>A</sub> = +25°C) <sup>(3)</sup>	1.4W
.....	1.4W
Single Avalanche Energy.....	70μJ <sup>(4)</sup>
Avalanche Current .....	80mA <sup>(4)</sup>
Junction Temperature.....	150°C

**Recommended Operating Conditions** <sup>(5)</sup>

Operating Junction Temp. (T<sub>J</sub>). -40°C to +125°C

Thermal Resistance <sup>(6)</sup>	$\theta_{JA}$	$\theta_{JC}$
SOIC8.....	90	45... °C/W

**Notes:**

- 2) Exceeding these ratings may damage the device.
- 3) The maximum allowable power dissipation is a function of the maximum junction temperature T<sub>J</sub> (MAX), the junction-to-ambient thermal resistance  $\theta_{JA}$ , and the ambient temperature T<sub>A</sub>. The maximum allowable continuous power dissipation at any ambient temperature is calculated by P<sub>D</sub> (MAX) = (T<sub>J</sub> (MAX)-T<sub>A</sub>)/ $\theta_{JA}$ . Exceeding the maximum allowable power dissipation will cause excessive die temperature, and the regulator will go into thermal shutdown. Internal thermal shutdown circuitry protects the device from permanent damage.
- 4) L=5mH, V<sub>gs</sub>=10V, V<sub>DD</sub>=1.4V
- 5) The device is not guaranteed to function outside of its operating conditions.
- 6) Measured on JESD51-7, 4-layer PCB.

## ELECTRICAL CHARACTERISTICS

T<sub>A</sub> = 25°C, unless otherwise noted.

Parameter	Symbol	Condition	Min	Typ	Max	Units
AC Removal Detection Time	t <sub>DETECT</sub>	Line Cycle Frequency 47 to 63Hz		25		ms
Saturation Current <sup>(7)</sup>	I <sub>SC</sub>	L1-L2 voltage from 110V to 410V	3.0			mA
Supply Current	I <sub>SUPPLY</sub>	L1-L2 voltage 1000V			15	μA
UVLO	V_OFF_L1/L2			3.7		V

### Notes:

- 7) Saturation current specifications guarantee natural discharge characteristic at all input voltage with the external resistor and capacitor specified in Table 1.

TYPICAL CHARACTERISTICS

**Leakage Current\_1000V vs. Temperature Chart**

1000V on L1-L2

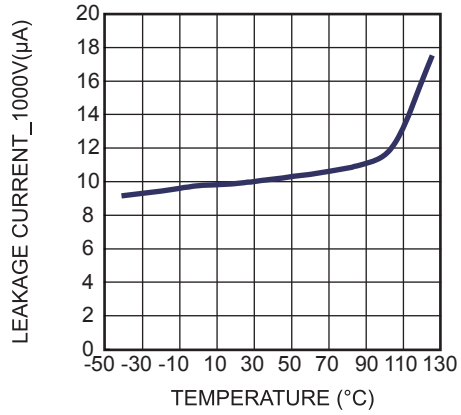

**Detection Time vs. Temperature Chart**

L2 connects GND, voltage on L1 is from -20V to 90V

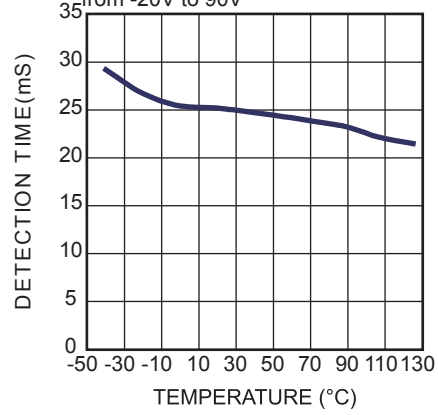

**PIN FUNCTIONS**

Package Pin #	Name	Description
1	NC	Not Connected
2	L1	AC Line 1
3	L1	AC Line 1
4	NC	Not Connected
5	NC	Not Connected
6	L2	AC Line 2
7	L2	AC Line 2
8	NC	Not Connected

## OPERATION

A smart bleeder normally works as an off device: It consumes very little current, it always monitors the AC line for zero crossings; whenever it detects a zero crossing it discharges the timer capacitor and resets the latch circuit.

Whenever a prolonged period occurs without a zero crossing (meaning the power supply unit [PSU] was unplugged from the utility line), the timer block times out and triggers the latch circuit. The latch circuit turns on the discharging transistors, as shown by the timing diagram in Figure 1. The internal transistor enables the bleed resistors, and stops when either the voltage across the HF81 drops below 10V or the PSU is plugged back into the utility line. This operation allows for more X capacitor choices and reduces the inductor cost.

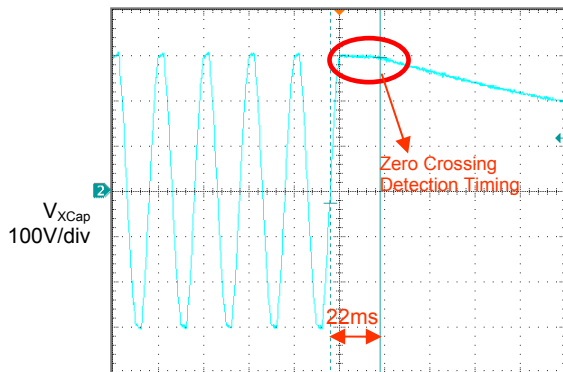

Figure 1: Zero-Crossing Detection Timing

## COMPONENT SELECTION

According to international safety requirements, the X capacitor voltage must drop to 37% within 1s. Based on a 5% tolerance for the discharge resistor and a 20% tolerance for the X capacitor, select an RC time constant of 0.75s. Table 1 provides sample values for the X capacitor and the discharge resistance.

Carefully select a metal oxide varistor (MOV) and fuse to meet safety requirements: The MOV suppresses voltage transients. During normal operation, a MOV with high impedance permits only a small current. When a voltage surge occurs, the MOV resistance reduces to a few  $\Omega$ s, which allows the large surge current to flow through while protecting other devices in parallel to it.

There are several parameters for selecting a MOV, including maximum-allowable voltage, maximum clamping voltage, and the MOV max endured energy. The maximum-allowable voltage must exceed the maximum working voltage by 10%, 20% or the circuit needs an even higher derating, which is determined by the power source stability. After selecting a MOV, verify it using  $V_{1mA}$ , which is the voltage across the MOV the current is 1mA. Simplified, this is:

$$V_{1mA} = 1.5V_{peak} = 2.2V_{AC} \quad (1)$$

Where  $V_{peak}$  is the peak working voltage and  $V_{AC}$  is the rms working voltage.

Also, please make sure the breakdown voltage of other components on the AC side fall below the maximum allowable voltage.

Base MOV size selection on MOV withstanding transient energy. Calculate the energy using formula 2.

$$W = K \times V_{Clamp} \times I_{Peak} \times t \quad (2)$$

Where K is a constant 1.0 for rectangular waveform and 1.4 for 8/20 $\mu$ s and 10/1000 $\mu$ s waveform,  $V_{Clamp}$  is the maximum clamping voltage, and  $I_{Peak}$  is the peak applied current. Make sure that the calculated energy is lower than the rated energy on the MOV datasheet. Select the fuse based on MOV specification.

Generally, select the fuse based on MOV diameter as per Table 2.

Table 2: Fuse Selection Table

MOV Dimension (mm)	Ø5	Ø7	Ø10	Ø14	Ø20
Fuse (A)	1-2	2-3	3-5	3-10	5-15

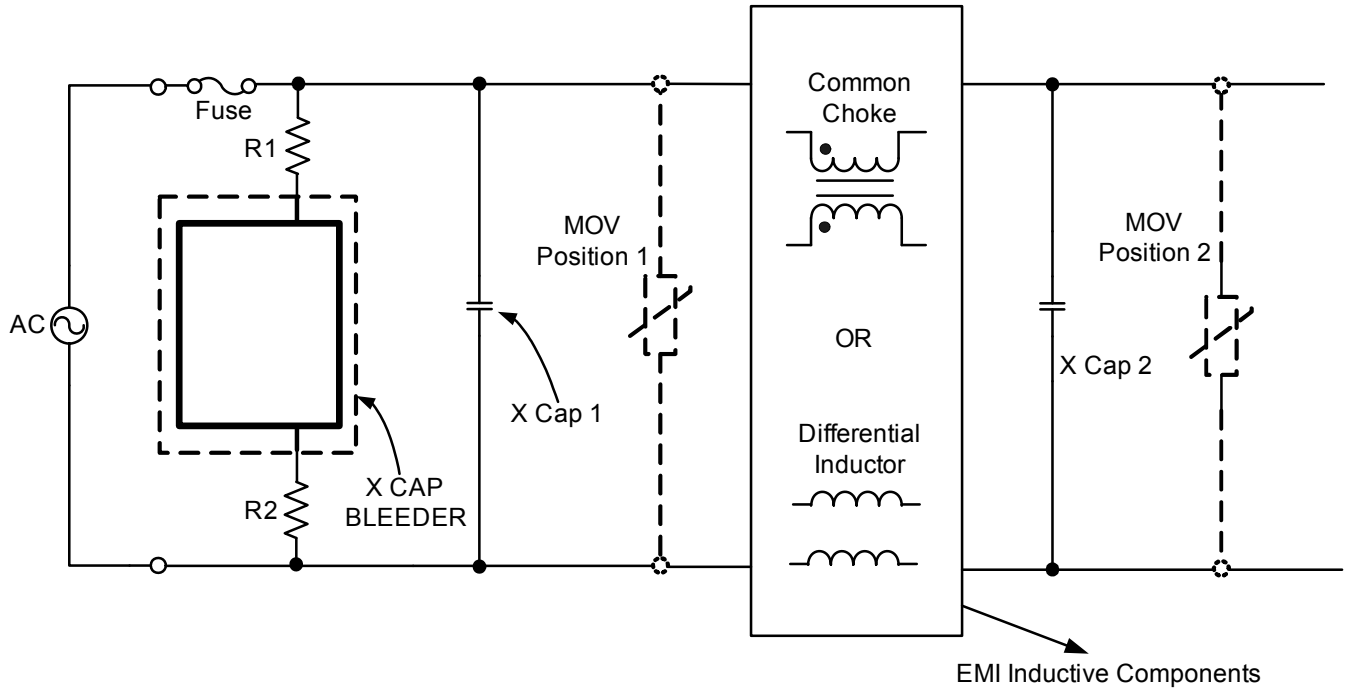

Figure 2: HF81 Position Selection



### HF81 Position Selection

Figure 2 shows a typical front-end configuration of offline products. The configuration influences the position selection for the HF81.

Large currents flow through the MOV whenever a voltage surge occurs, which can cause significant voltage drops across inductive EMI components and traces. Place the HF81 as close as possible to the MOV.

1. For MOV in position 1, place the HF81 directly underneath the X cap.
2. For MOV in position 2, place the HF81 on the same side and physically close to MOV. If the HF81 cannot be placed at the same side as the MOV, make sure the surge level no higher than 1.5kV.
3. For surge levels higher than 1.5kV, place the HF81 and MOV on the same side as the inductive EMI components.

X capacitor can be placed before the input fuse. In this case, if the value of the X capacitor exceeds  $0.1\mu\text{F}$ ; to meet safety requirements, place the HF81 in front of the input fuse. Also, place the MOV before the input fuse if surge voltage is  $>1.5\text{kV}$ .

### PCB Layout and Discharge Resistor Selection

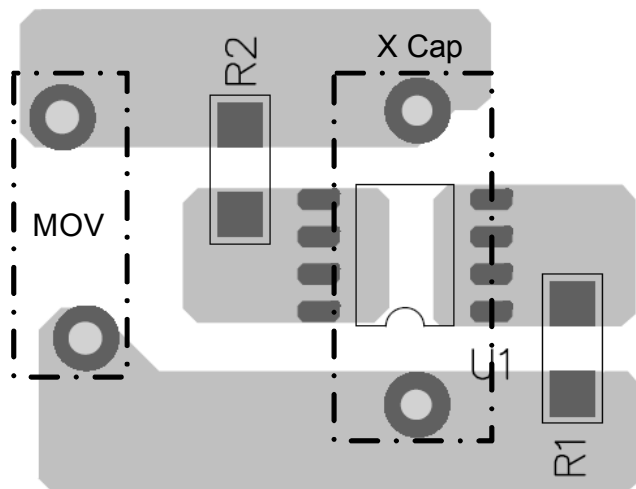

Figure 3: Typical PCB Layout

Figure 3 shows the typical PCB layout of the HF81. The discharge resistors are divided into two separate surface mount resistors. Resistors R1 and R2 need to be rated for 50% power dissipation and voltage rating in order to dissipate loss and withstand the input voltage under a short between the L1 and L2 terminals of the HF81.

If the application needs lower power rating or voltage rating discharge resistor, the discharge resistor can be divided more discrete resistors though the total external resistance must be equal to the values specified in Table 1.

### Safety Consideration

To satisfy safety requirements, the HF81 has double pins for each terminal for design redundancy. During a single point failure test, if one pin is physically disconnected to the part or PCB, the HF81 continues to function normally. If one pin of part shorts to another at an opposite terminal, the HF81 shorts and is equivalent to a system without the HF81, which is also safe.

Table 3 summarizes the results of single-point failure testing. Under open or short conditions, the HF81 has a null effect on power systems compared to systems without the HF81.

Table 3: Single Point of Failure Test

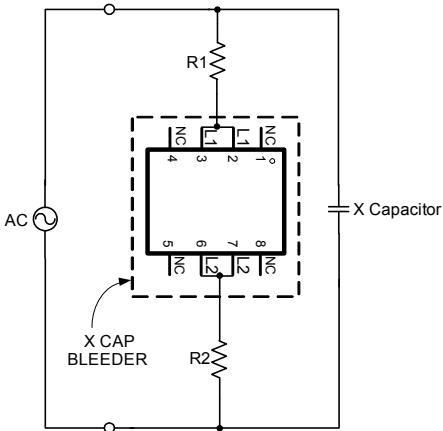
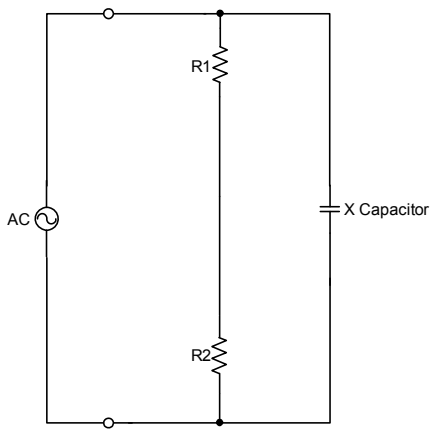
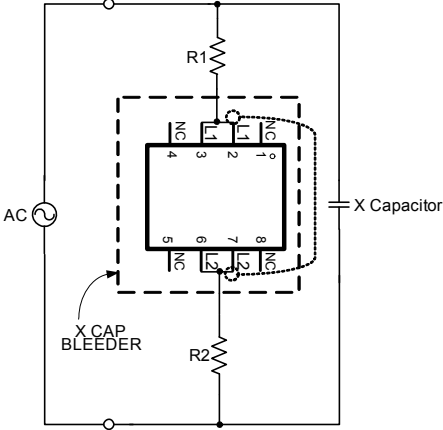
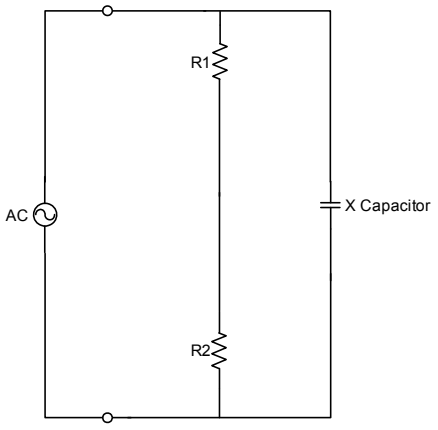
Test	Test with HF81	Test without HF81	Comments
<p><b>Open One Pin</b> Disconnect any pin of HF81 to see it can affect the system</p>			<p>Open one pin of HF81 has no influence of discharge function as two pins at each side for redundancy design.</p>
<p><b>Short Two pins</b> Short any two pins of HF81 to see if it can affect the system</p>			<p>Short two pins at different side leads to the circuit equivalent to a system without HF81.</p>

PACKAGE INFORMATION

SOIC8

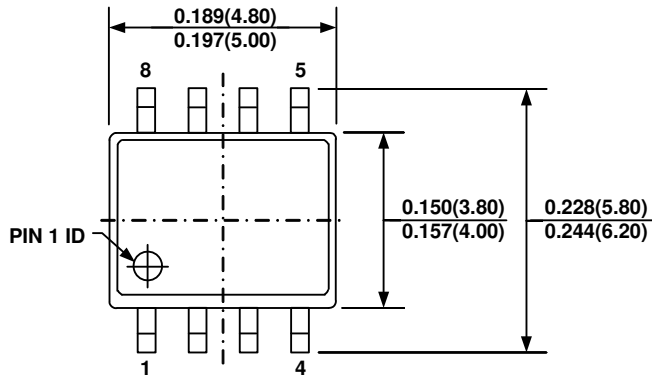

TOP VIEW

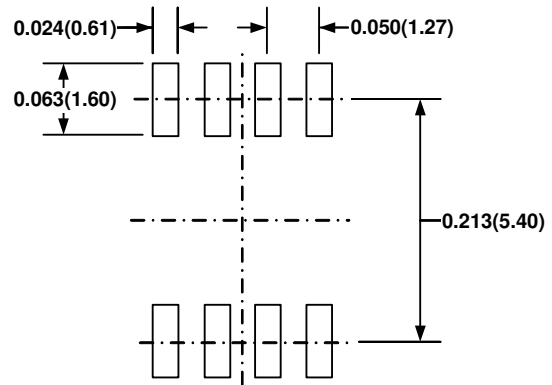

RECOMMENDED LAND PATTERN

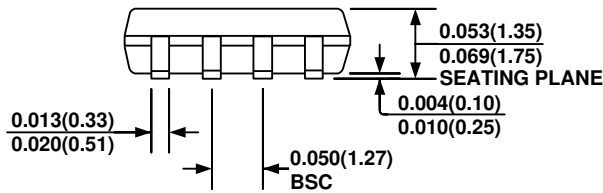

FRONT VIEW

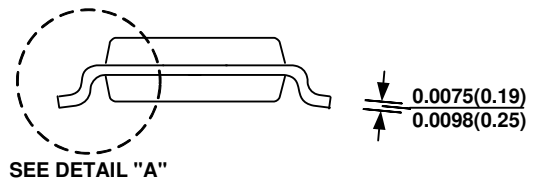

SIDE VIEW

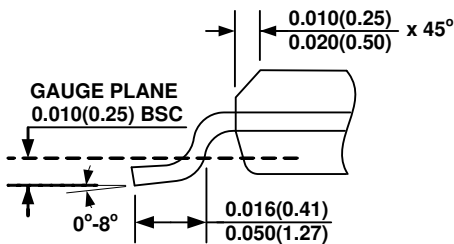

DETAIL "A"

NOTE:

- 1) CONTROL DIMENSION IS IN INCHES. DIMENSION IN BRACKET IS IN MILLIMETERS.
- 2) PACKAGE LENGTH DOES NOT INCLUDE MOLD FLASH, PROTRUSIONS OR GATE BURRS.
- 3) PACKAGE WIDTH DOES NOT INCLUDE INTERLEAD FLASH OR PROTRUSIONS.
- 4) LEAD COPLANARITY (BOTTOM OF LEADS AFTER FORMING) SHALL BE 0.004" INCHES MAX.
- 5) DRAWING CONFORMS TO JEDEC MS-012, VARIATION AA.
- 6) DRAWING IS NOT TO SCALE.

**NOTICE:** The information in this document is subject to change without notice. Please contact MPS for current specifications. Users should warrant and guarantee that third party Intellectual Property rights are not infringed upon when integrating MPS products into any application. MPS will not assume any legal responsibility for any said applications.