



Chipsmall Limited consists of a professional team with an average of over 10 year of expertise in the distribution of electronic components. Based in Hongkong, we have already established firm and mutual-benefit business relationships with customers from,Europe,America and south Asia,supplying obsolete and hard-to-find components to meet their specific needs.

With the principle of “Quality Parts,Customers Priority,Honest Operation,and Considerate Service”,our business mainly focus on the distribution of electronic components. Line cards we deal with include Microchip,ALPS,ROHM,Xilinx,Pulse,ON,Everlight and Freescale. Main products comprise IC,Modules,Potentiometer,IC Socket,Relay,Connector.Our parts cover such applications as commercial,industrial, and automotives areas.

We are looking forward to setting up business relationship with you and hope to provide you with the best service and solution. Let us make a better world for our industry!



Contact us

Tel: +86-755-8981 8866 Fax: +86-755-8427 6832

Email & Skype: info@chipsmall.com Web: www.chipsmall.com

Address: A1208, Overseas Decoration Building, #122 Zhenhua RD., Futian, Shenzhen, China



380MHz, SOT-23, Low Power Current Feedback Operational Amplifier

The HFA1155 is a low power, high-speed op amp and is the most recent addition to Intersil's HFA1XX5 series of low power op amps and buffers. Intersil's proprietary complementary bipolar UHF-1 process, coupled with the current feedback architecture deliver superb bandwidth even at very high gains (>250MHz at $A_V = 10$). The excellent video parameters make this amplifier ideal for professional video applications.

Though specified for $\pm 5V$ operation, the HFA1155 operates with single supply voltages as low as 4.5V, and requires only 1.4mA of I_{CC} in 5V applications (see Application Information section, and Application Note AN9897).

Ordering Information

PART NUMBER (BRAND)	TEMP. RANGE (°C)	PACKAGE	PKG. DWG. #
HFA1155IH96 (1155)	-40 to 85	5 Ld SOT-23 Tape and Reel	P5.064

Pinout

**HFA1155 (SOT23)
TOP VIEW**

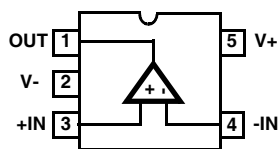

Features

- Low Power 5.5mA
- Low Distortion (10MHz, HD2) -53dBc
- -3dB Bandwidth 360MHz
- High Slew Rate 1650V/ μ s
- Fast Settling Time (0.1%) 38ns
- Excellent Gain Flatness ± 0.06 dB to 50MHz
- High Output Current 55mA
- Fast Overdrive Recovery <7ns
- Operates with 5V Single Supply (See AN9897)

Applications

- Video Switching and Routing
- Pulse and Video Amplifiers
- IF Signal Processing
- Flash A/D Driver
- Medical Imaging Systems
- Related Literature
 - AN9420, Current Feedback Theory
 - AN9897, Single 5V Supply Operation

HFA1155

Absolute Maximum Ratings $T_A = 25^\circ\text{C}$

Voltage Between V_+ and V_-	12V
Input Voltage	V_{SUPPLY}
Differential Input Voltage	5V
Output Current (50% Duty Cycle)	60mA
ESD Rating	
Human Body Model (Per MIL-STD-883 Method 3015.7)...	600V

Thermal Information

Thermal Resistance (Typical, Note 1)	θ_{JA} ($^\circ\text{C}/\text{W}$)
SOT-23 Package	225
Maximum Junction Temperature (Plastic Package)	150 $^\circ\text{C}$
Maximum Storage Temperature Range	-65 $^\circ\text{C}$ to 150 $^\circ\text{C}$
Maximum Lead Temperature (Soldering 10s)	300 $^\circ\text{C}$ (Lead Tips Only)

Operating Conditions

Temperature Range	-40 $^\circ\text{C}$ to 85 $^\circ\text{C}$
-------------------------	---

CAUTION: Stresses above those listed in "Absolute Maximum Ratings" may cause permanent damage to the device. This is a stress only rating and operation of the device at these or any other conditions above those indicated in the operational sections of this specification is not implied.

NOTE:

- θ_{JA} is measured with the component mounted on a low effective thermal conductivity test board in free air. See Tech Brief TB379 for details.

Electrical Specifications $V_{\text{SUPPLY}} = \pm 5\text{V}$, $A_V = +1$, $R_F = 510\Omega$, $R_L = 100\Omega$, Unless Otherwise Specified

PARAMETER	TEST CONDITIONS	(NOTE 2) TEST LEVEL	TEMP. ($^\circ\text{C}$)	MIN	TYP	MAX	UNITS
INPUT CHARACTERISTICS							
Input Offset Voltage		A	25	-	2	6	mV
		A	Full	-	-	10	mV
Input Offset Voltage Drift		C	Full	-	10	-	$\mu\text{V}/^\circ\text{C}$
V_{IO} CMRR	$\Delta V_{CM} = \pm 2\text{V}$	A	25	40	46	-	dB
		A	Full	38	-	-	dB
V_{IO} PSRR	$\Delta V_S = \pm 1.25\text{V}$	A	25	45	50	-	dB
		A	Full	42	-	-	dB
Non-Inverting Input Bias Current	$+I_N = 0\text{V}$	A	25	-	25	40	μA
		A	Full	-	-	65	μA
$+I_{BIAS}$ Drift		C	Full	-	40	-	$\text{nA}/^\circ\text{C}$
$+I_{BIAS}$ CMS	$\Delta V_{CM} = \pm 2\text{V}$	A	25	-	20	40	$\mu\text{A}/\text{V}$
		A	Full	-	-	50	$\mu\text{A}/\text{V}$
Inverting Input Bias Current	$-I_N = 0\text{V}$	A	25	-	12	50	μA
		A	Full	-	-	60	μA
$-I_{BIAS}$ Drift		C	Full	-	40	-	$\text{nA}/^\circ\text{C}$
$-I_{BIAS}$ CMS	$\Delta V_{CM} = \pm 2\text{V}$	A	25	-	1	7	$\mu\text{A}/\text{V}$
		A	Full	-	-	10	$\mu\text{A}/\text{V}$
$-I_{BIAS}$ PSS	$\Delta V_S = \pm 1.25\text{V}$	A	25	-	6	15	$\mu\text{A}/\text{V}$
		A	Full	-	-	27	$\mu\text{A}/\text{V}$
Non-Inverting Input Resistance		A	25	25	50	-	$\text{k}\Omega$
Inverting Input Resistance		C	25	-	40	-	Ω
Input Capacitance (Either Input)		B	25	-	2	-	pF
Input Common Mode Range		C	Full	± 2.5	± 3.0	-	V
Input Noise Voltage (Note 3)	100kHz	B	25	-	4.7	-	$\text{nV}/\sqrt{\text{Hz}}$
+Input Noise Current (Note 3)	100kHz	B	25	-	26	-	$\text{pA}/\sqrt{\text{Hz}}$
-Input Noise Current (Note 3)	100kHz	B	25	-	35	-	$\text{pA}/\sqrt{\text{Hz}}$
TRANSFER CHARACTERISTICS							
Open Loop Transimpedance Gain (Note 3)		B	25	-	630	-	$\text{k}\Omega$
Minimum Stable Gain		A	Full	1	-	-	V/V

Electrical Specifications $V_{SUPPLY} = \pm 5V$, $A_V = +1$, $R_F = 510\Omega$, $R_L = 100\Omega$, Unless Otherwise Specified (Continued)

PARAMETER	TEST CONDITIONS	(NOTE 2) TEST LEVEL	TEMP. (°C)	MIN	TYP	MAX	UNITS
AC CHARACTERISTICS $A_V = +2$, (Note 4) Unless Otherwise Specified							
-3dB Bandwidth ($V_{OUT} = 0.2V_{P-P}$, Note 3)	$A_V = -1$	B	25	-	360	-	MHz
	$A_V = +1$	B	25	-	365	-	MHz
	$A_V = +2$	B	25	-	355	-	MHz
-3dB Bandwidth ($V_{OUT} = 2V_{P-P}$)	$A_V = +2$	B	25	-	170	-	MHz
Gain Flatness ($V_{OUT} = 0.2V_{P-P}$, Note 3)	To 25MHz	B	25	-	± 0.06	-	dB
	To 50MHz	B	25	-	± 0.06	-	dB
	To 100MHz	B	25	-	± 0.1	-	dB
Full Power Bandwidth ($V_{OUT} = 5V_{P-P}$ at $A_V = +2$; $V_{OUT} = 4V_{P-P}$ at $A_V = +1$, Note 3)	$A_V = +1$	B	25	-	45	-	MHz
	$A_V = +2$	B	25	-	75	-	MHz
OUTPUT CHARACTERISTICS $A_V = +2$, (Note 4) Unless Otherwise Specified							
Output Voltage	$A_V = -1$	A	25	± 3.0	± 3.3	-	V
		A	Full	± 2.5	± 3.0	-	V
Output Current	$R_L = 50\Omega$, $A_V = -1$	A	25, 85	± 40	± 55	-	mA
		A	-40	± 35	± 50	-	mA
DC Closed Loop Output Resistance (Note 3)		B	25	-	0.09	-	Ω
2nd Harmonic Distortion (Note 3)	10MHz, $V_{OUT} = 2V_{P-P}$	B	25	-	-53	-	dBc
	20MHz, $V_{OUT} = 2V_{P-P}$	B	25	-	-47	-	dBc
3rd Harmonic Distortion (Note 3)	10MHz, $V_{OUT} = 2V_{P-P}$	B	25	-	-66	-	dBc
	20MHz, $V_{OUT} = 2V_{P-P}$	B	25	-	-60	-	dBc
TRANSIENT CHARACTERISTICS $A_V = +2$, (Note 4) Unless Otherwise Specified							
Rise and Fall Times	$V_{OUT} = 0.5V_{P-P}$	B	25	-	1.1	-	ns
Overshoot	$V_{OUT} = 0.5V_{P-P}$	B	25	-	11	-	%
Slew Rate ($V_{OUT} = 5V_{P-P}$ at $A_V = +2, -1$; $V_{OUT} = 4V_{P-P}$ at $A_V = +1$)	$A_V = -1$	B	25	-	1650	-	V/ μ s
	$A_V = +1$	B	25	-	270	-	V/ μ s
	$A_V = +2$	B	25	-	510	-	V/ μ s
Settling Time ($V_{OUT} = 2V$ to $0V$, Note 3)	To 0.1%	B	25	-	38	-	ns
	To 0.05%	B	25	-	50	-	ns
	To 0.01%	B	25	-	75	-	ns
Overdrive Recovery Time	$V_{IN} = \pm 2V$	B	25	-	7	-	ns
VIDEO CHARACTERISTICS $A_V = +2$, (Note 4) Unless Otherwise Specified							
Differential Gain	NTSC, $R_L = 150\Omega$	B	25	-	0.02	-	%
	NTSC, $R_L = 75\Omega$	B	25	-	0.02	-	%
Differential Phase	NTSC, $R_L = 150\Omega$	B	25	-	0.06	-	Degrees
	NTSC, $R_L = 75\Omega$	B	25	-	0.12	-	Degrees
POWER SUPPLY CHARACTERISTICS							
Power Supply Range	Note 5	B	Full	± 2.25	-	± 5.5	V
Power Supply Current (Note 3)		A	Full	-	5.5	8	mA

NOTES:

2. Test Level: A. Production Tested; B. Typical or Guaranteed Limit Based on Characterization; C. Design Typical for Information Only.
3. See Typical Performance Curves for more information.
4. The feedback resistor value depends on closed loop gain. See the "Optimum Feedback Resistor" table in the Application Information section for values used for characterization.
5. The minimum supply voltage entry is a typical value.

Application Information

Relevant Application Notes

The following Application Notes pertain to the HFA1155:

- AN9787-An Intuitive Approach to Understanding Current Feedback Amplifiers
- AN9420-Current Feedback Amplifier Theory and Applications
- AN9663-Converting from Voltage Feedback to Current Feedback Amplifiers
- AN9897-Operating the HFA1155 from 5V Single Supply

These publications may be obtained from Intersil's web site (www.intersil.com).

Performance Differences Between Packages

The HFA1155 is a high frequency current feedback amplifier. As such, it is sensitive to parasitic capacitances which influence the amplifier's operation. The different parasitic capacitances of different packages yield performance differences (notably bandwidth and bandwidth related parameters).

Because of these performance differences, designers should evaluate and breadboard with the same package style to be used in production.

Optimum Feedback Resistor

The enclosed frequency response graphs detail the performance of the HFA1155 in various gains. Although the bandwidth dependency on A_{CL} isn't as severe as that of a voltage feedback amplifier, there is an appreciable decrease in bandwidth at higher gains. This decrease can be minimized by taking advantage of the current feedback amplifier's unique relationship between bandwidth and R_F . All current feedback amplifiers require a feedback resistor, even for unity gain applications, and the R_F , in conjunction with the internal compensation capacitor, sets the dominant pole of the frequency response. Thus, the amplifier's bandwidth is inversely proportional to R_F . The HFA1155 is optimized for $R_F = 604\Omega$, at a gain of +2. Decreasing R_F decreases stability, resulting in excessive peaking and overshoot (Note: Capacitive feedback causes the same problems due to the feedback impedance decrease at higher frequencies). At higher gains the amplifier is more stable, so R_F can be decreased in a trade-off of stability for bandwidth. The table below lists recommended R_F values for various gains, and the expected bandwidth.

OPTIMUM FEEDBACK RESISTOR

A_{CL}	R_F (Ω) SOT-23	BANDWIDTH (MHz) SOT-23
-1	576	360
+1	453, (+ $R_S = 221$)	365
+2	604	355
+5	475	300
+10	182	250

5V Single Supply Operation

This amplifier operates at single supply voltages down to 4.5V. The dramatic supply current reduction at this operating condition (refer also to Figure 16) makes this op amp an even better choice for low power 5V systems. Refer to Application Note AN9897 for further information.

Driving Capacitive Loads

Capacitive loads, such as an A/D input, or an improperly terminated transmission line will degrade the amplifier's phase margin resulting in frequency response peaking and possible oscillations. In most cases, the oscillation can be avoided by placing a resistor (R_S) in series with the output prior to the capacitance.

Figure 1 details starting points for the selection of this resistor. The points on the curve indicate the R_S and C_L combinations for the optimum bandwidth, stability, and settling time, but experimental fine tuning is recommended. Picking a point above or to the right of the curve yields an overdamped response, while points below or left of the curve indicate areas of underdamped performance.

R_S and C_L form a low pass network at the output, thus limiting system bandwidth well below the amplifier bandwidth of 355MHz ($A_V = +2$). By decreasing R_S as C_L increases (as illustrated by the curves), the maximum bandwidth is obtained without sacrificing stability. In spite of this, bandwidth still decreases as the load capacitance increases. For example, at $A_V = +2$, $R_S = 30\Omega$, $C_L = 22\text{pF}$, the bandwidth is 290MHz, but the bandwidth drops to 90MHz at $A_V = +2$, $R_S = 6\Omega$, $C_L = 390\text{pF}$.

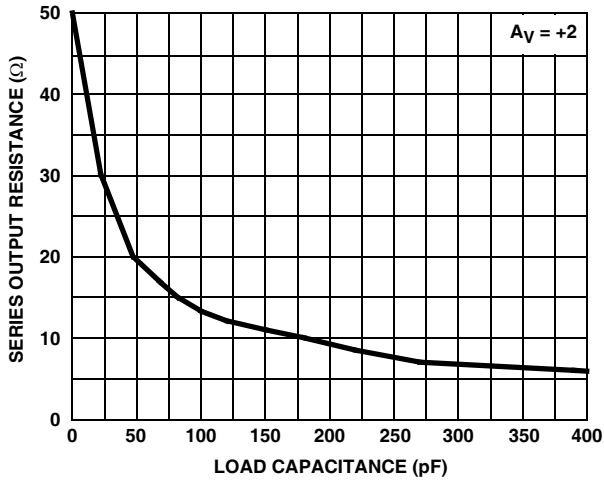

FIGURE 1. RECOMMENDED SERIES OUTPUT RESISTOR vs LOAD CAPACITANCE

PC Board Layout

The frequency response of this amplifier depends greatly on the amount of care taken in designing the PC board. **The use of low inductance components such as chip resistors and chip capacitors is strongly recommended, while a solid ground plane is a must!**

Attention should be given to decoupling the power supplies. A large value (10μF) tantalum in parallel with a small value chip (0.1μF) capacitor works well in most cases.

Terminated microstrip signal lines are recommended at the input and output of the device. Output capacitance, such as that resulting from an improperly terminated transmission line, will degrade the frequency response of the amplifier and may cause oscillations. In most cases, the oscillation can be avoided by placing a resistor in series with the output.

Care must also be taken to minimize the capacitance to ground seen by the amplifier's inverting input. The larger this capacitance, the worse the gain peaking, resulting in pulse overshoot and eventual instability. To reduce this capacitance, remove the ground plane under traces connected to -IN and keep these traces as short as possible.

Typical Performance Curves

V_{SUPPLY} = ±5V, R_F = Value From the "Optimum Feedback Resistor" Table, T_A = 25°C, R_L = 100Ω, Unless Otherwise Specified

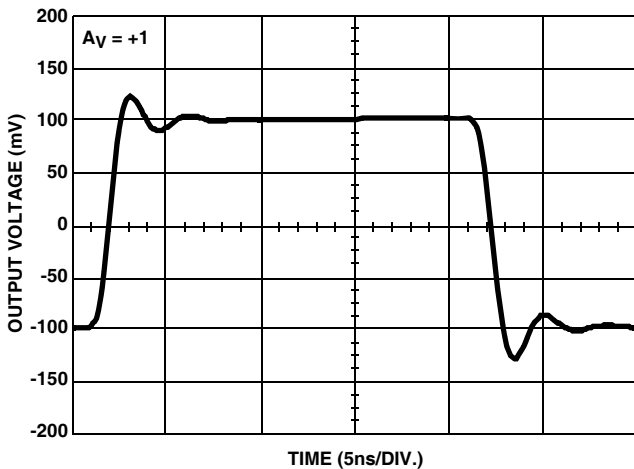

FIGURE 2. SMALL SIGNAL PULSE RESPONSE

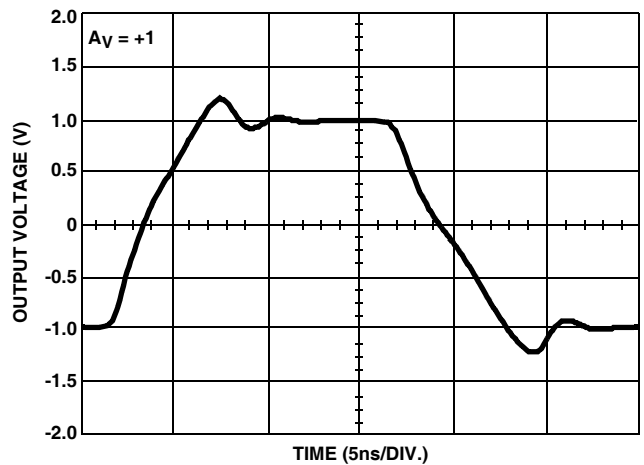

FIGURE 3. LARGE SIGNAL PULSE RESPONSE

Typical Performance Curves

$V_{SUPPLY} = \pm 5V$, $R_F =$ Value From the "Optimum Feedback Resistor" Table, $T_A = 25^\circ C$,
 $R_L = 100\Omega$, Unless Otherwise Specified (Continued)

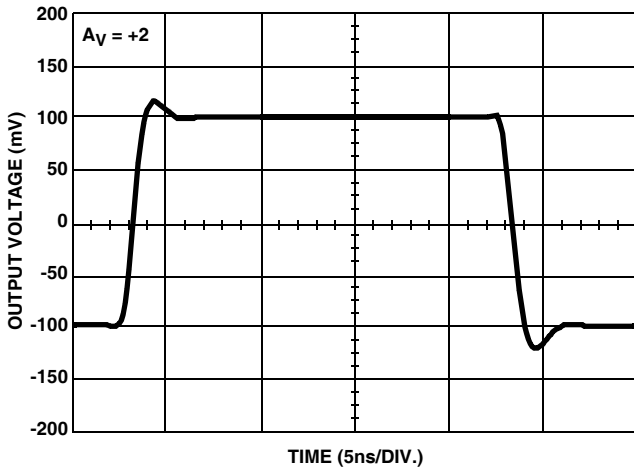

FIGURE 4. SMALL SIGNAL PULSE RESPONSE

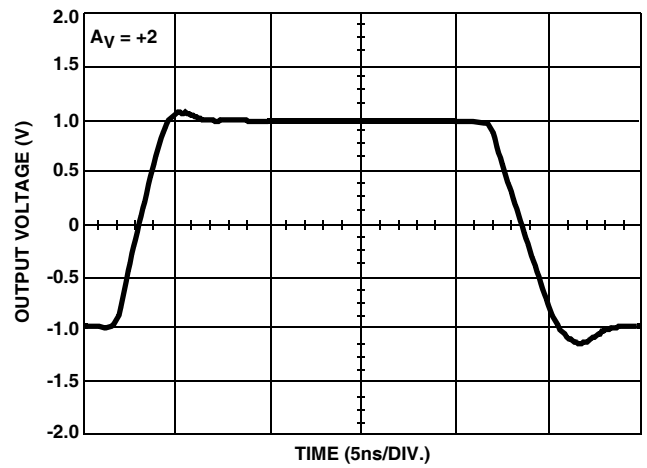

FIGURE 5. LARGE SIGNAL PULSE RESPONSE

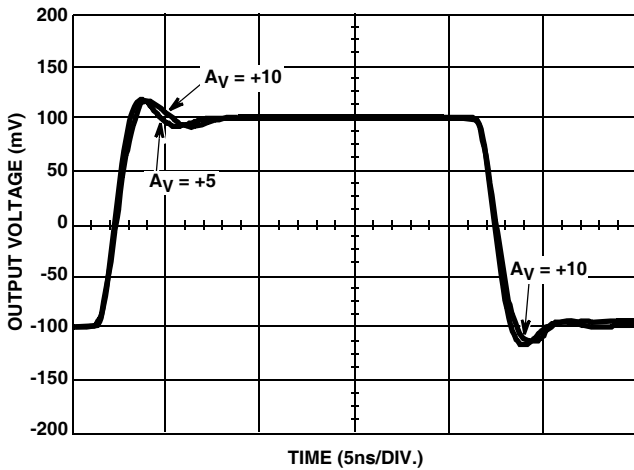

FIGURE 6. SMALL SIGNAL PULSE RESPONSE

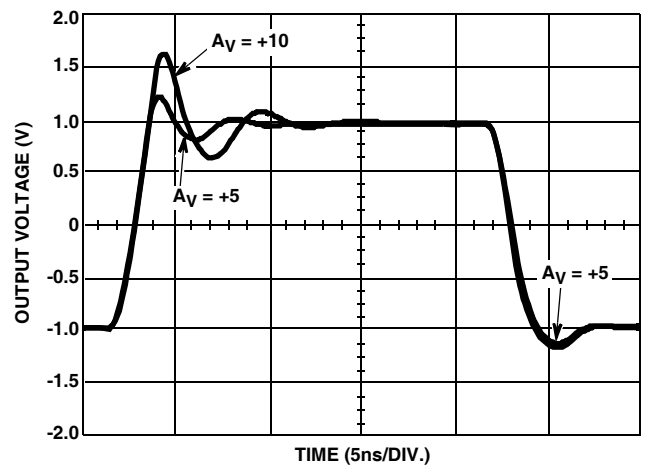

FIGURE 7. LARGE SIGNAL PULSE RESPONSE

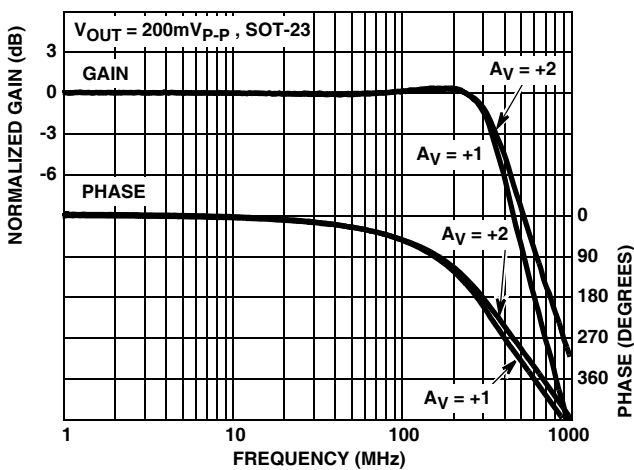

FIGURE 8. FREQUENCY RESPONSE

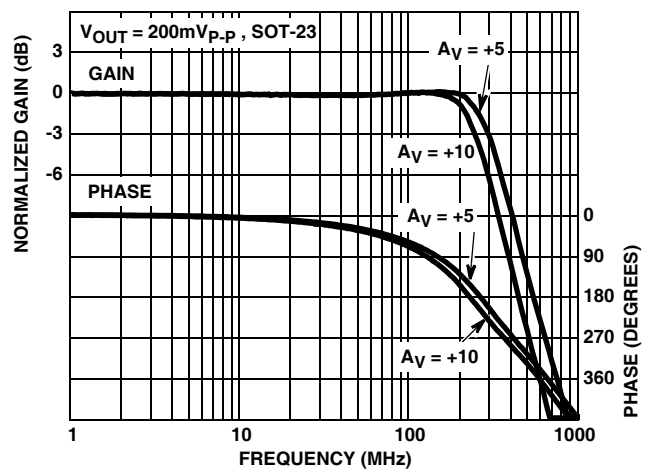

FIGURE 9. FREQUENCY RESPONSE

Typical Performance Curves

$V_{SUPPLY} = \pm 5V$, $R_F =$ Value From the "Optimum Feedback Resistor" Table, $T_A = 25^\circ C$,
 $R_L = 100\Omega$, Unless Otherwise Specified (Continued)

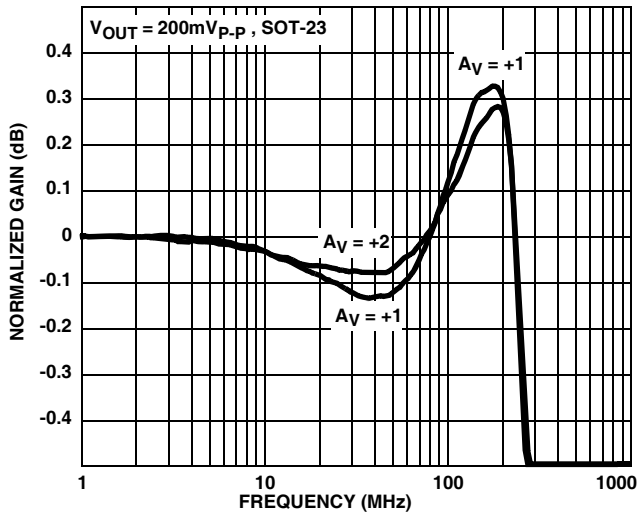

FIGURE 10. GAIN FLATNESS

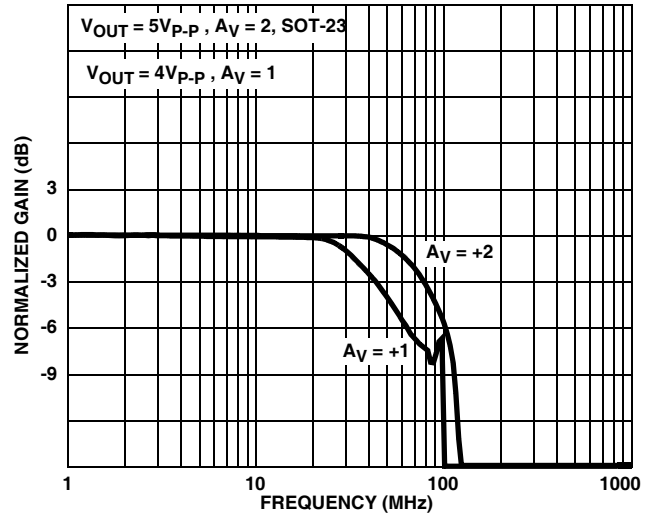

FIGURE 11. FULL POWER BANDWIDTH

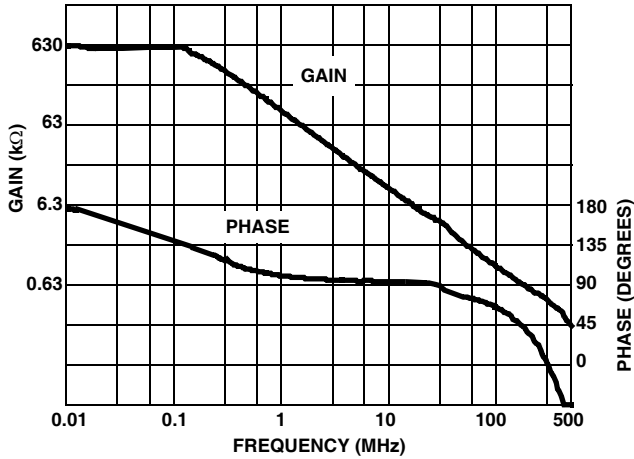

FIGURE 12. OPEN LOOP TRANSIMPEDANCE

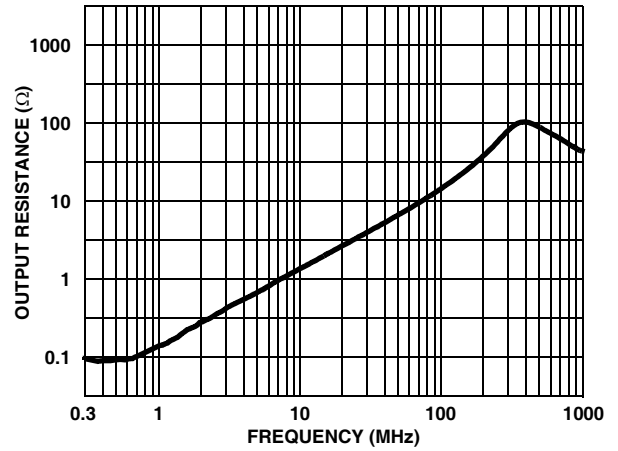

FIGURE 13. CLOSED LOOP OUTPUT RESISTANCE

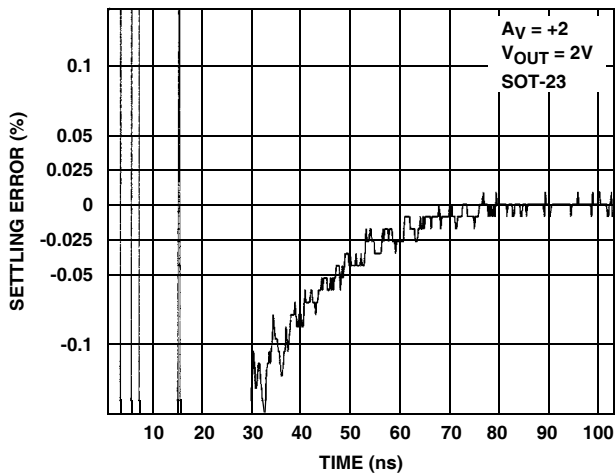

FIGURE 14. SETTLING RESPONSE

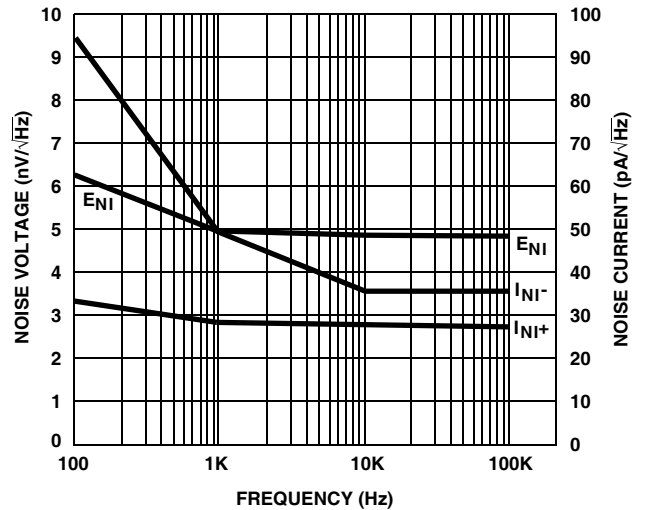

FIGURE 15. INPUT NOISE vs FREQUENCY

Typical Performance Curves

$V_{SUPPLY} = \pm 5V$, $R_F =$ Value From the "Optimum Feedback Resistor" Table, $T_A = 25^\circ C$,
 $R_L = 100\Omega$, Unless Otherwise Specified **(Continued)**

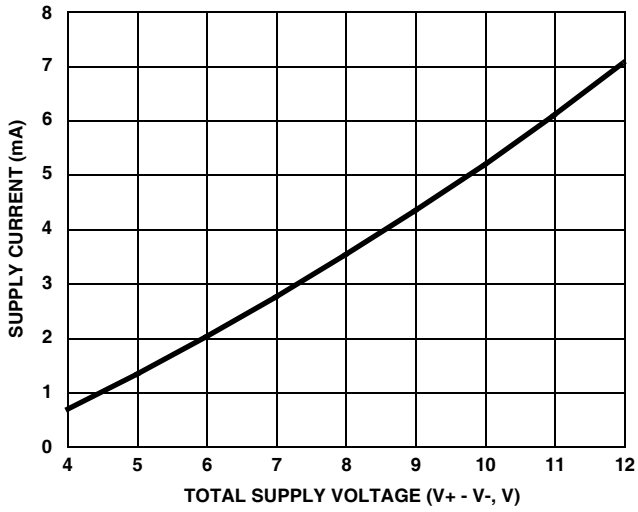

FIGURE 16. SUPPLY CURRENT vs SUPPLY VOLTAGE

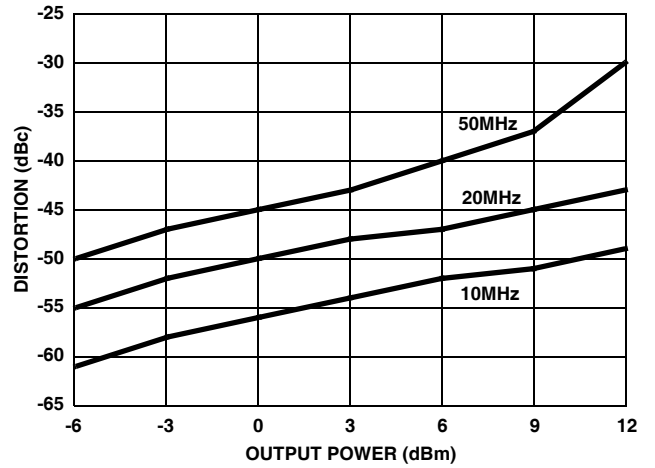

FIGURE 17. 2nd HARMONIC DISTORTION vs P_{OUT}

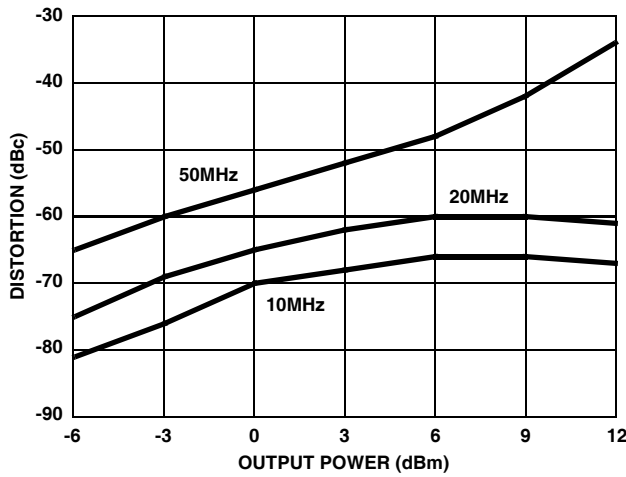
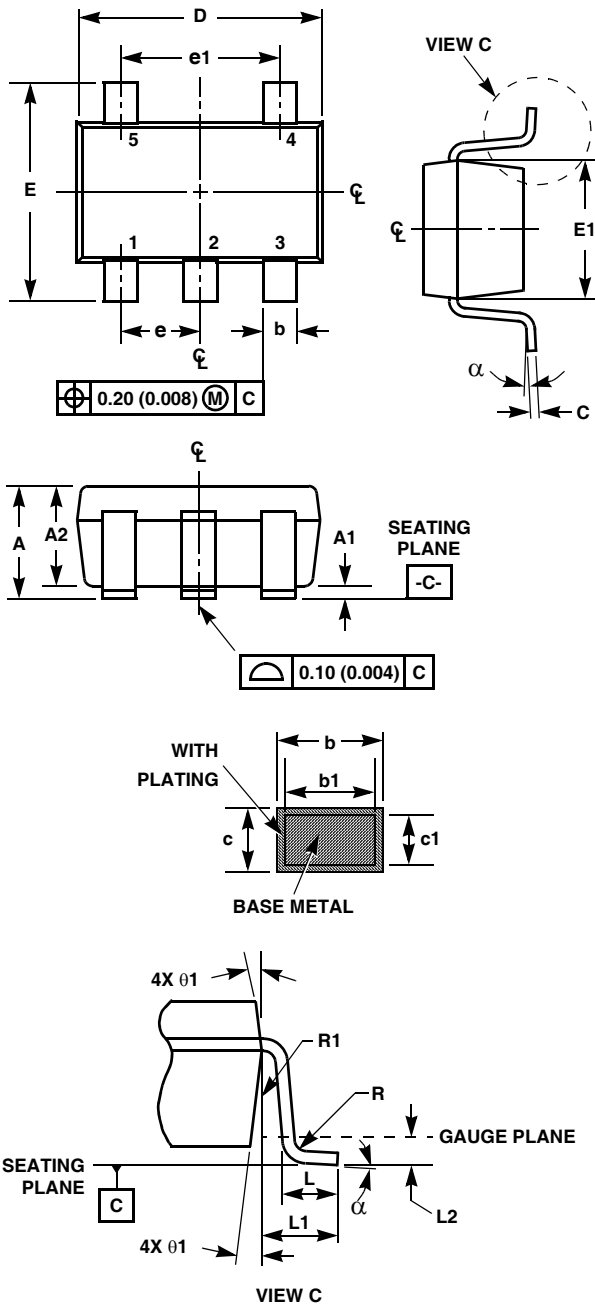

FIGURE 18. 3rd HARMONIC DISTORTION vs P_{OUT}

Small Outline Transistor Plastic Packages (SOT23-5)



P5.064

5 LEAD SMALL OUTLINE TRANSISTOR PLASTIC PACKAGE

SYMBOL	INCHES		MILLIMETERS		NOTES
	MIN	MAX	MIN	MAX	
A	0.036	0.057	0.90	1.45	-
A1	0.000	0.0059	0.00	0.15	-
A2	0.036	0.051	0.90	1.30	-
b	0.012	0.020	0.30	0.50	-
b1	0.012	0.018	0.30	0.45	-
c	0.003	0.009	0.08	0.22	6
c1	0.003	0.008	0.08	0.20	6
D	0.111	0.118	2.80	3.00	3
E	0.103	0.118	2.60	3.00	-
E1	0.060	0.067	1.50	1.70	3
e	0.0374 Ref		0.95 Ref		-
e1	0.0748 Ref		1.90 Ref		-
L	0.014	0.022	0.35	0.55	4
L1	0.024 Ref.		0.60 Ref.		
L2	0.010 Ref.		0.25 Ref.		
N	5		5		5
R	0.004	-	0.10	-	
R1	0.004	0.010	0.10	0.25	
α	0°	8°	0°	8°	-

Rev. 2 9/03

NOTES:

1. Dimensioning and tolerance per ASME Y14.5M-1994.
2. Package conforms to EIAJ SC-74 and JEDEC MO178AA.
3. Dimensions D and E1 are exclusive of mold flash, protrusions, or gate burrs.
4. Footlength L measured at reference to gauge plane.
5. "N" is the number of terminal positions.
6. These Dimensions apply to the flat section of the lead between 0.08mm and 0.15mm from the lead tip.
7. Controlling dimension: MILLIMETER. Converted inch dimensions are for reference only.

All Intersil U.S. products are manufactured, assembled and tested utilizing ISO9000 quality systems. Intersil Corporation's quality certifications can be viewed at www.intersil.com/design/quality

Intersil products are sold by description only. Intersil Corporation reserves the right to make changes in circuit design, software and/or specifications at any time without notice. Accordingly, the reader is cautioned to verify that data sheets are current before placing orders. Information furnished by Intersil is believed to be accurate and reliable. However, no responsibility is assumed by Intersil or its subsidiaries for its use; nor for any infringements of patents or other rights of third parties which may result from its use. No license is granted by implication or otherwise under any patent or patent rights of Intersil or its subsidiaries.

For information regarding Intersil Corporation and its products, see www.intersil.com