



Chipsmall Limited consists of a professional team with an average of over 10 year of expertise in the distribution of electronic components. Based in Hongkong, we have already established firm and mutual-benefit business relationships with customers from,Europe,America and south Asia,supplying obsolete and hard-to-find components to meet their specific needs.

With the principle of “Quality Parts,Customers Priority,Honest Operation,and Considerate Service”,our business mainly focus on the distribution of electronic components. Line cards we deal with include Microchip,ALPS,ROHM,Xilinx,Pulse,ON,Everlight and Freescale. Main products comprise IC,Modules,Potentiometer,IC Socket,Relay,Connector.Our parts cover such applications as commercial,industrial, and automotives areas.

We are looking forward to setting up business relationship with you and hope to provide you with the best service and solution. Let us make a better world for our industry!



Contact us

Tel: +86-755-8981 8866 Fax: +86-755-8427 6832

Email & Skype: info@chipsmall.com Web: www.chipsmall.com

Address: A1208, Overseas Decoration Building, #122 Zhenhua RD., Futian, Shenzhen, China



Ultra High Frequency Transistor Arrays

The HFA3046, HFA3096, HFA3127 and the HFA3128 are Ultra High Frequency Transistor Arrays that are fabricated from Intersil Corporation’s complementary bipolar UHF-1 process. Each array consists of five dielectrically isolated transistors on a common monolithic substrate. The NPN transistors exhibit a f_T of 8GHz while the PNP transistors provide a f_T of 5.5GHz. Both types exhibit low noise (3.5dB), making them ideal for high frequency amplifier and mixer applications.

The HFA3046 and HFA3127 are all NPN arrays while the HFA3128 has all PNP transistors. The HFA3096 is an NPN-PNP combination. Access is provided to each of the terminals for the individual transistors for maximum application flexibility. Monolithic construction of these transistor arrays provides close electrical and thermal matching of the five transistors.

Intersil provides an Application Note illustrating the use of these devices as RF amplifiers. For more information, visit our website at www.intersil.com.

Features

- NPN Transistor (f_T) 8GHz
- NPN Current Gain (h_{FE}). 130
- NPN Early Voltage (V_A) 50V
- PNP Transistor (f_T). 5.5GHz
- PNP Current Gain (h_{FE}). 60
- PNP Early Voltage (V_A) 20V
- Noise Figure (50Ω) at 1.0GHz 3.5dB
- Collector to Collector Leakage <1pA
- Complete Isolation Between Transistors
- Pin Compatible with Industry Standard 3XXX Series Arrays
- Pb-Free (RoHS Compliant)

Applications

- VHF/UHF Amplifiers
- VHF/UHF Mixers
- IF Converters
- Synchronous Detectors

Ordering Information

| PART NUMBER (Note) | PART MARKING | TEMP. RANGE (°C) | PACKAGE (Pb-free) | PKG. DWG. # |
|--|--------------|---------------------|----------------------|----------------|
| HFA3046BZ | HFA3046BZ | -55 to +125 | 14 Ld SOIC | M14.15 |
| HFA3096BZ* | HFA3096BZ | -55 to +125 | 16 Ld SOIC | M16.15 |
| HFA3127BZ* | HFA3127BZ | -55 to +125 | 16 Ld SOIC | M16.15 |
| HFA3127RZ* | 127Z | -55 to +125 | 16 Ld 3x3 QFN | L16.3x3 |
| HFA3128BZ (No longer available or supported) | HFA3128BZ | -55 to +125 | 16 Ld SOIC | M16.15 |
| HFA3128RZ (No longer available or supported) | 128Z | -55 to +125 | 16 Ld 3x3 QFN | L16.3x3 |

*Add “96” suffix for tape and reel.

NOTE: These Intersil Pb-free plastic packaged products employ special Pb-free material sets, molding compounds/die attach materials, and 100% matte tin plate plus anneal (e3 termination finish, which is RoHS compliant and compatible with both SnPb and Pb-free soldering operations). Intersil Pb-free products are MSL classified at Pb-free peak reflow temperatures that meet or exceed the Pb-free requirements of IPC/JEDEC J STD-020.

Pinouts

HFA3046
(14 LD SOIC)
TOP VIEW

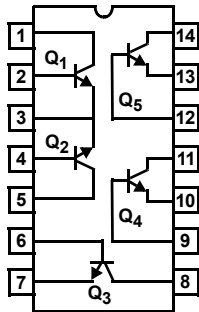

HFA3096
(16 LD SOIC)
TOP VIEW

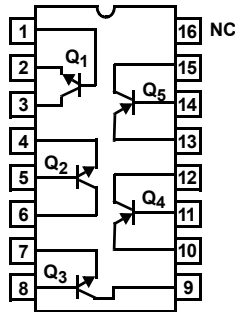

HFA3127
(16 LD SOIC)
TOP VIEW

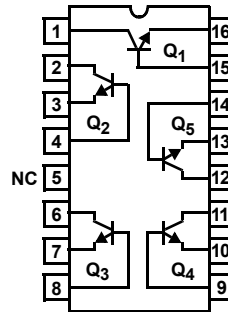

HFA3128
(16 LD SOIC)
TOP VIEW

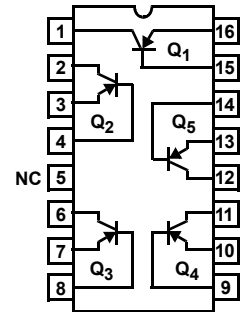

HFA3127, HFA3128
(16 LD 3X3 QFN)
TOP VIEW

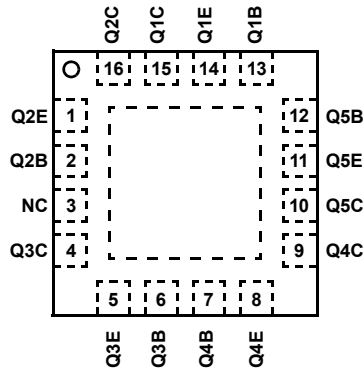

HFA3046, HFA3096, HFA3127, HFA3128

Absolute Maximum Ratings

| | |
|--|--|
| Collector to Emitter Voltage (Open Base) | 8V |
| Collector to Base Voltage (Open Emitter) | 12V |
| Emitter to Base Voltage (Reverse Bias) | 5.5V |
| Collector Current (100% Duty Cycle) | 18.5mA at $T_J = +150^{\circ}\text{C}$ |
| | 34mA at $T_J = +125^{\circ}\text{C}$ |
| | 37mA at $T_J = +110^{\circ}\text{C}$ |
| Peak Collector Current (Any Condition) | 65mA |

Thermal Information

| | | |
|---|---|---|
| Thermal Resistance (Typical) | θ_{JA} ($^{\circ}\text{C}/\text{W}$) | θ_{JC} ($^{\circ}\text{C}/\text{W}$) |
| 14 Ld SOIC Package (Note 1) | 120 | N/A |
| 16 Ld SOIC Package (Note 1) | 115 | N/A |
| QFN Package (Notes 2, 3) | 57 | 10 |
| Maximum Power Dissipation (Any One Transistor) | 0.15W | |
| Maximum Junction Temperature (Die) | $+175^{\circ}\text{C}$ | |
| Maximum Junction Temperature (Plastic Package) | $+150^{\circ}\text{C}$ | |
| Maximum Storage Temperature Range | -65°C to $+150^{\circ}\text{C}$ | |
| Pb-Free Reflow Profile see link below | | |
| http://www.intersil.com/pbfree/Pb-FreeReflow.asp | | |

Operating Information

Temperature Range

CAUTION: Stresses above those listed in "Absolute Maximum Ratings" may cause permanent damage to the device. This is a stress only rating and operation of the device at these or any other conditions above those indicated in the operational sections of this specification is not implied.

NOTES:

- θ_{JA} is measured with the component mounted on an evaluation PC board in free air.
- For θ_{JC} , the "case temp" location is the center of the exposed metal pad on the package underside.
- θ_{JA} is measured with the component mounted on a high effective thermal conductivity test board in free air. See Tech Brief [TB379](#) for details.

Electrical Specifications $T_A = +25^{\circ}\text{C}$

| PARAMETER | TEST CONDITIONS | DIE | | | SOIC, QFN | | | UNITS |
|--|--|-----|------|------|-----------|------|------|------------------------|
| | | MIN | TYP | MAX | MIN | TYP | MAX | |
| DC NPN CHARACTERISTICS | | | | | | | | |
| Collector to Base Breakdown Voltage, $V_{(BR)CBO}$ | $I_C = 100\mu\text{A}$, $I_E = 0$ | 12 | 18 | - | 12 | 18 | - | V |
| Collector to Emitter Breakdown Voltage, $V_{(BR)CEO}$ | $I_C = 100\mu\text{A}$, $I_B = 0$ | 8 | 12 | - | 8 | 12 | - | V |
| Collector to Emitter Breakdown Voltage, $V_{(BR)CES}$ | $I_C = 100\mu\text{A}$, Base Shorted to Emitter | 10 | 20 | - | 10 | 20 | - | V |
| Emitter to Base Breakdown Voltage, $V_{(BR)EBO}$ | $I_E = 10\mu\text{A}$, $I_C = 0$ | 5.5 | 6 | - | 5.5 | 6 | - | V |
| Collector-Cutoff-Current, I_{CEO} | $V_{CE} = 6\text{V}$, $I_B = 0$ | - | 2 | 100 | - | 2 | 100 | nA |
| Collector-Cutoff-Current, I_{CBO} | $V_{CB} = 8\text{V}$, $I_E = 0$ | - | 0.1 | 10 | - | 0.1 | 10 | nA |
| Collector to Emitter Saturation Voltage, $V_{CE(SAT)}$ | $I_C = 10\text{mA}$, $I_B = 1\text{mA}$ | - | 0.3 | 0.5 | - | 0.3 | 0.5 | V |
| Base to Emitter Voltage, V_{BE} | $I_C = 10\text{mA}$ | - | 0.85 | 0.95 | - | 0.85 | 0.95 | V |
| DC Forward-Current Transfer Ratio, h_{FE} | $I_C = 10\text{mA}$, $V_{CE} = 2\text{V}$ | 40 | 130 | - | 40 | 130 | - | |
| Early Voltage, V_A | $I_C = 1\text{mA}$, $V_{CE} = 3.5\text{V}$ | 20 | 50 | - | 20 | 50 | - | V |
| Base to Emitter Voltage Drift | $I_C = 10\text{mA}$ | - | -1.5 | - | - | -1.5 | - | mV/ $^{\circ}\text{C}$ |
| Collector to Collector Leakage | | - | 1 | - | - | 1 | - | pA |

Electrical Specifications $T_A = +25^{\circ}\text{C}$

| PARAMETER | TEST CONDITIONS | DIE | | | SOIC, QFN | | | UNITS |
|--------------------------------------|--|-----|-----|-----|-----------|-----|-----|-------|
| | | MIN | TYP | MAX | MIN | TYP | MAX | |
| DYNAMIC NPN CHARACTERISTICS | | | | | | | | |
| Noise Figure | $f = 1.0\text{GHz}$, $V_{CE} = 5\text{V}$, $I_C = 5\text{mA}$, $Z_S = 50\Omega$ | - | 3.5 | - | - | 3.5 | - | dB |
| f_T Current Gain-Bandwidth Product | $I_C = 1\text{mA}$, $V_{CE} = 5\text{V}$ | - | 5.5 | - | - | 5.5 | - | GHz |
| | $I_C = 10\text{mA}$, $V_{CE} = 5\text{V}$ | - | 8 | - | - | 8 | - | GHz |

HFA3046, HFA3096, HFA3127, HFA3128

Electrical Specifications $T_A = +25^\circ\text{C}$ (Continued)

| PARAMETER | TEST CONDITIONS | DIE | | | SOIC, QFN | | | UNITS |
|--|---|-----|-----|-----|-----------|-----|-----|-------|
| | | MIN | TYP | MAX | MIN | TYP | MAX | |
| Power Gain-Bandwidth Product, f_{MAX} | $I_C = 10\text{mA}$, $V_{\text{CE}} = 5\text{V}$ | - | 6 | - | - | 2.5 | - | GHz |
| Base to Emitter Capacitance | $V_{\text{BE}} = -3\text{V}$ | - | 200 | - | - | 500 | - | fF |
| Collector to Base Capacitance | $V_{\text{CB}} = 3\text{V}$ | - | 200 | - | - | 500 | - | fF |

Electrical Specifications $T_A = +25^\circ\text{C}$

| PARAMETER | TEST CONDITIONS | DIE | | | SOIC, QFN | | | UNITS |
|--|--|-----|------|------|-----------|------|------|----------------------------|
| | | MIN | TYP | MAX | MIN | TYP | MAX | |
| DC PNP CHARACTERISTICS | | | | | | | | |
| Collector to Base Breakdown Voltage, $V_{(\text{BR})\text{CBO}}$ | $I_C = -100\mu\text{A}$, $I_E = 0$ | 10 | 15 | - | 10 | 15 | - | V |
| Collector to Emitter Breakdown Voltage, $V_{(\text{BR})\text{CEO}}$ | $I_C = -100\mu\text{A}$, $I_B = 0$ | 8 | 15 | - | 8 | 15 | - | V |
| Collector to Emitter Breakdown Voltage, $V_{(\text{BR})\text{CES}}$ | $I_C = -100\mu\text{A}$, Base Shorted to Emitter | 10 | 15 | - | 10 | 15 | - | V |
| Emitter to Base Breakdown Voltage, $V_{(\text{BR})\text{EBO}}$ | $I_E = -10\mu\text{A}$, $I_C = 0$ | 4.5 | 5 | - | 4.5 | 5 | - | V |
| Collector Cutoff Current, I_{CEO} | $V_{\text{CE}} = -6\text{V}$, $I_B = 0$ | - | 2 | 100 | - | 2 | 100 | nA |
| Collector Cutoff Current, I_{CBO} | $V_{\text{CB}} = -8\text{V}$, $I_E = 0$ | - | 0.1 | 10 | - | 0.1 | 10 | nA |
| Collector to Emitter Saturation Voltage, $V_{\text{CE}(\text{SAT})}$ | $I_C = -10\text{mA}$, $I_B = -1\text{mA}$ | - | 0.3 | 0.5 | - | 0.3 | 0.5 | V |
| Base to Emitter Voltage, V_{BE} | $I_C = -10\text{mA}$ | - | 0.85 | 0.95 | - | 0.85 | 0.95 | V |
| DC Forward-Current Transfer Ratio, h_{FE} | $I_C = -10\text{mA}$, $V_{\text{CE}} = -2\text{V}$ | 20 | 60 | - | 20 | 60 | - | |
| Early Voltage, V_A | $I_C = -1\text{mA}$, $V_{\text{CE}} = -3.5\text{V}$ | 10 | 20 | - | 10 | 20 | - | V |
| Base to Emitter Voltage Drift | $I_C = -10\text{mA}$ | - | -1.5 | - | - | -1.5 | - | $\text{mV}/^\circ\text{C}$ |
| Collector to Collector Leakage | | - | 1 | - | - | 1 | - | pA |

Electrical Specifications $T_A = +25^\circ\text{C}$

| PARAMETER | TEST CONDITIONS | DIE | | | SOIC, QFN | | | UNITS |
|--------------------------------------|--|-----|-----|-----|-----------|-----|-----|-------|
| | | MIN | TYP | MAX | MIN | TYP | MAX | |
| DYNAMIC PNP CHARACTERISTICS | | | | | | | | |
| Noise Figure | $f = 1.0\text{GHz}$, $V_{\text{CE}} = -5\text{V}$, $I_C = -5\text{mA}$, $Z_S = 50\Omega$ | - | 3.5 | - | - | 3.5 | - | dB |
| f_T Current Gain-Bandwidth Product | $I_C = -1\text{mA}$, $V_{\text{CE}} = -5\text{V}$ | - | 2 | - | - | 2 | - | GHz |
| | $I_C = -10\text{mA}$, $V_{\text{CE}} = -5\text{V}$ | - | 5.5 | - | - | 5.5 | - | GHz |
| Power Gain-Bandwidth Product | $I_C = -10\text{mA}$, $V_{\text{CE}} = -5\text{V}$ | - | 3 | - | - | 2 | - | GHz |
| Base to Emitter Capacitance | $V_{\text{BE}} = 3\text{V}$ | - | 200 | - | - | 500 | - | fF |
| Collector to Base Capacitance | $V_{\text{CB}} = -3\text{V}$ | - | 300 | - | - | 600 | - | fF |

HFA3046, HFA3096, HFA3127, HFA3128

Electrical Specifications $T_A = +25^\circ\text{C}$ (Continued)

| PARAMETER | TEST CONDITIONS | DIE | | | SOIC, QFN | | | UNITS |
|---|--|-----|-----|-----|-----------|-----|-----|------------------------------|
| | | MIN | TYP | MAX | MIN | TYP | MAX | |
| DIFFERENTIAL PAIR MATCHING CHARACTERISTICS FOR THE HFA3046 | | | | | | | | |
| Input Offset Voltage | $I_C = 10\text{mA}$, $V_{CE} = 5\text{V}$ | - | 1.5 | 5.0 | - | 1.5 | 5.0 | mV |
| Input Offset Current | $I_C = 10\text{mA}$, $V_{CE} = 5\text{V}$ | - | 5 | 25 | - | 5 | 25 | μA |
| Input Offset Voltage TC | $I_C = 10\text{mA}$, $V_{CE} = 5\text{V}$ | - | 0.5 | - | - | 0.5 | - | $\mu\text{V}/^\circ\text{C}$ |

S-Parameter and PSPICE model data is available from Intersil Sales Offices, and Intersil Corporation's web site.

Common Emitter S-Parameters of NPN $3\mu\text{m} \times 50\mu\text{m}$ Transistor

| FREQ. (Hz) | $ S_{11} $ | PHASE(S_{11}) | $ S_{21} $ | PHASE(S_{21}) | $ S_{12} $ | PHASE(S_{12}) | $ S_{22} $ | PHASE(S_{22}) |
|--|------------|-------------------|------------|-------------------|------------|-------------------|------------|-------------------|
| $V_{CE} = 5\text{V}$ and $I_C = 5\text{mA}$ | | | | | | | | |
| 1.0E+08 | 0.83 | -11.78 | 11.07 | 168.57 | 1.41E-02 | 78.88 | 0.97 | -11.05 |
| 2.0E+08 | 0.79 | -22.82 | 10.51 | 157.89 | 2.69E-02 | 68.63 | 0.93 | -21.35 |
| 3.0E+08 | 0.73 | -32.64 | 9.75 | 148.44 | 3.75E-02 | 59.58 | 0.86 | -30.44 |
| 4.0E+08 | 0.67 | -41.08 | 8.91 | 140.36 | 4.57E-02 | 51.90 | 0.79 | -38.16 |
| 5.0E+08 | 0.61 | -48.23 | 8.10 | 133.56 | 5.19E-02 | 45.50 | 0.73 | -44.59 |
| 6.0E+08 | 0.55 | -54.27 | 7.35 | 127.88 | 5.65E-02 | 40.21 | 0.67 | -49.93 |
| 7.0E+08 | 0.50 | -59.41 | 6.69 | 123.10 | 6.00E-02 | 35.82 | 0.62 | -54.37 |
| 8.0E+08 | 0.46 | -63.81 | 6.11 | 119.04 | 6.27E-02 | 32.15 | 0.57 | -58.10 |
| 9.0E+08 | 0.42 | -67.63 | 5.61 | 115.57 | 6.47E-02 | 29.07 | 0.53 | -61.25 |
| 1.0E+09 | 0.39 | -70.98 | 5.17 | 112.55 | 6.63E-02 | 26.45 | 0.50 | -63.96 |
| 1.1E+09 | 0.36 | -73.95 | 4.79 | 109.91 | 6.75E-02 | 24.19 | 0.47 | -66.31 |
| 1.2E+09 | 0.34 | -76.62 | 4.45 | 107.57 | 6.85E-02 | 22.24 | 0.45 | -68.37 |
| 1.3E+09 | 0.32 | -79.04 | 4.15 | 105.47 | 6.93E-02 | 20.53 | 0.43 | -70.19 |
| 1.4E+09 | 0.30 | -81.25 | 3.89 | 103.57 | 7.00E-02 | 19.02 | 0.41 | -71.83 |
| 1.5E+09 | 0.28 | -83.28 | 3.66 | 101.84 | 7.05E-02 | 17.69 | 0.40 | -73.31 |
| 1.6E+09 | 0.27 | -85.17 | 3.45 | 100.26 | 7.10E-02 | 16.49 | 0.39 | -74.66 |
| 1.7E+09 | 0.25 | -86.92 | 3.27 | 98.79 | 7.13E-02 | 15.41 | 0.38 | -75.90 |
| 1.8E+09 | 0.24 | -88.57 | 3.10 | 97.43 | 7.17E-02 | 14.43 | 0.37 | -77.05 |
| 1.9E+09 | 0.23 | -90.12 | 2.94 | 96.15 | 7.19E-02 | 13.54 | 0.36 | -78.12 |
| 2.0E+09 | 0.22 | -91.59 | 2.80 | 94.95 | 7.21E-02 | 12.73 | 0.35 | -79.13 |
| 2.1E+09 | 0.21 | -92.98 | 2.68 | 93.81 | 7.23E-02 | 11.98 | 0.35 | -80.09 |
| 2.2E+09 | 0.20 | -94.30 | 2.56 | 92.73 | 7.25E-02 | 11.29 | 0.34 | -80.99 |
| 2.3E+09 | 0.20 | -95.57 | 2.45 | 91.70 | 7.27E-02 | 10.64 | 0.34 | -81.85 |
| 2.4E+09 | 0.19 | -96.78 | 2.35 | 90.72 | 7.28E-02 | 10.05 | 0.33 | -82.68 |
| 2.5E+09 | 0.18 | -97.93 | 2.26 | 89.78 | 7.29E-02 | 9.49 | 0.33 | -83.47 |
| 2.6E+09 | 0.18 | -99.05 | 2.18 | 88.87 | 7.30E-02 | 8.96 | 0.33 | -84.23 |
| 2.7E+09 | 0.17 | -100.12 | 2.10 | 88.00 | 7.31E-02 | 8.47 | 0.33 | -84.97 |
| 2.8E+09 | 0.17 | -101.15 | 2.02 | 87.15 | 7.31E-02 | 8.01 | 0.33 | -85.68 |
| 2.9E+09 | 0.16 | -102.15 | 1.96 | 86.33 | 7.32E-02 | 7.57 | 0.33 | -86.37 |
| 3.0E+09 | 0.16 | -103.11 | 1.89 | 85.54 | 7.32E-02 | 7.16 | 0.33 | -87.05 |

Common Emitter S-Parameters of NPN 3 μ m x 50 μ m Transistor (Continued)

| FREQ. (Hz) | S ₁₁ | PHASE(S ₁₁) | S ₂₁ | PHASE(S ₂₁) | S ₁₂ | PHASE(S ₁₂) | S ₂₂ | PHASE(S ₂₂) |
|---|-----------------|-------------------------|-----------------|-------------------------|-----------------|-------------------------|-----------------|-------------------------|
| V_{CE} = 5V and I_C = 10mA | | | | | | | | |
| 1.0E+08 | 0.72 | -16.43 | 15.12 | 165.22 | 1.27E-02 | 75.41 | 0.95 | -14.26 |
| 2.0E+08 | 0.67 | -31.26 | 13.90 | 152.04 | 2.34E-02 | 62.89 | 0.88 | -26.95 |
| 3.0E+08 | 0.60 | -43.76 | 12.39 | 141.18 | 3.13E-02 | 52.58 | 0.79 | -37.31 |
| 4.0E+08 | 0.53 | -54.00 | 10.92 | 132.57 | 3.68E-02 | 44.50 | 0.70 | -45.45 |
| 5.0E+08 | 0.47 | -62.38 | 9.62 | 125.78 | 4.05E-02 | 38.23 | 0.63 | -51.77 |
| 6.0E+08 | 0.42 | -69.35 | 8.53 | 120.37 | 4.31E-02 | 33.34 | 0.57 | -56.72 |
| 7.0E+08 | 0.37 | -75.26 | 7.62 | 116.00 | 4.49E-02 | 29.47 | 0.51 | -60.65 |
| 8.0E+08 | 0.34 | -80.36 | 6.86 | 112.39 | 4.63E-02 | 26.37 | 0.47 | -63.85 |
| 9.0E+08 | 0.31 | -84.84 | 6.22 | 109.36 | 4.72E-02 | 23.84 | 0.44 | -66.49 |
| 1.0E+09 | 0.29 | -88.83 | 5.69 | 106.77 | 4.80E-02 | 21.75 | 0.41 | -68.71 |
| 1.1E+09 | 0.27 | -92.44 | 5.23 | 104.51 | 4.86E-02 | 20.00 | 0.39 | -70.62 |
| 1.2E+09 | 0.25 | -95.73 | 4.83 | 102.53 | 4.90E-02 | 18.52 | 0.37 | -72.28 |
| 1.3E+09 | 0.24 | -98.75 | 4.49 | 100.75 | 4.94E-02 | 17.25 | 0.35 | -73.76 |
| 1.4E+09 | 0.22 | -101.55 | 4.19 | 99.16 | 4.97E-02 | 16.15 | 0.34 | -75.08 |
| 1.5E+09 | 0.21 | -104.15 | 3.93 | 97.70 | 4.99E-02 | 15.19 | 0.33 | -76.28 |
| 1.6E+09 | 0.20 | -106.57 | 3.70 | 96.36 | 5.01E-02 | 14.34 | 0.32 | -77.38 |
| 1.7E+09 | 0.20 | -108.85 | 3.49 | 95.12 | 5.03E-02 | 13.60 | 0.31 | -78.41 |
| 1.8E+09 | 0.19 | -110.98 | 3.30 | 93.96 | 5.05E-02 | 12.94 | 0.31 | -79.37 |
| 1.9E+09 | 0.18 | -113.00 | 3.13 | 92.87 | 5.06E-02 | 12.34 | 0.30 | -80.27 |
| 2.0E+09 | 0.18 | -114.90 | 2.98 | 91.85 | 5.07E-02 | 11.81 | 0.30 | -81.13 |
| 2.1E+09 | 0.17 | -116.69 | 2.84 | 90.87 | 5.08E-02 | 11.33 | 0.30 | -81.95 |
| 2.2E+09 | 0.17 | -118.39 | 2.72 | 89.94 | 5.09E-02 | 10.89 | 0.29 | -82.74 |
| 2.3E+09 | 0.16 | -120.01 | 2.60 | 89.06 | 5.10E-02 | 10.50 | 0.29 | -83.50 |
| 2.4E+09 | 0.16 | -121.54 | 2.49 | 88.21 | 5.11E-02 | 10.13 | 0.29 | -84.24 |
| 2.5E+09 | 0.16 | -122.99 | 2.39 | 87.39 | 5.12E-02 | 9.80 | 0.29 | -84.95 |
| 2.6E+09 | 0.15 | -124.37 | 2.30 | 86.60 | 5.12E-02 | 9.49 | 0.29 | -85.64 |
| 2.7E+09 | 0.15 | -125.69 | 2.22 | 85.83 | 5.13E-02 | 9.21 | 0.29 | -86.32 |
| 2.8E+09 | 0.15 | -126.94 | 2.14 | 85.09 | 5.13E-02 | 8.95 | 0.29 | -86.98 |
| 2.9E+09 | 0.15 | -128.14 | 2.06 | 84.36 | 5.14E-02 | 8.71 | 0.29 | -87.62 |
| 3.0E+09 | 0.14 | -129.27 | 1.99 | 83.66 | 5.15E-02 | 8.49 | 0.29 | -88.25 |

Common Emitter S-Parameters of PNP 3 μ m x 50 μ m Transistor

| FREQ. (Hz) | S ₁₁ | PHASE(S ₁₁) | S ₂₁ | PHASE(S ₂₁) | S ₁₂ | PHASE(S ₁₂) | S ₂₂ | PHASE(S ₂₂) |
|--|-----------------|-------------------------|-----------------|-------------------------|-----------------|-------------------------|-----------------|-------------------------|
| V_{CE} = -5V and I_C = -5mA | | | | | | | | |
| 1.0E+08 | 0.72 | -16.65 | 10.11 | 166.77 | 1.66E-02 | 77.18 | 0.96 | -10.76 |
| 2.0E+08 | 0.68 | -32.12 | 9.44 | 154.69 | 3.10E-02 | 65.94 | 0.90 | -20.38 |
| 3.0E+08 | 0.62 | -45.73 | 8.57 | 144.40 | 4.23E-02 | 56.39 | 0.82 | -28.25 |
| 4.0E+08 | 0.57 | -57.39 | 7.68 | 135.95 | 5.05E-02 | 48.66 | 0.74 | -34.31 |
| 5.0E+08 | 0.52 | -67.32 | 6.86 | 129.11 | 5.64E-02 | 42.52 | 0.67 | -38.81 |

HFA3046, HFA3096, HFA3127, HFA3128

Common Emitter S-Parameters of PNP 3 μm x 50 μm Transistor (Continued)

| FREQ. (Hz) | S ₁₁ | PHASE(S ₁₁) | S ₂₁ | PHASE(S ₂₁) | S ₁₂ | PHASE(S ₁₂) | S ₂₂ | PHASE(S ₂₂) |
|--|-----------------|-------------------------|-----------------|-------------------------|-----------------|-------------------------|-----------------|-------------------------|
| 6.0E+08 | 0.47 | -75.83 | 6.14 | 123.55 | 6.07E-02 | 37.66 | 0.61 | -42.10 |
| 7.0E+08 | 0.43 | -83.18 | 5.53 | 118.98 | 6.37E-02 | 33.79 | 0.55 | -44.47 |
| 8.0E+08 | 0.40 | -89.60 | 5.01 | 115.17 | 6.60E-02 | 30.67 | 0.51 | -46.15 |
| 9.0E+08 | 0.38 | -95.26 | 4.56 | 111.94 | 6.77E-02 | 28.14 | 0.47 | -47.33 |
| 1.0E+09 | 0.36 | -100.29 | 4.18 | 109.17 | 6.91E-02 | 26.06 | 0.44 | -48.15 |
| 1.1E+09 | 0.34 | -104.80 | 3.86 | 106.76 | 7.01E-02 | 24.33 | 0.41 | -48.69 |
| 1.2E+09 | 0.33 | -108.86 | 3.58 | 104.63 | 7.09E-02 | 22.89 | 0.39 | -49.05 |
| 1.3E+09 | 0.32 | -112.53 | 3.33 | 102.72 | 7.16E-02 | 21.67 | 0.37 | -49.26 |
| 1.4E+09 | 0.30 | -115.86 | 3.12 | 101.01 | 7.22E-02 | 20.64 | 0.36 | -49.38 |
| 1.5E+09 | 0.30 | -118.90 | 2.92 | 99.44 | 7.27E-02 | 19.76 | 0.34 | -49.43 |
| 1.6E+09 | 0.29 | -121.69 | 2.75 | 98.01 | 7.32E-02 | 19.00 | 0.33 | -49.44 |
| 1.7E+09 | 0.28 | -124.24 | 2.60 | 96.68 | 7.35E-02 | 18.35 | 0.32 | -49.43 |
| 1.8E+09 | 0.28 | -126.59 | 2.47 | 95.44 | 7.39E-02 | 17.79 | 0.31 | -49.40 |
| 1.9E+09 | 0.27 | -128.76 | 2.34 | 94.29 | 7.42E-02 | 17.30 | 0.30 | -49.38 |
| 2.0E+09 | 0.27 | -130.77 | 2.23 | 93.19 | 7.45E-02 | 16.88 | 0.30 | -49.36 |
| 2.1E+09 | 0.26 | -132.63 | 2.13 | 92.16 | 7.47E-02 | 16.52 | 0.29 | -49.35 |
| 2.2E+09 | 0.26 | -134.35 | 2.04 | 91.18 | 7.50E-02 | 16.20 | 0.28 | -49.35 |
| 2.3E+09 | 0.26 | -135.96 | 1.95 | 90.24 | 7.52E-02 | 15.92 | 0.28 | -49.38 |
| 2.4E+09 | 0.25 | -137.46 | 1.87 | 89.34 | 7.55E-02 | 15.68 | 0.28 | -49.42 |
| 2.5E+09 | 0.25 | -138.86 | 1.80 | 88.48 | 7.57E-02 | 15.48 | 0.27 | -49.49 |
| 2.6E+09 | 0.25 | -140.17 | 1.73 | 87.65 | 7.59E-02 | 15.30 | 0.27 | -49.56 |
| 2.7E+09 | 0.25 | -141.39 | 1.67 | 86.85 | 7.61E-02 | 15.15 | 0.26 | -49.67 |
| 2.8E+09 | 0.25 | -142.54 | 1.61 | 86.07 | 7.63E-02 | 15.01 | 0.26 | -49.81 |
| 2.9E+09 | 0.24 | -143.62 | 1.56 | 85.31 | 7.65E-02 | 14.90 | 0.26 | -49.96 |
| 3.0E+09 | 0.24 | -144.64 | 1.51 | 84.58 | 7.67E-02 | 14.81 | 0.26 | -50.13 |
| V_{CE} = -5V, I_C = -10mA | | | | | | | | |
| 1.0E+08 | 0.58 | -23.24 | 13.03 | 163.45 | 1.43E-02 | 73.38 | 0.93 | -13.46 |
| 2.0E+08 | 0.53 | -44.07 | 11.75 | 149.11 | 2.58E-02 | 60.43 | 0.85 | -24.76 |
| 3.0E+08 | 0.48 | -61.50 | 10.25 | 137.78 | 3.38E-02 | 50.16 | 0.74 | -33.10 |
| 4.0E+08 | 0.43 | -75.73 | 8.88 | 129.12 | 3.90E-02 | 42.49 | 0.65 | -38.83 |
| 5.0E+08 | 0.40 | -87.36 | 7.72 | 122.49 | 4.25E-02 | 36.81 | 0.58 | -42.63 |
| 6.0E+08 | 0.37 | -96.94 | 6.78 | 117.33 | 4.48E-02 | 32.59 | 0.51 | -45.07 |
| 7.0E+08 | 0.35 | -104.92 | 6.01 | 113.22 | 4.64E-02 | 29.39 | 0.47 | -46.60 |
| 8.0E+08 | 0.33 | -111.64 | 5.39 | 109.85 | 4.76E-02 | 26.94 | 0.43 | -47.49 |
| 9.0E+08 | 0.32 | -117.36 | 4.87 | 107.05 | 4.85E-02 | 25.04 | 0.40 | -47.97 |
| 1.0E+09 | 0.31 | -122.27 | 4.44 | 104.66 | 4.92E-02 | 23.55 | 0.37 | -48.18 |
| 1.1E+09 | 0.30 | -126.51 | 4.07 | 102.59 | 4.97E-02 | 22.37 | 0.35 | -48.20 |
| 1.2E+09 | 0.30 | -130.21 | 3.76 | 100.76 | 5.02E-02 | 21.44 | 0.33 | -48.11 |

Common Emitter S-Parameters of PNP 3 μm x 50 μm Transistor (Continued)

| FREQ. (Hz) | S ₁₁ | PHASE(S ₁₁) | S ₂₁ | PHASE(S ₂₁) | S ₁₂ | PHASE(S ₁₂) | S ₂₂ | PHASE(S ₂₂) |
|------------|-----------------|-------------------------|-----------------|-------------------------|-----------------|-------------------------|-----------------|-------------------------|
| 1.3E+09 | 0.29 | -133.46 | 3.49 | 99.14 | 5.06E-02 | 20.70 | 0.32 | -47.95 |
| 1.4E+09 | 0.29 | -136.33 | 3.25 | 97.67 | 5.09E-02 | 20.11 | 0.31 | -47.77 |
| 1.5E+09 | 0.28 | -138.89 | 3.05 | 96.33 | 5.12E-02 | 19.65 | 0.30 | -47.58 |
| 1.6E+09 | 0.28 | -141.17 | 2.87 | 95.10 | 5.15E-02 | 19.29 | 0.29 | -47.39 |
| 1.7E+09 | 0.28 | -143.21 | 2.70 | 93.96 | 5.18E-02 | 19.01 | 0.28 | -47.23 |
| 1.8E+09 | 0.28 | -145.06 | 2.56 | 92.90 | 5.21E-02 | 18.80 | 0.27 | -47.09 |
| 1.9E+09 | 0.27 | -146.73 | 2.43 | 91.90 | 5.23E-02 | 18.65 | 0.27 | -46.98 |
| 2.0E+09 | 0.27 | -148.26 | 2.31 | 90.95 | 5.26E-02 | 18.55 | 0.26 | -46.91 |
| 2.1E+09 | 0.27 | -149.65 | 2.20 | 90.05 | 5.28E-02 | 18.49 | 0.26 | -46.87 |
| 2.2E+09 | 0.27 | -150.92 | 2.10 | 89.20 | 5.30E-02 | 18.46 | 0.25 | -46.87 |
| 2.3E+09 | 0.27 | -152.10 | 2.01 | 88.37 | 5.33E-02 | 18.47 | 0.25 | -46.90 |
| 2.4E+09 | 0.27 | -153.18 | 1.93 | 87.59 | 5.35E-02 | 18.50 | 0.25 | -46.97 |
| 2.5E+09 | 0.27 | -154.17 | 1.86 | 86.82 | 5.38E-02 | 18.55 | 0.24 | -47.07 |
| 2.6E+09 | 0.26 | -155.10 | 1.79 | 86.09 | 5.40E-02 | 18.62 | 0.24 | -47.18 |
| 2.7E+09 | 0.26 | -155.96 | 1.72 | 85.38 | 5.42E-02 | 18.71 | 0.24 | -47.34 |
| 2.8E+09 | 0.26 | -156.76 | 1.66 | 84.68 | 5.45E-02 | 18.80 | 0.24 | -47.55 |
| 2.9E+09 | 0.26 | -157.51 | 1.60 | 84.01 | 5.47E-02 | 18.91 | 0.24 | -47.76 |
| 3.0E+09 | 0.26 | -158.21 | 1.55 | 83.35 | 5.50E-02 | 19.03 | 0.23 | -48.00 |

Typical Performance Curves

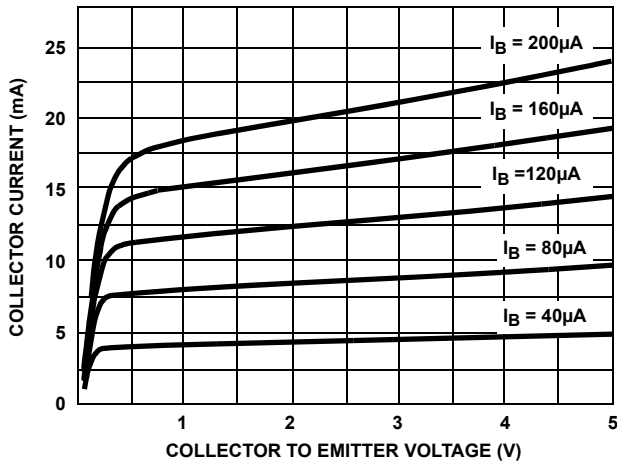

FIGURE 1. NPN COLLECTOR CURRENT vs COLLECTOR TO EMITTER VOLTAGE

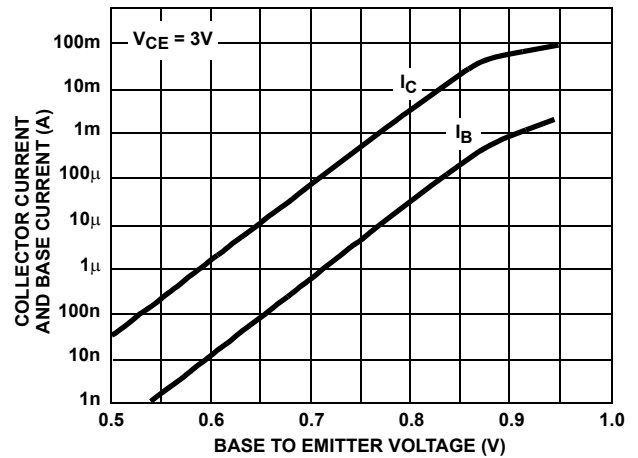

FIGURE 2. NPN COLLECTOR CURRENT AND BASE CURRENT vs BASE TO EMITTER VOLTAGE

Typical Performance Curves (Continued)

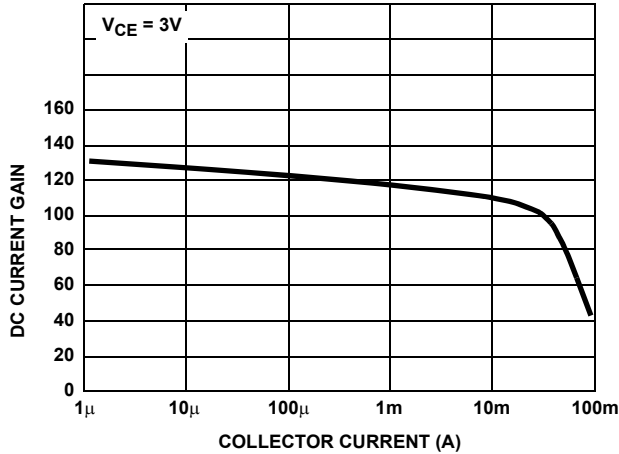

FIGURE 3. NPN DC CURRENT GAIN vs COLLECTOR CURRENT

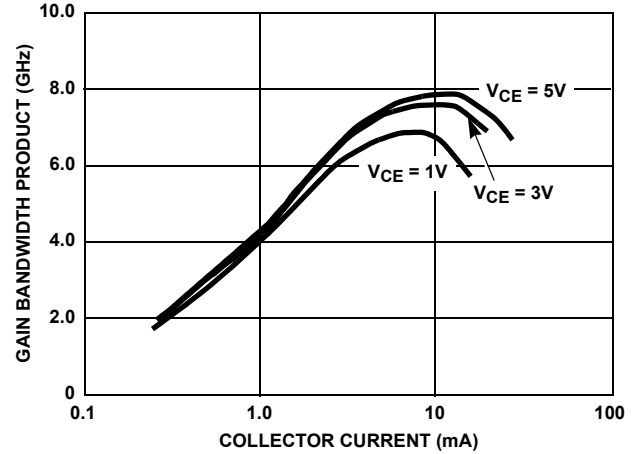

FIGURE 4. NPN GAIN BANDWIDTH PRODUCT vs COLLECTOR CURRENT (UHF 3 x 50 WITH BOND PADS)

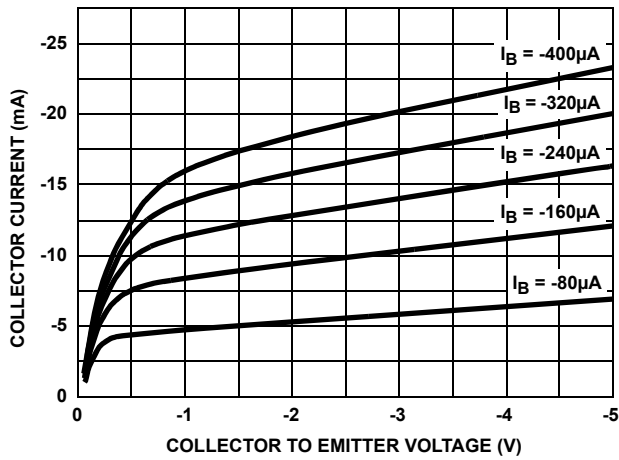

FIGURE 5. PNP COLLECTOR CURRENT vs COLLECTOR TO EMITTER VOLTAGE

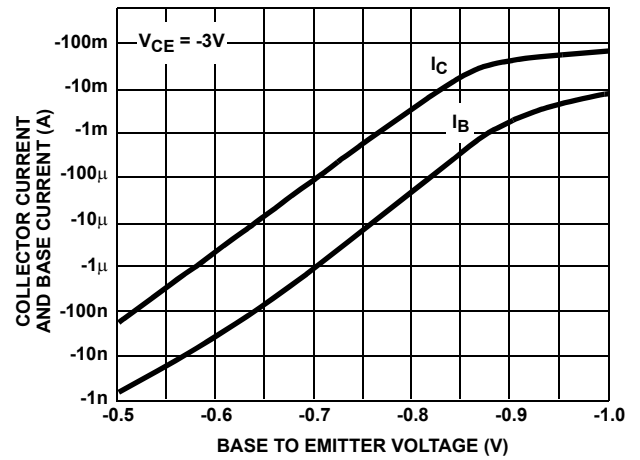

FIGURE 6. PNP COLLECTOR CURRENT AND BASE CURRENT vs BASE TO EMITTER VOLTAGE

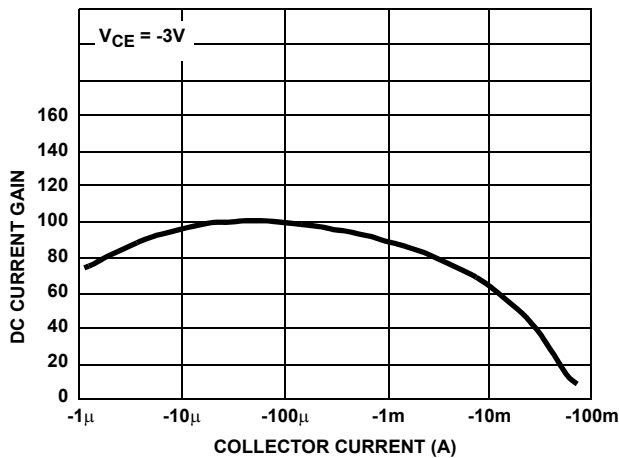

FIGURE 7. PNP DC CURRENT GAIN vs COLLECTOR CURRENT

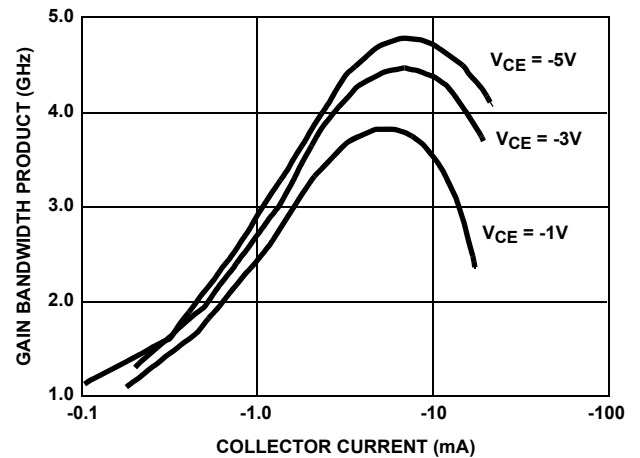

FIGURE 8. PNP GAIN BANDWIDTH PRODUCT vs COLLECTOR CURRENT (UHF 3 x 50 WITH BOND PADS)

Die Characteristics

DIE DIMENSIONS:

53 mils x 52 mils
 1340µm x 1320µm

METALLIZATION:

Type: Metal 1: AlCu(2%)/TiW
 Thickness: Metal 1: 8kÅ ±0.4kÅ
 Type: Metal 2: AlCu(2%)
 Thickness: Metal 2: 16kÅ ±0.8kÅ

PASSIVATION:

Type: Nitride
 Thickness: 4kÅ ±0.5kÅ

PROCESS:

UHF-1

SUBSTRATE POTENTIAL: (POWERED UP)

Unbiased

Metallization Mask Layout

HFA3096, HFA3127, HFA3128

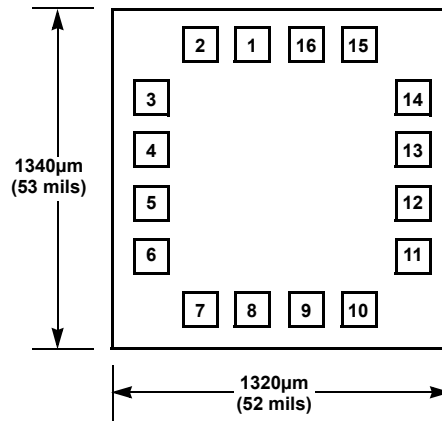

HFA3046

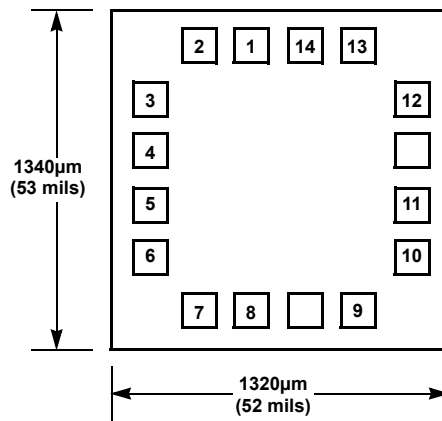

Pad numbers correspond to SOIC pinout.

Revision History

The revision history provided is for informational purposes only and is believed to be accurate, but not warranted. Please go to the web to make sure that you have the latest revision.

| DATE | REVISION | CHANGE |
|-----------------|-----------|--|
| August 11, 2015 | FN3076.15 | Added Revision History beginning with Rev 15. Updated ordering information table with "No longer available or supported" next to HFA3128 part numbers |

About Intersil

Intersil Corporation is a leading provider of innovative power management and precision analog solutions. The company's products address some of the largest markets within the industrial and infrastructure, mobile computing and high-end consumer markets.

For the most updated datasheet, application notes, related documentation and related parts, please see the respective product information page found at www.intersil.com.

You may report errors or suggestions for improving this datasheet by visiting www.intersil.com/ask.

Reliability reports are also available from our website at www.intersil.com/support

For additional products, see www.intersil.com/en/products.html

Intersil products are manufactured, assembled and tested utilizing ISO9001 quality systems as noted in the quality certifications found at www.intersil.com/en/support/qualandreliability.html

Intersil products are sold by description only. Intersil Corporation reserves the right to make changes in circuit design, software and/or specifications at any time without notice. Accordingly, the reader is cautioned to verify that data sheets are current before placing orders. Information furnished by Intersil is believed to be accurate and reliable. However, no responsibility is assumed by Intersil or its subsidiaries for its use; nor for any infringements of patents or other rights of third parties which may result from its use. No license is granted by implication or otherwise under any patent or patent rights of Intersil or its subsidiaries.

For information regarding Intersil Corporation and its products, see www.intersil.com

Package Outline Drawing

M14.15

14 LEAD NARROW BODY SMALL OUTLINE PLASTIC PACKAGE

Rev 1, 10/09

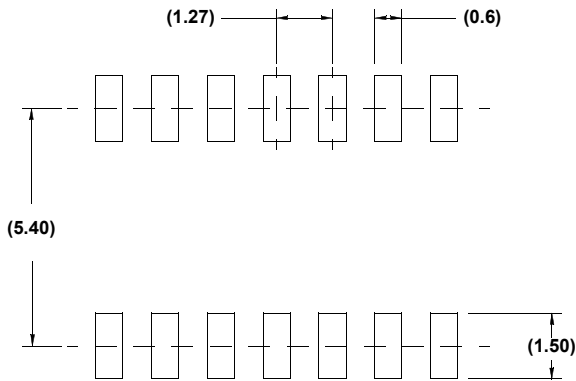
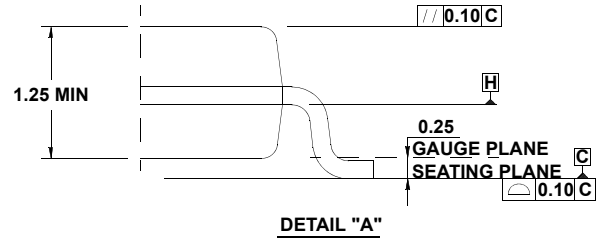
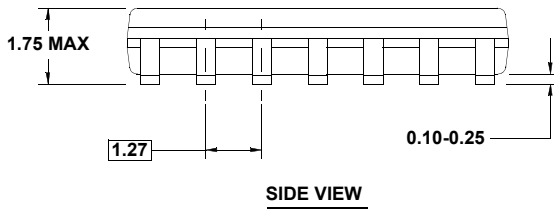
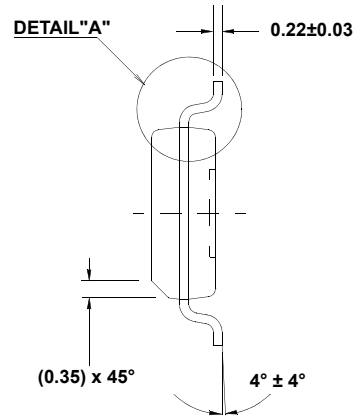
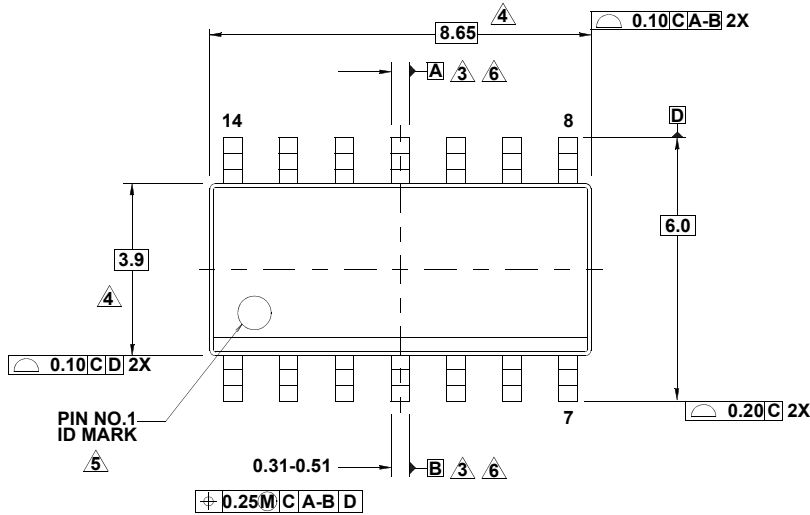

NOTES:

1. Dimensions are in millimeters.
Dimensions in () for Reference Only.
2. Dimensioning and tolerancing conform to AMSEY14.5m-1994.
3. Datums A and B to be determined at Datum H.
4. Dimension does not include interlead flash or protrusions.
Interlead flash or protrusions shall not exceed 0.25mm per side.
5. The pin #1 identifier may be either a mold or mark feature.
6. Does not include dambar protrusion. Allowable dambar protrusion shall be 0.10mm total in excess of lead width at maximum condition.
7. Reference to JEDEC MS-012-AB.

Small Outline Plastic Packages (SOIC)

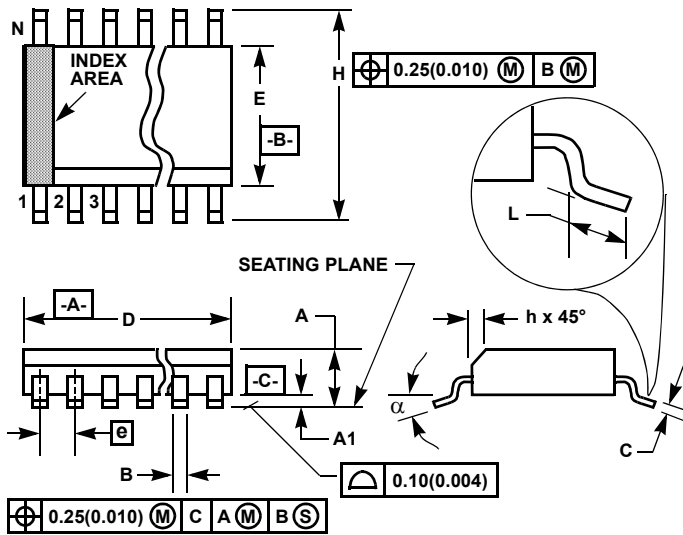

M16.15 (JEDEC MS-012-AC ISSUE C)
16 LEAD NARROW BODY SMALL OUTLINE PLASTIC PACKAGE

| SYMBOL | INCHES | | MILLIMETERS | | NOTES |
|----------|-----------|--------|-------------|-------|-------|
| | MIN | MAX | MIN | MAX | |
| A | 0.0532 | 0.0688 | 1.35 | 1.75 | - |
| A1 | 0.0040 | 0.0098 | 0.10 | 0.25 | - |
| B | 0.013 | 0.020 | 0.33 | 0.51 | 9 |
| C | 0.0075 | 0.0098 | 0.19 | 0.25 | - |
| D | 0.3859 | 0.3937 | 9.80 | 10.00 | 3 |
| E | 0.1497 | 0.1574 | 3.80 | 4.00 | 4 |
| e | 0.050 BSC | | 1.27 BSC | | - |
| H | 0.2284 | 0.2440 | 5.80 | 6.20 | - |
| h | 0.0099 | 0.0196 | 0.25 | 0.50 | 5 |
| L | 0.016 | 0.050 | 0.40 | 1.27 | 6 |
| N | 16 | | 16 | | 7 |
| α | 0° | 8° | 0° | 8° | - |

NOTES:

1. Symbols are defined in the "MO Series Symbol List" in Section 2.2 of Publication Number 95.
2. Dimensioning and tolerancing per ANSI Y14.5M-1982.
3. Dimension "D" does not include mold flash, protrusions or gate burrs. Mold flash, protrusion and gate burrs shall not exceed 0.15mm (0.006 inch) per side.
4. Dimension "E" does not include interlead flash or protrusions. Interlead flash and protrusions shall not exceed 0.25mm (0.010 inch) per side.
5. The chamfer on the body is optional. If it is not present, a visual index feature must be located within the crosshatched area.
6. "L" is the length of terminal for soldering to a substrate.
7. "N" is the number of terminal positions.
8. Terminal numbers are shown for reference only.
9. The lead width "B", as measured 0.36mm (0.014 inch) or greater above the seating plane, shall not exceed a maximum value of 0.61mm (0.024 inch).
10. Controlling dimension: MILLIMETER. Converted inch dimensions are not necessarily exact.

Rev. 1 6/05

Package Outline Drawing

L16.3x3

16 LEAD QUAD FLAT NO-LEAD PLASTIC PACKAGE

Rev 2, 4/07

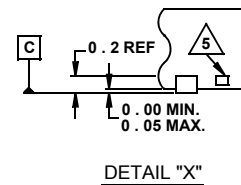
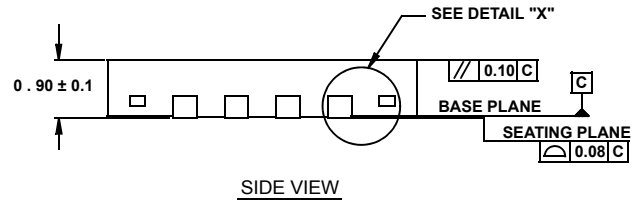
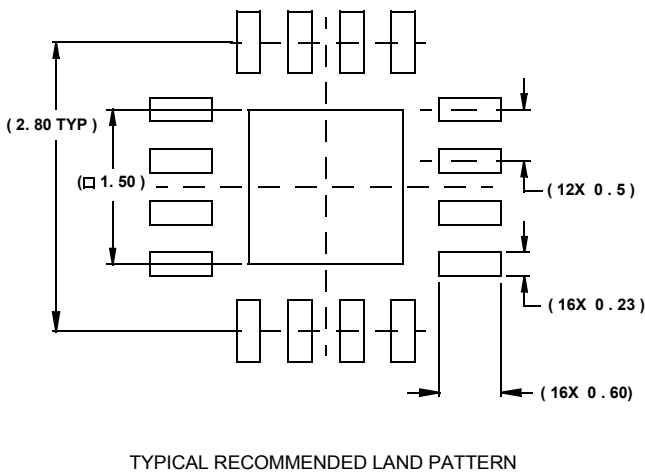
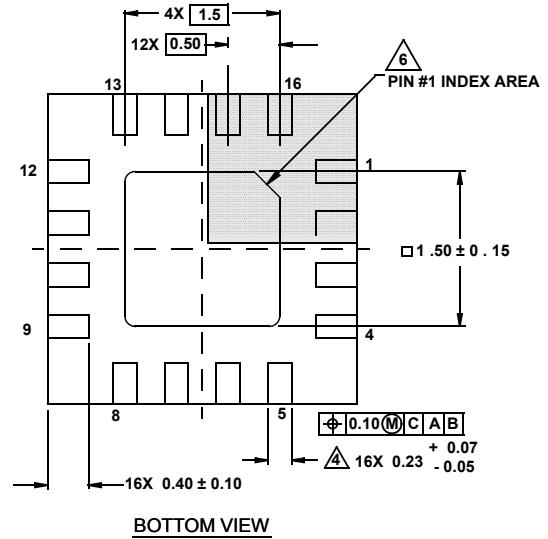
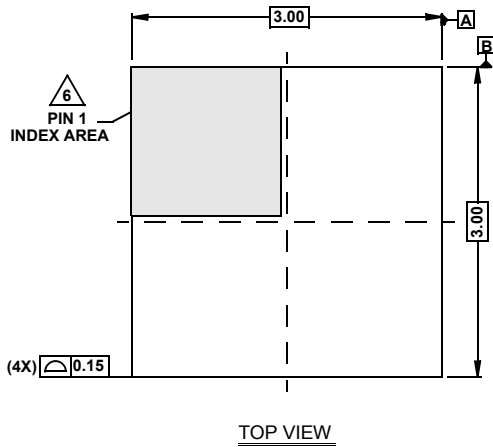

NOTES:

1. Dimensions are in millimeters.
Dimensions in () for Reference Only.
2. Dimensioning and tolerancing conform to AMSE Y14.5m-1994.
3. Unless otherwise specified, tolerance : Decimal ± 0.05
4. Dimension b applies to the metallized terminal and is measured between 0.15mm and 0.30mm from the terminal tip.
5. Tiebar shown (if present) is a non-functional feature.
6. The configuration of the pin #1 identifier is optional, but must be located within the zone indicated. The pin #1 identifier may be either a mold or mark feature.