



Chipsmall Limited consists of a professional team with an average of over 10 year of expertise in the distribution of electronic components. Based in Hongkong, we have already established firm and mutual-benefit business relationships with customers from,Europe,America and south Asia,supplying obsolete and hard-to-find components to meet their specific needs.

With the principle of "Quality Parts,Customers Priority,Honest Operation,and Considerate Service",our business mainly focus on the distribution of electronic components. Line cards we deal with include Microchip,ALPS,ROHM,Xilinx,Pulse,ON,Everlight and Freescale. Main products comprise IC,Modules,Potentiometer,IC Socket,Relay,Connector.Our parts cover such applications as commercial,industrial, and automotives areas.

We are looking forward to setting up business relationship with you and hope to provide you with the best service and solution. Let us make a better world for our industry!



Contact us

Tel: +86-755-8981 8866 Fax: +86-755-8427 6832

Email & Skype: info@chipsmall.com Web: www.chipsmall.com

Address: A1208, Overseas Decoration Building, #122 Zhenhua RD., Futian, Shenzhen, China



HIGH FREQUENCY BALUN ADAPTOR For SMPTE-292M HDTV

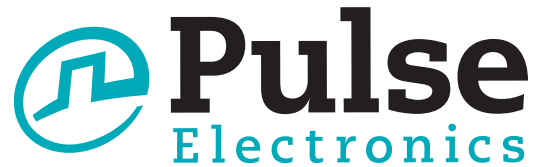

- Transforms 100Ω balanced differential signal to 75Ω , Grounded unbalanced signal
- Designed for SMPTE-292M HDTV application at 1.485GBs data rate
- Operating Temperature:** -55°C to +125°C
- Designed for flight application with super Environmental , EMI and corrosion protection

Characteristics

Part Number	Impedance Unbalanced	Impedance Balanced	Insertion Loss db MAX. 1.485 GBs	Jitter Dj pSec. Max. 1.485 GBs, PN7
HFB075100A	75	100	-2.0	110.0
HFB075100B	75	100	-2.0	110.0

Mechanical

Schematic

HFB075100A

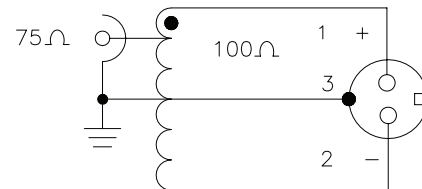
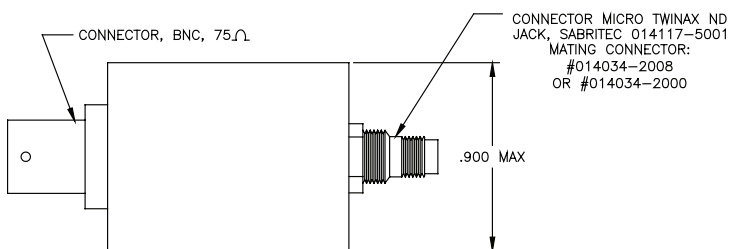
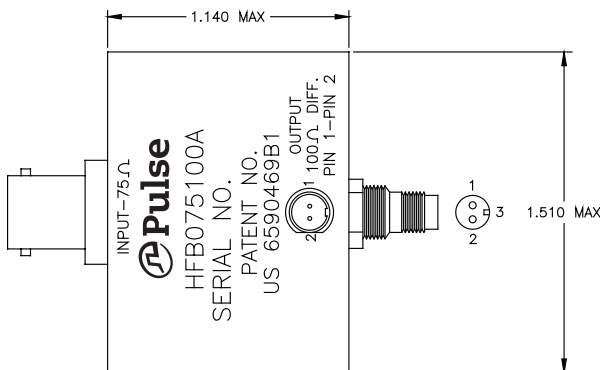

HIGH FREQUENCY BALUN ADAPTOR For SMPTE-292M HDTV

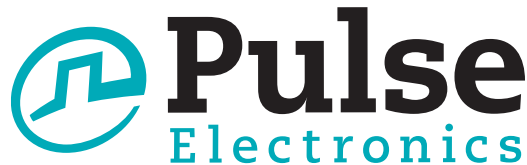

Mechanical

Schematic

HFB075100B

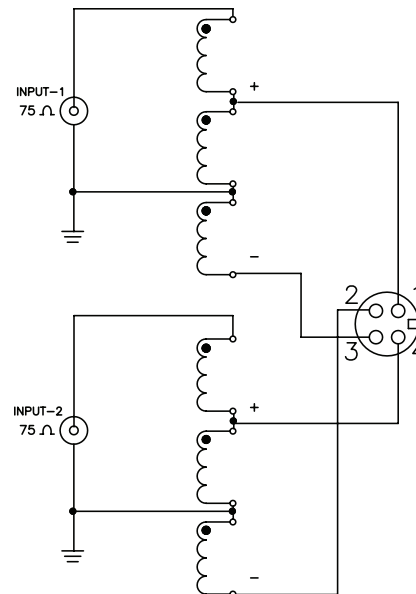
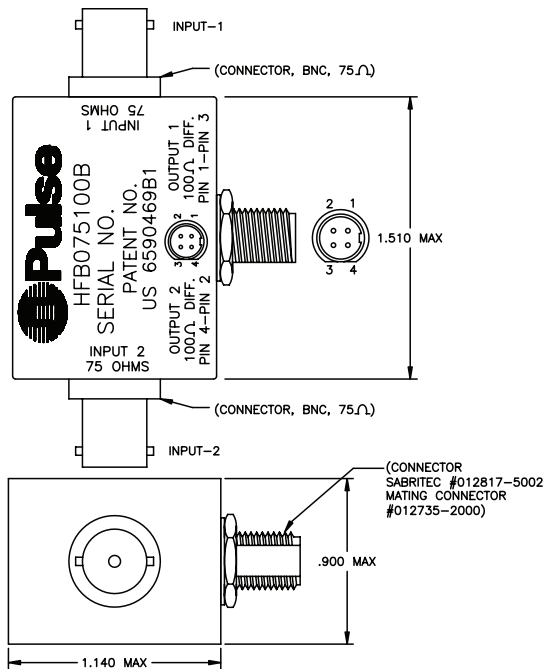

For More Information

Pulse Worldwide Headquarters
12220 World Trade Drive
San Diego, CA 92128
U.S.A.

Pulse Europe
Zeppelinstrasse 15
71083 Herrenberg
Germany

Pulse China Headquarters
B402, Shenzhen Academy of
Aerospace Technology Bldg.
10th Kejinan Road
High-Tech Zone
Nanshan District
Shenzhen, PR China 518057
Tel: 86 755 33966678
Fax: 86 755 33966700

Pulse North China
Room 2704/2705
Super Ocean Finance Ctr.
2067 Yan An Road West
Shanghai 200336
China

Pulse South Asia
135 Joo Seng Road
#03-02
PM Industrial Bldg.
Singapore 368363

Pulse North Asia
3F No. 198, Zhongyuan Road
Zhongli City
Taoyuan County (32068)
Taiwan

Tel: 858 674 8100
Fax: 858 674 8262

Tel: 49 7032 7806 0
Fax: 49 7032 7806 12

Tel: 86 21 62787060
Fax: 86 2162786973

Tel: 65 6287 8998
Fax: 65 6287 8998

Tel: 886 3 4356768
Fax: 886 3 4356823

Performance warranty of products offered on this data sheet is limited to the parameters specified. Data is subject to change without notice. Other brand and product names mentioned herein may be trademarks or registered trademarks of their respective owners. © Copyright, 2013. Pulse Electronics, Inc. All rights reserved.