



Chipsmall Limited consists of a professional team with an average of over 10 year of expertise in the distribution of electronic components. Based in Hongkong, we have already established firm and mutual-benefit business relationships with customers from,Europe,America and south Asia,supplying obsolete and hard-to-find components to meet their specific needs.

With the principle of “Quality Parts,Customers Priority,Honest Operation,and Considerate Service”,our business mainly focus on the distribution of electronic components. Line cards we deal with include Microchip,ALPS,ROHM,Xilinx,Pulse,ON,Everlight and Freescale. Main products comprise IC,Modules,Potentiometer,IC Socket,Relay,Connector.Our parts cover such applications as commercial,industrial, and automotives areas.

We are looking forward to setting up business relationship with you and hope to provide you with the best service and solution. Let us make a better world for our industry!



Contact us

Tel: +86-755-8981 8866 Fax: +86-755-8427 6832

Email & Skype: info@chipsmall.com Web: www.chipsmall.com

Address: A1208, Overseas Decoration Building, #122 Zhenhua RD., Futian, Shenzhen, China



HLMP-Cxxx

T-13/4 (5 mm) Precision Optical Performance
InGaN Blue, Green and Cyan Lamps



Data Sheet

HLMP-CB15, HLMP-CB16, HLMP-CB30, HLMP-CB31, HLMP-CM15, HLMP-CM16, HLMP-CM30,
HLMP-CM31, HLMP-CE15, HLMP-CE16, HLMP-CE23, HLMP-CE24, HLMP-CE30, HLMP-CE31

Description

These high intensity blue, green and cyan LEDs are based on InGaN material technology. InGaN is the most efficient and cost effective material for LEDs in the blue and green region of the spectrum. The 472 nm typical dominant wavelength for blue and 526 nm typical dominant wavelength for green are well suited to color mixing in full color signs. The 505 nm typical dominant wavelength matches international specifications for green traffic signals. These LED lamps are untinted, nondiffused, T-13/4 packages incorporating second generation optics which produce well defined spatial radiation patterns at specific viewing cone angles. These lamps are made with an advanced optical grade epoxy, offering superior high temperature and high moisture resistance performance in outdoor signal and sign applications. The high maximum LED junction temperature limit of +130°C enables high temperature operation in bright sunlight conditions. The package epoxy contains both UV-A and UV-B inhibitors to reduce the effects of long term exposure to direct sunlight. These lamps are available in two viewing angle for Green and Blue, and 3 viewing angles options for Cyan to give the designer flexibility with optical design.

Features

- Well defined spatial radiation pattern
- Viewing angles: 15°, 23° and 30°
- High luminous output
- Colors: 472 nm Blue, 526 nm Green, 505 nm Cyan
- Superior resistance to moisture
- UV resistant epoxy

Benefits

- Superior performance in outdoor environments
- Wavelengths suitable for color mixing in full color (RGB) signs

Applications

- Commercial outdoor signs
- Automotive interior lights
- Front panel indicators
- Front panel backlighting

CAUTION: HLMP-CBxx, HLMP-CMxx and HLMP-CExx LEDs are Class 1C ESD sensitive. Please observe appropriate precautions during handling and processing. Refer to Avago Application Note AN-1142 for additional details.

Device Selection Guide

Part Number	Typical Viewing Angle $2\theta_{1/2}$ (Deg) ^[1]	Color and Typ. Dominant Wavelength λ_d (nm) ^[2]	Luminous Intensity, I_v (mcd) at 20 mA ^[3,4,5]		Leads with Stand-Offs	Package Drawing
			Min.	Max.		
HLMP-CB15-P00xx	15°	Blue 472	880	-	No	A
HLMP-CB15-QT0xx	15°	Blue 472	1150	3200	No	A
HLMP-CB15-R00xx	15°	Blue 472	1500	-	No	A
HLMP-CB15-RSCxx	15°	Blue 472	1500	2500	No	A
HLMP-CB16-P00xx	15°	Blue 472	880	-	Yes	B
HLMP-CB16-QT0xx	15°	Blue 472	1150	3200	Yes	B
HLMP-CM15-S00xx	15°	Green 526	1900	-	No	A
HLMP-CM15-SV0xx	15°	Green 526	1900	5500	No	A
HLMP-CM15-VY0xx	15°	Green 526	4200	12000	No	A
HLMP-CM15-W00xx	15°	Green 526	5500	-	No	A
HLMP-CM15-WXBxx	15°	Green 526	5500	9300	No	A
HLMP-CM15-WZ0xx	15°	Green 526	5500	16000	No	A
HLMP-CM16-S00xx	15°	Green 526	1900	-	Yes	B
HLMP-CM16-VY0xx	15°	Green 526	4200	12000	Yes	B
HLMP-CM16-WYGxx	15°	Green 526	5500	12000	Yes	B
HLMP-CE15-VWCxx	15°	Cyan 505	4200	7200	No	A
HLMP-CE15-WZCxx	15°	Cyan 505	5500	16000	No	A
HLMP-CE15-WZQxx	15°	Cyan 505	5500	16000	No	A
HLMP-CE16-UXQxx	15°	Cyan 505	3200	9300	Yes	B
HLMP-CE16-WZBxx	15°	Cyan 505	5500	16000	Yes	B
HLMP-CE16-WZCxx	15°	Cyan 505	5500	16000	Yes	B
HLMP-CE16-WZQxx	15°	Cyan 505	5500	16000	Yes	B
HLMP-CE23-UVQxx	23°	Cyan 505	3200	5500	No	A
HLMP-CE23-UXCxx	23°	Cyan 505	3200	9300	No	A
HLMP-CE23-UXQxx	23°	Cyan 505	3200	9300	No	A
HLMP-CE23-VWCxx	23°	Cyan 505	4200	7200	No	A
HLMP-CE23-VWQxx	23°	Cyan 505	4200	7200	No	A
HLMP-CE23-VXQxx	23°	Cyan 505	4200	9300	No	A
HLMP-CE23-VYCxx	23°	Cyan 505	4200	12000	No	A
HLMP-CE24-UX0xx	23°	Cyan 505	3200	9300	Yes	B
HLMP-CE24-UXCxx	23°	Cyan 505	3200	9300	Yes	B
HLMP-CE24-UXQxx	23°	Cyan 505	3200	9300	Yes	B
HLMP-CE24-VXQxx	23°	Cyan 505	4200	9300	Yes	B
HLMP-CE24-VYCxx	23°	Cyan 505	4200	12000	Yes	B
HLMP-CE24-VYQxx	23°	Cyan 505	4200	12000	Yes	B

Device Selection Guide (Continued)

Part Number	Typical Viewing Angle $2\theta_{1/2}$ (Deg) ^[1]	Color and Typ. Dominant Wavelength λ_d (nm) ^[2]	Luminous Intensity, I_v (mcd) at 20 mA ^[3,4,5]		Leads with Stand-Offs	Package Drawing
			Min.	Max.		
HLMP-CB30-K00xx	30°	Blue 472	310	-	No	A
HLMP-CB30-M00xx	30°	Blue 472	520	-	No	A
HLMP-CB30-NPCxx	30°	Blue 472	680	1150	No	A
HLMP-CB30-NRGxx	30°	Blue 472	680	1900	No	A
HLMP-CB30-PQCxx	30°	Blue 472	880	1500	No	A
HLMP-CB31-M00xx	30°	Blue 472	520	-	Yes	B
HLMP-CB31-NRGxx	30°	Blue 472	680	1900	Yes	B
HLMP-CB31-PQCxx	30°	Blue 472	880	1500	Yes	B
HLMP-CM30-M00xx	30°	Green 526	520	-	No	A
HLMP-CM30-RSBxx	30°	Green 526	1500	2500	No	A
HLMP-CM30-S00xx	30°	Green 526	1900	-	No	A
HLMP-CM30-TUCxx	30°	Green 526	2500	4200	No	A
HLMP-CM30-TW0xx	30°	Green 526	2500	7200	No	A
HLMP-CM30-TWAxx	30°	Green 526	2500	7200	No	A
HLMP-CM30-UVAxx	30°	Green 526	3200	5500	No	A
HLMP-CM30-UVCxx	30°	Green 526	3200	5500	No	A
HLMP-CM31-M00xx	30°	Green 526	520	-	Yes	B
HLMP-CM31-S00xx	30°	Green 526	1900	-	Yes	B
HLMP-CM31-S0Dxx	30°	Green 526	1900	-	Yes	B
HLMP-CM31-TUCxx	30°	Green 526	2500	4200	Yes	B
HLMP-CM31-TW0xx	30°	Green 526	2500	7200	Yes	B
HLMP-CM31-TWAxx	30°	Green 526	2500	7200	Yes	B
HLMP-CM31-UVCxx	30°	Green 526	3200	5500	Yes	B
HLMP-CM31-VWCxx	30°	Green 526	4200	7200	Yes	B
HLMP-CE30-RSCxx	30°	Cyan 505	1500	2500	No	A
HLMP-CE30-RUCxx	30°	Cyan 505	1500	4200	No	A
HLMP-CE30-STQxx	30°	Cyan 505	1900	3200	No	A
HLMP-CE30-SVCxx	30°	Cyan 505	1900	5500	No	A
HLMP-CE30-SVQxx	30°	Cyan 505	1900	5500	No	A
HLMP-CE31-SVCxx	30°	Cyan 505	1900	5500	Yes	B
HLMP-CE31-SVQxx	30°	Cyan 505	1900	5500	Yes	B

Notes:

- $\theta_{1/2}$ is the off-axis angle where the luminous intensity is one half the on-axis intensity.
- Dominant Wavelength, λ_d , is derived from the CIE Chromaticity Diagram and represents the color of the lamp.
- The luminous intensity is measured on the mechanical axis of the lamp package.
- The optical axis is closely aligned with the package mechanical axis.
- Tolerance for each intensity bin limit is $\pm 15\%$.

Part Numbering System

HLMP - X X XX - X X X XX

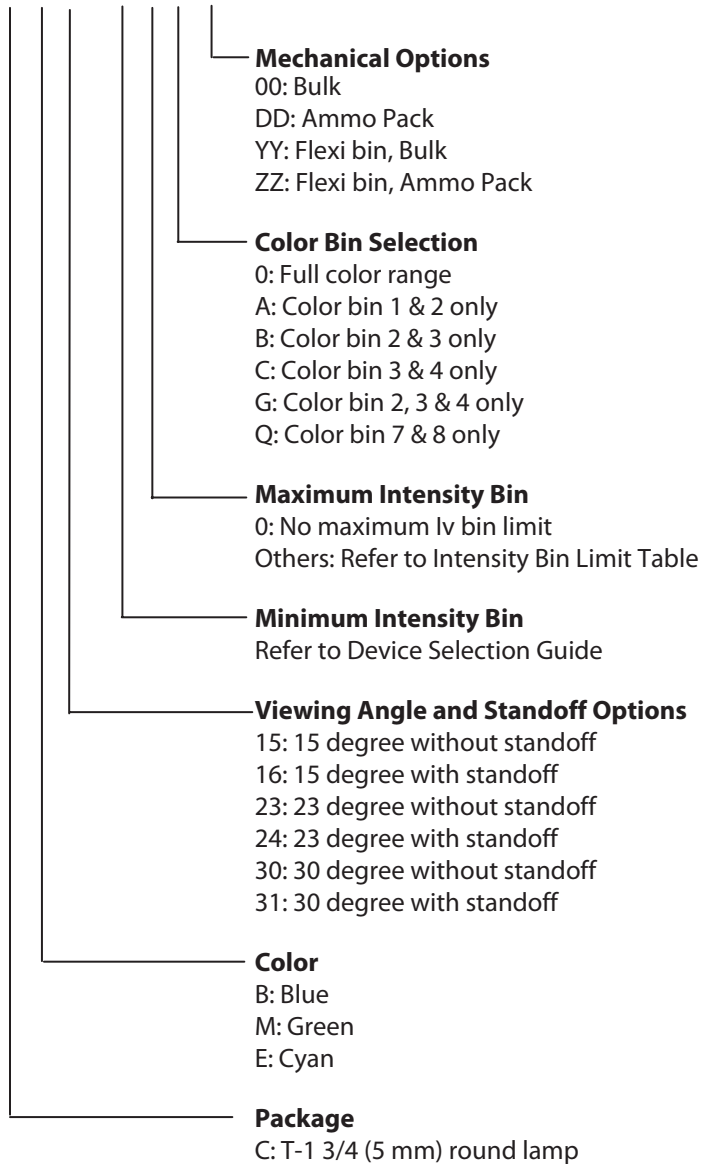

Package Dimensions

Package A

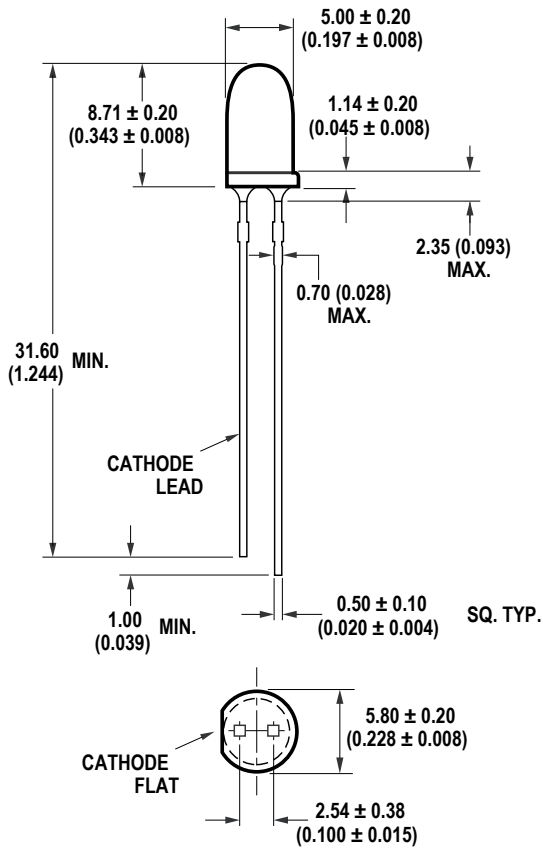

Package B

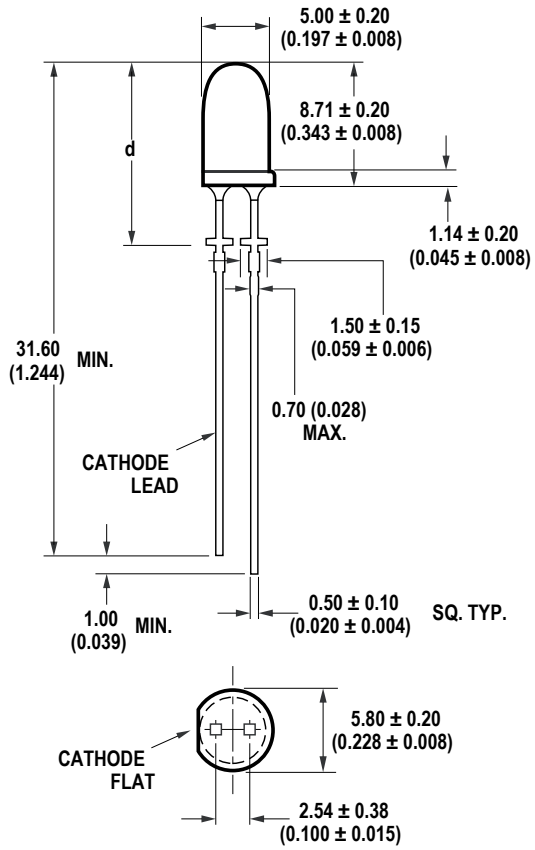

HLMP-Cx16	HLMP-Cx24	HLMP-Cx31
d = 12.6 ± 0.18	d = 12.40 ± 0.25	d = 12.22 ± 0.50
(0.496 ± 0.007)	(0.488 ± 0.010)	(0.481 ± 0.020)

Notes:

1. Dimensions in mm.
2. Tolerance ± 0.1 mm unless otherwise noted.

Absolute Maximum Ratings at $T_A = 25^\circ\text{C}$

Parameter	Value	Units
DC Forward Current ^[1]	30	mA
Peak Forward Current	100	mA
Power Dissipation		mW
Blue	111	
Green / Cyan	117	
Reverse Voltage ($I_R = 100 \mu\text{A}$)	5	V
LED Junction Temperature	130	$^\circ\text{C}$
Operating Temperature Range	-40 to +80	$^\circ\text{C}$
Storage Temperature Range	-40 to +100	$^\circ\text{C}$

Note:

1. Derate linearly as shown in Figure 4 for temperatures above 50°C .
2. Duty Factor 10%, 1kHz

Electrical/Optical Characteristics at $T_A = 25^\circ\text{C}$

Parameter	Symbol	Min.	Typ.	Max.	Units	Test Conditions
Forward Voltage	V_F				V	$I_F = 20 \text{ mA}$
Blue			3.2	3.7		
Green / Cyan			3.2	3.9		
Reverse Voltage	V_R	5				$I_R = 100 \mu\text{A}$
Peak Wavelength	λ_{peak}				nm	Peak of Wavelength of Spectral Distribution at $I_F = 20 \text{ mA}$
Blue ($\lambda_d = 472 \text{ nm}$)			470			
Green ($\lambda_d = 526 \text{ nm}$)			524			
Cyan ($\lambda_d = 505 \text{ nm}$)			502			
Spectral Halfwidth	$\Delta\lambda_{1/2}$				nm	Wavelength Width at Spectral Power Point at $I_F = 20 \text{ mA}$
Blue ($\lambda_d = 472 \text{ nm}$)			35			
Green ($\lambda_d = 526 \text{ nm}$)			47			
Cyan ($\lambda_d = 505 \text{ nm}$)			35			
Capacitance	C				pF	$V_F = 0, F = 1 \text{ MHz}$
Blue/ Green			43			
Cyan			40			
Luminous Efficacy	η_V				lm/W	Emitted Luminous Power/Emitted Radiant Power
Blue ($\lambda_d = 472 \text{ nm}$)			75			
Green ($\lambda_d = 526 \text{ nm}$)			520			
Cyan ($\lambda_d = 505 \text{ nm}$)			350			
Thermal Resistance	$R\theta_{J-PIN}$		240		$^\circ\text{C}/\text{W}$	LED Junction-to-Cathode Lead

Notes:

1. The dominant wavelength, λ_d , is derived from the CIE Chromaticity Diagram and represents the perceived color of the device.
2. The radiant intensity, I_e in watts per steradian, may be found from the equation $I_e = I_v/\eta_V$, where I_v is the luminous intensity in candelas and η_V is the luminous efficacy in lumens/watt.

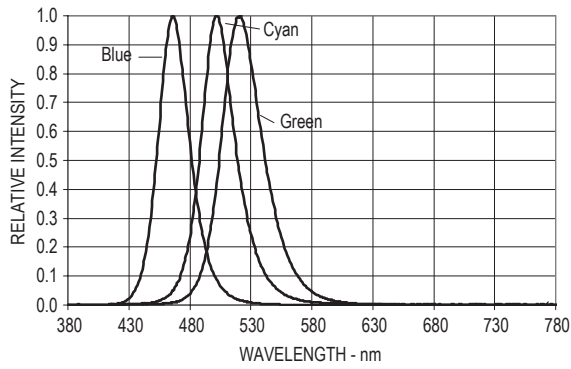

Figure 1. Relative intensity vs. wavelength.

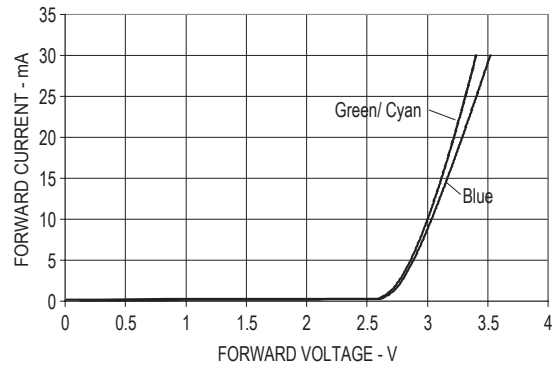

Figure 2 : Forward current vs. forward voltage.

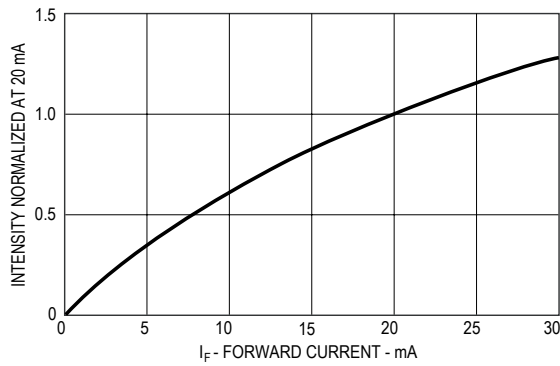

Figure 3. Relative luminous intensity vs. forward current.

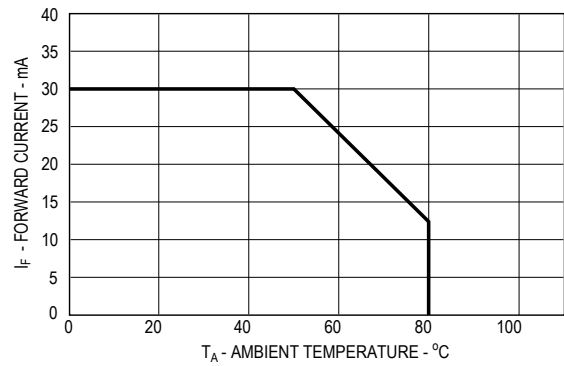

Figure 4. Maximum forward current vs. ambient temperature.

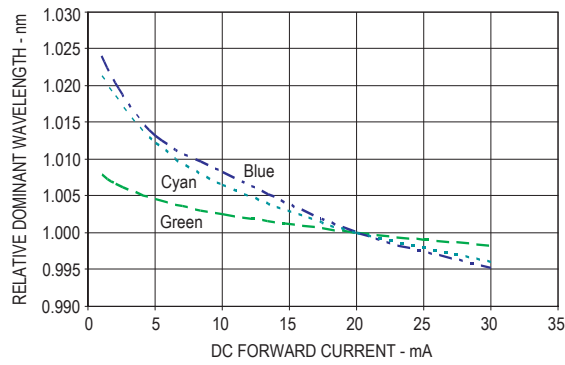

Figure 5. Color vs. forward current

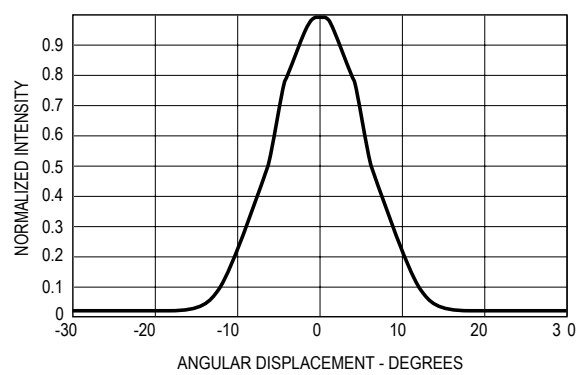

Figure 6. Spatial radiation pattern – 15° lamps.

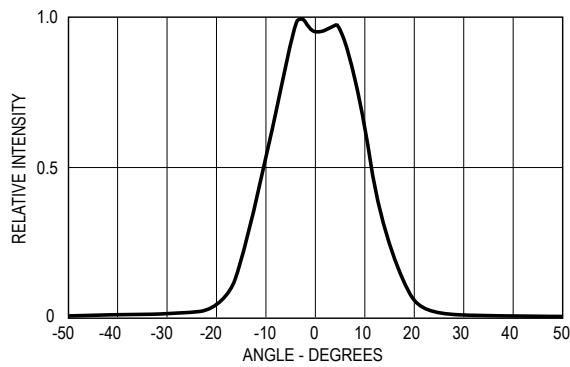

Figure 7. Spatial radiation pattern – 23° lamps.

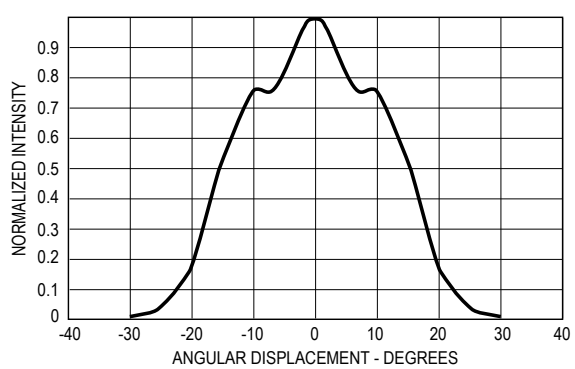

Figure 8. Spatial radiation pattern – 30° lamps.

Color Bin Limits (nm at 20 mA)

Blue Bin ID	Color Range (nm)	
	Min.	Max.
1	460.0	464.0
2	464.0	468.0
3	468.0	472.0
4	472.0	476.0
5	476.0	480.0

Tolerance for each bin limit is ± 0.5 nm.

Green Bin ID	Color Range (nm at 20mA)	
	Min.	Max.
1	520.0	524.0
2	524.0	528.0
3	528.0	532.0
4	532.0	536.0
5	536.0	540.0

Tolerance for each bin limit is ± 0.5 nm.

Cyan Bin ID	Color Range (nm)	
	Min.	Max.
1		
2	495	500
3	500	505
4	505	510
7	498	503
8	503	508

Tolerance for each bin limit is ± 0.5 nm

Intensity Bin Limits

Bin Name	Min.	Max.
K	310	400
L	400	520
M	520	680
N	680	880
P	880	1150
Q	1150	1500
R	1500	1900
S	1900	2500
T	2500	3200
U	3200	4200
V	4200	5500
W	5500	7200
X	7200	9300
Y	9300	12000
Z	12000	16000

Tolerance for each intensity bin limit is $\pm 15\%$.

Note:

- All bin categories are established for classification of products. Products may not be available in all bin categories. Please contact your Avago representatives for further information.

Relative Light Output vs. Junction Temperature

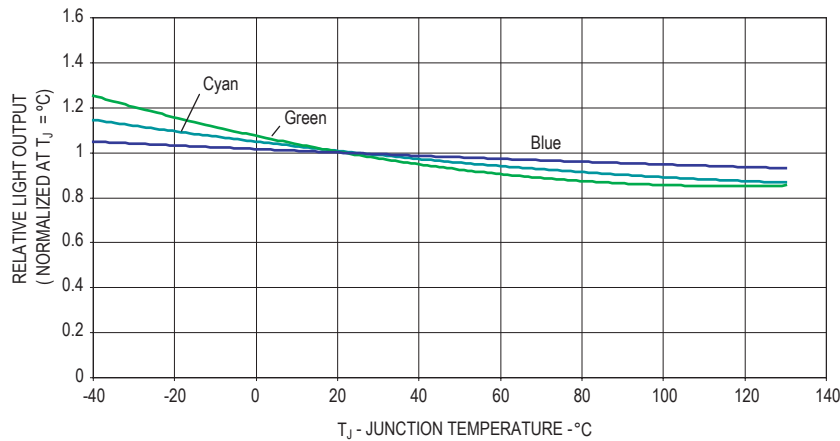

Precautions:

Lead Forming:

- The leads of an LED lamp may be performed or cut to length prior to insertion and soldering on PC board.
- If lead forming is required before soldering, care must be taken to avoid any excessive mechanical stress that induced into the LED package. Otherwise, cut the leads to applicable length after soldering process at room temperature. The solder joint formed will absorb the mechanical stress, due to the lead cutting, from traveling to the LED chip die attach and wirebond.
- For better control, it is recommended to use proper tool to precisely form and cut the leads to applicable length rather than doing it manually.

Soldering condition:

- Care must be taken during PCB assembly and soldering process to prevent damage to the LED component.
- The closest manual soldering distance of the soldering heat source (soldering iron's tip) to the body is 1.59mm. Soldering the LED closer than 1.59mm might damage the LED.

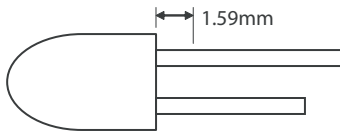

- Recommended soldering condition:

	Wave Soldering	Manual Solder Dipping
Pre-heat temperature	105 °C Max.	-
Preheat time	30 sec Max	-
Peak temperature	250 °C Max.	260 °C Max.
Dwell time	3 sec Max.	5 sec Max

- Wave soldering parameter must be set and maintain according to the recommended temperature and dwell time. Customer is advised to daily check on the soldering profile to ensure that the soldering profile is always conforming to recommended soldering condition.

Note:

1. PCB with different size and design (component density) will have different heat mass (heat capacity). This might cause a change in temperature experienced by the board if same wave soldering setting is used. So, it is recommended to re-calibrate the soldering profile again before loading a new type of PCB.
2. Avago Technologies' high brightness LED are using high efficiency LED die with single wire bond as shown below. Customer is advised to take extra precaution during wave soldering to ensure that the maximum wave temperature is not exceeding 250°C. Over-stressing the LED during soldering process might cause premature failure to the LED due to delamination.

Avago Technologies LED configuration

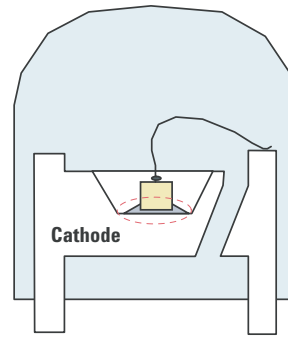

Note: Electrical connection between bottom surface of LED die and the lead frame material through conductive paste of solder.

- If necessary, use fixture to hold the LED component in proper orientation with respect to the PCB during soldering process.
- At elevated temperature, the LED is more susceptible to mechanical stress. Therefore, PCB must allowed to cool down to room temperature prior to handling, which includes removal of jigs, fixtures or pallet.
- Special attention must be given to board fabrication, solder masking, surface plating and lead holes size and component orientation to assure the solderability.
- Recommended PC board plated through holes size for LED component leads.

LED component lead size	Diagonal	Plated through hole diameter
0.457 x 0.457 mm (0.018 x 0.018 inch)	0.646 mm (0.025 inch)	0.976 to 1.078 mm (0.038 to 0.042 inch)
0.508 x 0.508 mm (0.020 x 0.020 inch)	0.718 mm (0.028 inch)	1.049 to 1.150 mm (0.041 to 0.045 inch)

- Over sizing of plated through hole can lead to twisting or improper LED placement during auto insertion. Under sizing plated through hole can lead to mechanical stress on the epoxy lens during clinching.

Note: Refer to application note AN1027 for more information on soldering LED components.

Recommended Wave Soldering Profile

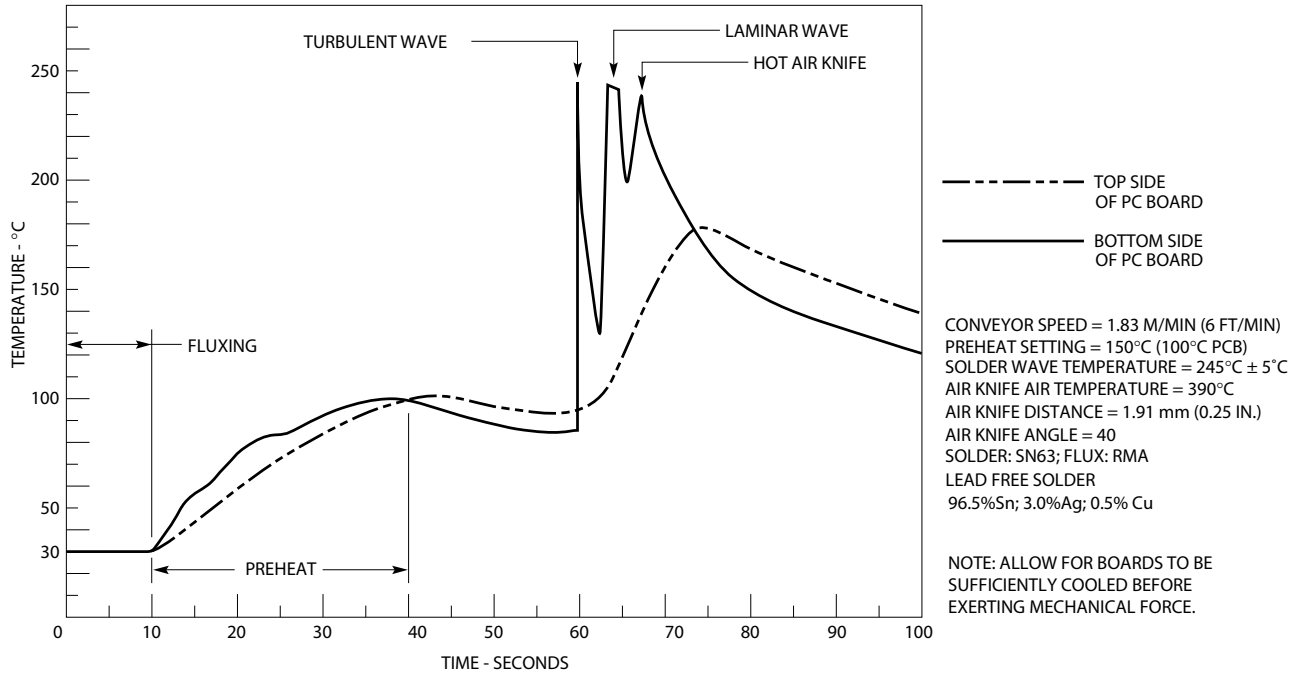

Ammo Packs Drawing

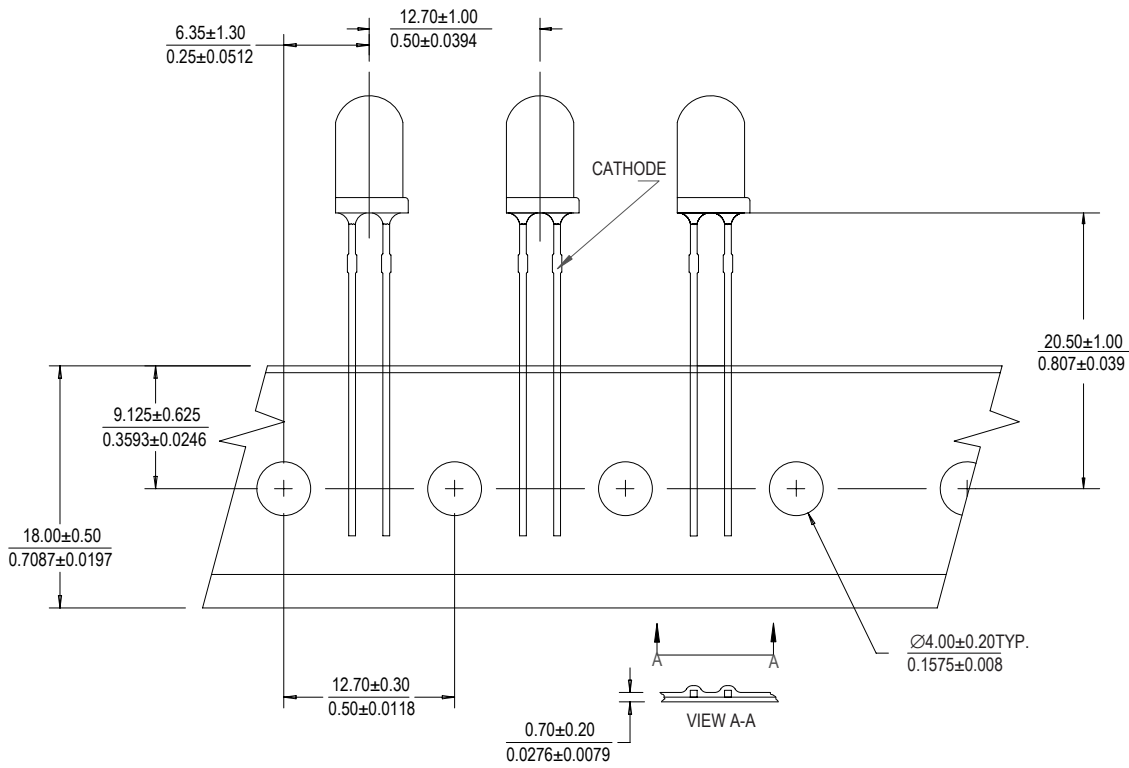

Note: The ammo-packs drawing is applicable for packaging option -DD & -ZZ and regardless standoff or non-standoff

Packaging Box for Ammo Packs

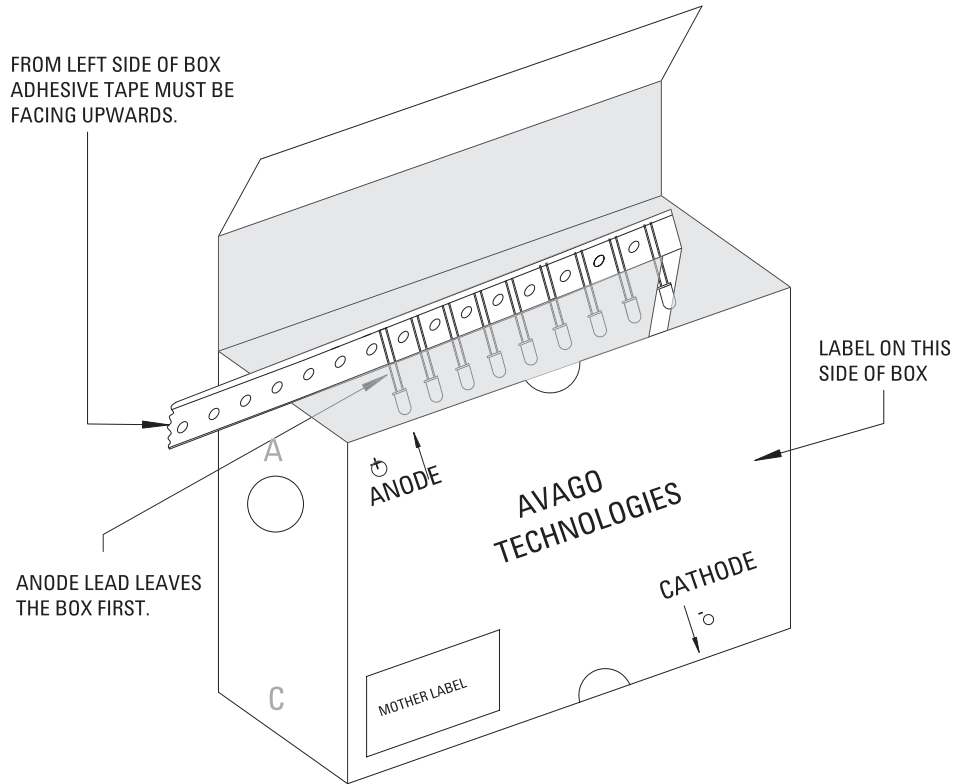

Note: For InGaN device, the ammo pack packaging box contain ESD logo

DISCLAIMER

AVAGO TECHNOLOGIES' PRODUCTS AND SOFTWARE ARE NOT SPECIFICALLY DESIGNED, MANUFACTURED OR AUTHORIZED FOR SALE AS PARTS, COMPONENTS OR ASSEMBLIES FOR THE PLANNING, CONSTRUCTION, MAINTENANCE OR DIRECT OPERATION OF A NUCLEAR FACILITY OR FOR USE IN MEDICAL DEVICES OR APPLICATIONS. CUSTOMER IS SOLELY RESPONSIBLE, AND WAIVES ALL RIGHTS TO MAKE CLAIMS AGAINST AVAGO OR ITS SUPPLIERS, FOR ALL LOSS, DAMAGE, EXPENSE OR LIABILITY IN CONNECTION WITH SUCH USE.

For product information and a complete list of distributors, please go to our web site: www.avagotech.com

Avago, Avago Technologies, and the A logo are trademarks of Avago Technologies, Limited in the United States and other countries. Data subject to change. Copyright © 2007 Avago Technologies Limited. All rights reserved.
AV02-0213EN - March 21, 2007

AVAGO
TECHNOLOGIES