



Chipsmall Limited consists of a professional team with an average of over 10 year of expertise in the distribution of electronic components. Based in Hongkong, we have already established firm and mutual-benefit business relationships with customers from,Europe,America and south Asia,supplying obsolete and hard-to-find components to meet their specific needs.

With the principle of “Quality Parts,Customers Priority,Honest Operation,and Considerate Service”,our business mainly focus on the distribution of electronic components. Line cards we deal with include Microchip,ALPS,ROHM,Xilinx,Pulse,ON,Everlight and Freescale. Main products comprise IC,Modules,Potentiometer,IC Socket,Relay,Connector.Our parts cover such applications as commercial,industrial, and automotives areas.

We are looking forward to setting up business relationship with you and hope to provide you with the best service and solution. Let us make a better world for our industry!



Contact us

Tel: +86-755-8981 8866 Fax: +86-755-8427 6832

Email & Skype: info@chipsmall.com Web: www.chipsmall.com

Address: A1208, Overseas Decoration Building, #122 Zhenhua RD., Futian, Shenzhen, China



HLMP-DB25, HLMP-KB45

T-1¾ (5 mm), T-1 (3 mm)

Blue LED Lamps



Data Sheet



Description

These blue LEDs are designed in industry standard T-1 and T-1¾ package with clear and non diffused optics. They are also available in tape and reel, and ammo-pack option for ease of handling and use.

These blue lamps are ideal for use as indicators and for general purpose lighting. Blue lamps offer color differentiation as blue is attractive and not widely available.

Features

- Popular T-1¾ and T-1 diameter packages
- General purpose leads
- Reliable and rugged
- Available on tape and reel
- Binned for color and intensity

Applications

- Status indicators
- Small message panel
- Running and decorative lights for commercial use

Package Dimensions

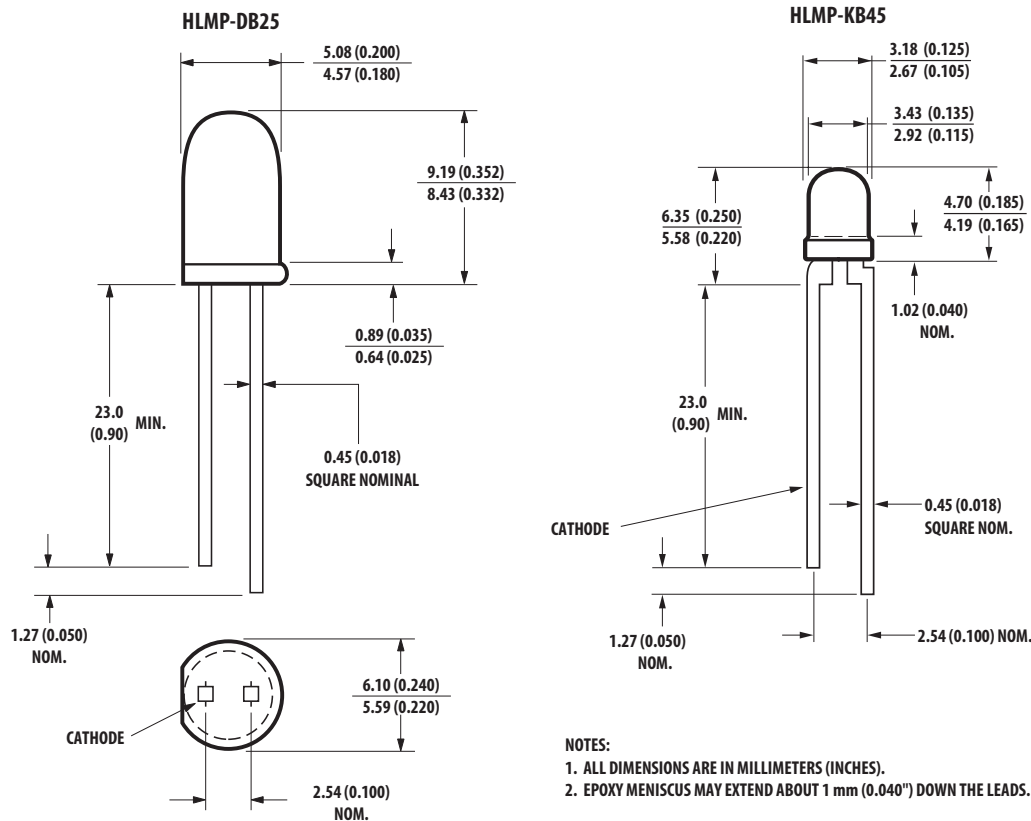

CAUTION: Devices are Class 1C HBM ESD sensitive per JEDEC Standard. Please observe appropriate precautions during handling and processing. Refer to Application Note AN-1142 for additional details.

Selection Guide

| Part Number | Package | Viewing Angle | Luminous Intensity I _v (mcd) | |
|-----------------|---------|---------------|---|------|
| | | | Min. | Max. |
| HLMP-KB45-A0000 | T-1 | 40 | 30 | – |
| HLMP-DB25-B0000 | T-1¾ | 25 | 40 | – |

Part Numbering System

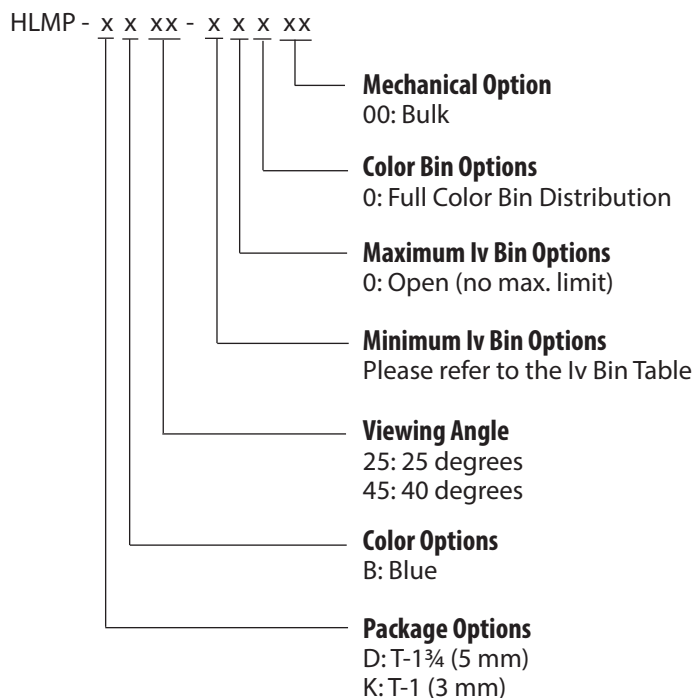

Absolute Maximum Ratings at T_A = 25°C

| Parameter | Blue | Units |
|--|----------------------------------|-------|
| Peak Forward Current | 70 | mA |
| DC Current ^[1] | 30 | mA |
| Reverse Voltage | Not recommended for reverse bias | |
| Transient Forward Current ^[2] (10 µsec Pulse) | 350 | mA |
| LED Junction Temperature | 115 | °C |
| Operating Temperature | -20 to +80 | °C |
| Storage Temperature | -30 to +100 | °C |
| Wave Soldering Temperature [1.59 mm (0.063 in.) from Body] | 250°C for 3 seconds | |
| Solder Dipping Temperature [1.59 mm (0.063 in.) from Body] | 260°C for 5 seconds | |

Notes:

- Derate linearly from 50°C as shown in Figure 6.
- The transient peak current is the maximum non-recurring peak current that can be applied to the device without damaging the LED die and wirebond. It is not recommended that this device be operated at peak currents above the Absolute Maximum Peak Forward Current.

Optical Characteristics at $T_A = 25^\circ\text{C}$

| Part Number | Luminous Intensity | Color, Dominant Wavelength | Peak Wavelength | Viewing Angle |
|-----------------|--|--------------------------------|--------------------------------------|---------------------------------------|
| | I_V (mcd) @ $I_F = 20\text{ mA}$ Min. | $\lambda_d^{[1]}$ (nm) Typ. | λ_{PEAK} (nm) Typ. | $2\theta_{1/2}^{[2]}$ Degrees Typ. |
| HLMP-DB25-B0000 | 40 | 470 | 464 | 25 |
| HLMP-KB45-A0000 | 30 | 470 | 464 | 40 |

Notes:

- The dominant wavelength, λ_d , is derived from the CIE chromaticity diagram and represents the single wavelength which defines the color of the device.
- $\theta_{1/2}$ is the off-axis angle at which the luminous intensity is half of the axial luminous intensity.

Electrical Characteristics at $T_A = 25^\circ\text{C}$

| Part Number | Forward Voltage | | Speed Response | Capacitance | Thermal Resistance |
|-----------------|---|------|-----------------------|---|--|
| | V_F (Volts) @ $I_F = 20\text{ mA}$ Typ. | Max. | τ_s (ns) Typ. | C (pF), $V_F = 0$, $f = 1\text{ MHz}$ Typ. | $R\theta_{\text{J-PIN}}$ ($^\circ\text{C}/\text{W}$) Junction to Cathode Lead Typ. |
| HLMP-DB25-B00xx | 3.2 | 3.8 | 500 | 97 | 260 |
| HLMP-KB45-A00xx | 3.2 | 3.8 | 500 | 97 | 290 |

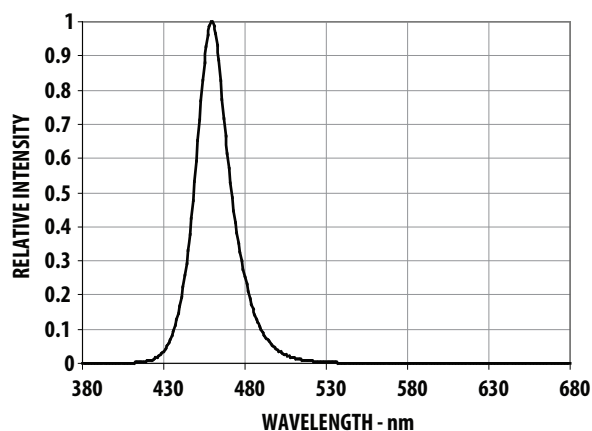

Figure 1. Relative intensity vs. wavelength

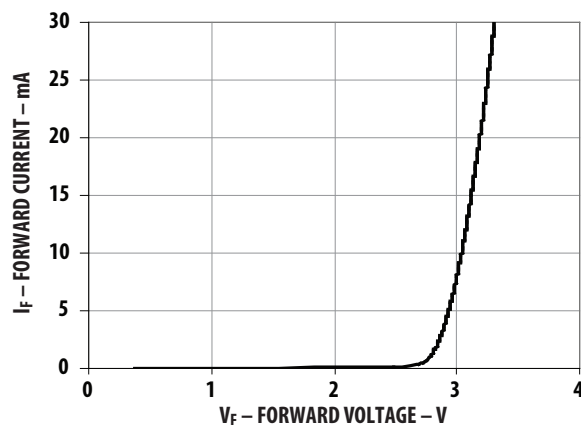

Figure 2. Forward current vs. forward voltage

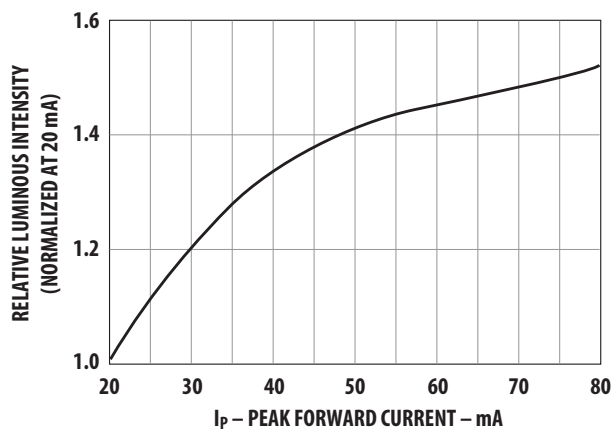

Figure 3. Relative intensity vs. peak forward current (300 μs pulse width, 10 ms period)

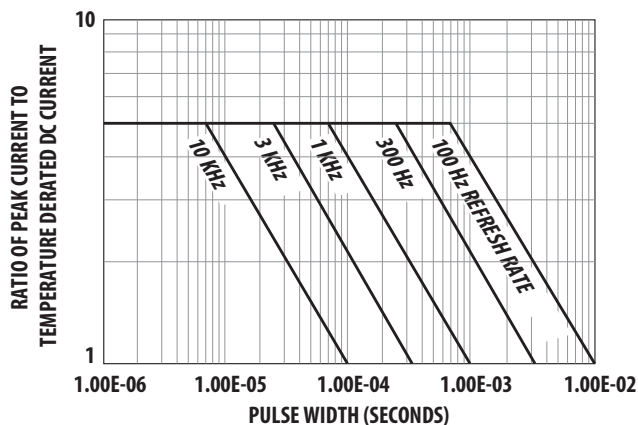

Figure 4. Maximum Tolerable Peak Current vs Pulse Width

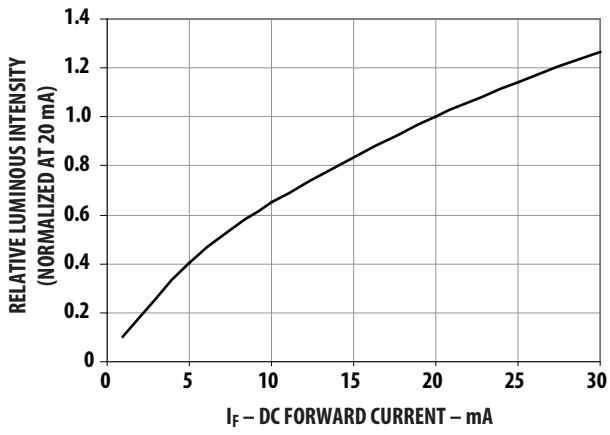

Figure 5. Relative luminous intensity vs. forward current

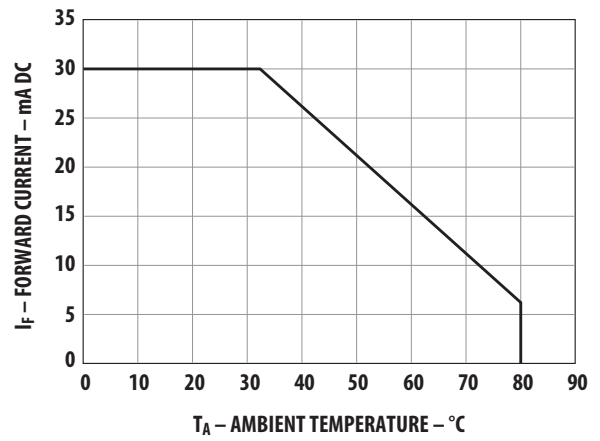

Figure 6. Maximum DC forward current vs. ambient temperature. Derating based on T_J max. = 115°C

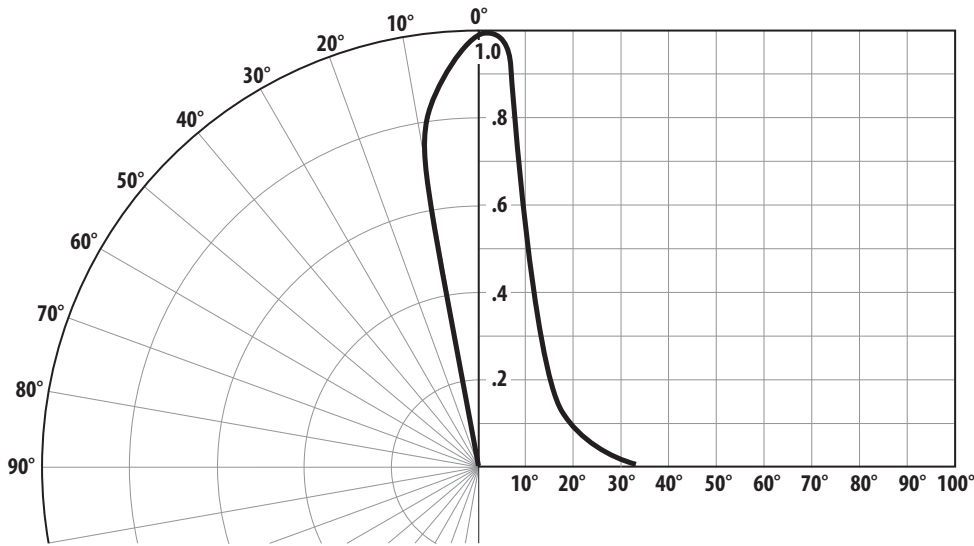

Figure 7. Relative luminous intensity vs. angular displacement for HLMP-DB25

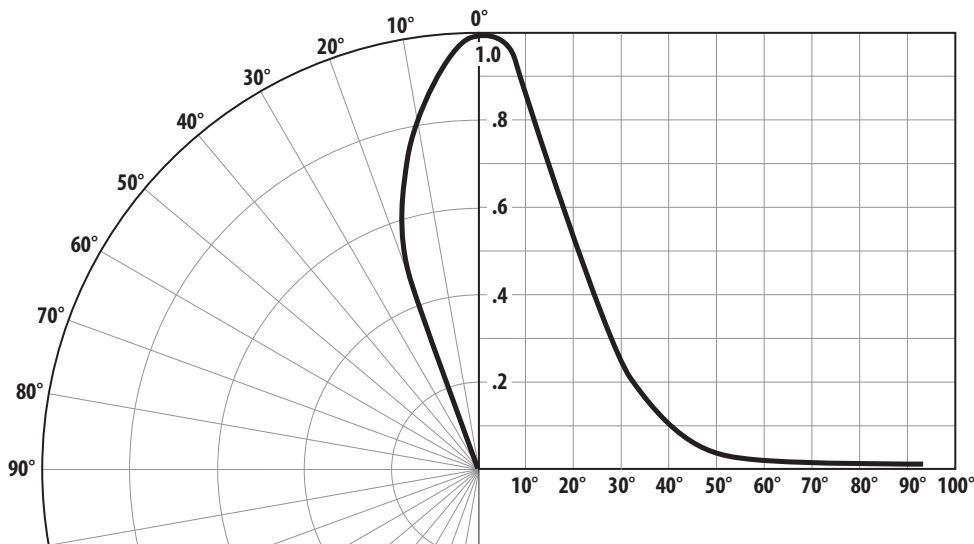

Figure 8. Relative luminous intensity vs. angular displacement for HLMP-KB45

Soldering/Cleaning

Cleaning agents from the ketone family (acetone, methyl ethyl ketone, etc.) and from the chlorinated hydrocarbon family (methylene chloride, trichloro-ethylene, carbon tetrachloride, etc.) are not recommended for cleaning LED parts. All of these various solvents attack or dissolve the encapsulating epoxies used to form the package of plastic LED parts.

Intensity Bin Limits

| Bin ID | Intensity Range (mcd) | |
|--------|-----------------------|------|
| | Min | Max |
| A | 30 | 40 |
| B | 40 | 50 |
| C | 50 | 65 |
| D | 65 | 85 |
| E | 85 | 110 |
| F | 110 | 140 |
| G | 140 | 180 |
| H | 180 | 240 |
| J | 240 | 310 |
| K | 310 | 400 |
| L | 400 | 520 |
| M | 520 | 680 |
| N | 680 | 880 |
| P | 880 | 1150 |
| Q | 1150 | 1500 |
| R | 1500 | 1900 |
| S | 1900 | 2500 |
| T | 2500 | 3200 |
| U | 3200 | 4200 |

Tolerance for each bin limit is $\pm 15\%$.

Color Bin Limits (nm at 20 mA)

| Bin ID | Blue nm @ 20 mA | |
|--------|-----------------|-------|
| | Min. | Max. |
| 1 | 460.0 | 464.0 |
| 2 | 464.0 | 468.0 |
| 3 | 468.0 | 472.0 |
| 4 | 472.0 | 476.0 |
| 5 | 476.0 | 480.0 |

Tolerance for each bin limit is ± 0.5 nm.

Mechanical Option Matrix

| Mechanical Option Code | Definition |
|------------------------|---|
| 00 | Bulk Packaging, minimum increment 500 pcs/bag |

Note:

All categories are established for classification of products. Products may not be available in all categories. Please contact your local Avago representative for further clarification/information.

Precautions:

Lead Forming:

- The leads of an LED lamp may be preformed or cut to length prior to insertion and soldering on PC board.
- For better control, it is recommended to use proper tool to precisely form and cut the leads to applicable length rather than doing it manually.
- If manual lead cutting is necessary, cut the leads after the soldering process. The solder connection forms a mechanical ground which prevents mechanical stress due to lead cutting from traveling into LED package. This is highly recommended for hand solder operation, as the excess lead length also acts as small heat sink.

Soldering and Handling:

- Care must be taken during PCB assembly and soldering process to prevent damage to the LED component.
- LED component may be effectively hand soldered to PCB. However, it is only recommended under unavoidable circumstances such as rework. The closest manual soldering distance of the soldering heat source (soldering iron's tip) to the body is 1.59mm. Soldering the LED using soldering iron tip closer than 1.59mm might damage the LED.

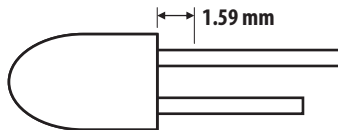

- ESD precaution must be properly applied on the soldering station and by personnel to prevent ESD damage to the LED component that is ESD sensitive. For details, refer to Avago application note AN 1142. The soldering iron used should have grounded tip to ensure electrostatic charge is properly grounded.
- Recommended soldering conditions:

| | Wave Soldering ^{[1],[2]} | Manual Solder Dipping |
|----------------------|-----------------------------------|-----------------------|
| Pre-heat Temperature | 105°C Max. | – |
| Pre-heat Time | 60 sec Max. | – |
| Peak Temperature | 250°C Max. | 260°C Max. |
| Dwell Time | 3 sec Max. | 5 sec Max. |

Notes:

1. These conditions refer to measurement with a thermocouple mounted at the bottom of PCB.
2. To reduce thermal stress experienced by LED, it is recommended that you use only bottom preheaters.

- Wave soldering parameters must be set and maintained according to the recommended temperature and dwell time. Customer is advised to perform daily check on the soldering profile to ensure that it is always conforming to recommended soldering conditions.

Note:

1. PCB with different size and design (component density) will have different heat mass (heat capacity). This might cause a change in temperature experienced by the board if same wave soldering setting is used. So, it is recommended to re-calibrate the soldering profile again before loading a new type of PCB.
 2. Customer is advised to take extra precaution during wave soldering to ensure that the maximum wave temperature does not exceed 250°C and the solder contact time does not exceeding 3sec. Over-stressing the LED during soldering process might cause premature failure to the LED due to delamination.
- Any alignment fixture that is being applied during wave soldering should be loosely fitted and should not apply weight or force on LED. Non metal material is recommended as it will absorb less heat during wave soldering process.
 - At elevated temperature, LED is more susceptible to mechanical stress. Therefore, PCB must allowed to cool down to room temperature prior to handling, which includes removal of alignment fixture or pallet.
 - If PCB board contains both through hole (TH) LED and other surface mount components, it is recommended that surface mount components be soldered on the top side of the PCB. If surface mount need to be on the bottom side, these components should be soldered using reflow soldering prior to insertion the TH LED.
 - Recommended PC board plated through holes (PTH) size for LED component leads.

| LED Component Lead Size | Diagonal | Plated Through Hole Diameter |
|---|------------------------|--|
| Lead size (Typical) 0.45 x 0.45 mm (0.018 x 0.018 in) | 0.636 mm (0.025 in) | 0.98 to 1.08 mm (0.039 to 0.043 in) |
| Dambar shear-off area (max) 0.65 mm (0.026 in) | 0.919 mm (0.036 in) | |
| Lead size (Typical) 0.50 x 0.50 mm (0.020 x 0.020 in) | 0.707 mm (0.028 in) | 1.05 to 1.15 mm (0.041 to 0.045 in) |
| Dambar shear-off area (max) 0.70 mm (0.028 in) | 0.99 mm (0.039 in) | |

- Over-sizing the PTH can lead to a twisted LED after it is clinched. On the other hand, undersizing the PTH can cause difficulty in inserting the TH LED.

For more information about soldering and handling of TH LED lamps, refer to application note AN5334.

Example of Wave Soldering Temperature Profile for TH LED

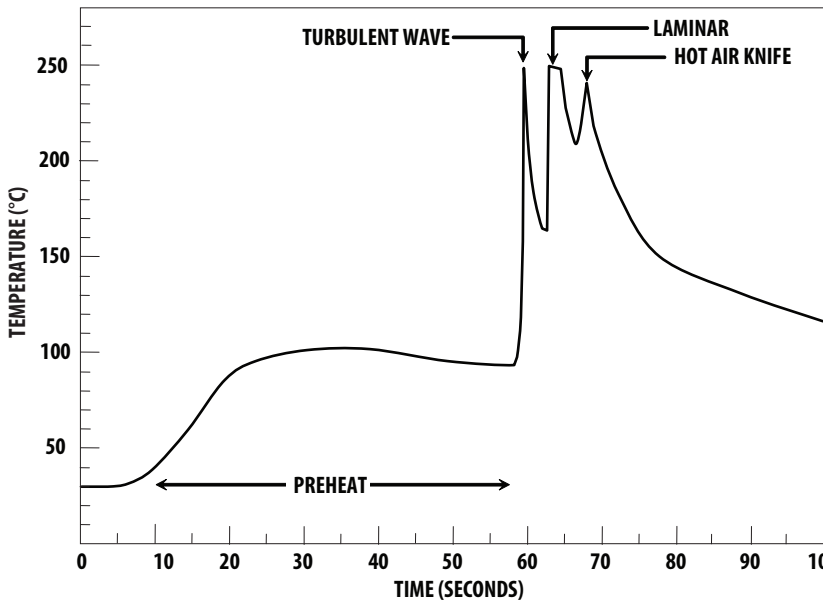

Recommended solder:
Sn63 (Leaded solder alloy)
SAC305 (Lead free solder alloy)

Flux: Rosin flux

Solder bath temperature:
245°C ± 5°C (maximum peak temperature = 250°C)

Dwell time: 1.5 sec – 3.0 sec (maximum = 3sec)

Note: Allow for board to be sufficiently cooled to room temperature before exerting mechanical force.

Recommended solder:
Sn63 (Leaded solder alloy)
SAC305 (Lead free solder alloy)

Flux: Rosin flux

Solder bath temperature:
245°C ± 5°C (maximum peak temperature = 250°C)

Dwell time: 1.5 sec – 3.0 sec (maximum = 3sec)









Note: Allow for board to be sufficiently cooled to room temperature before exerting mechanical force.

Packaging Label:

(i) Avago Mother Label: (Available on packaging box of ammo pack and shipping box)

| | |
|---|---|
| AVAGO TECHNOLOGIES | |
| (1P) Item: Part Number [Barcode] | STANDARD LABEL LS0002 RoHS Compliant e3 max temp 250C |
| (1T) Lot: Lot Number [Barcode] | (Q) QTY: Quantity [Barcode] |
| LPN: [Barcode] | CAT: Intensity Bin [Barcode] |
| (9D)MFG Date: Manufacturing Date [Barcode] | BIN: Color Bin [Barcode] |
| (P) Customer Item: [Barcode] | |
| (V) Vendor ID: [Barcode] | (9D) Date Code: Date Code [Barcode] |
| DeptID: [Barcode] | Made In: Country of Origin [Barcode] |

(ii) Avago Baby Label (Only available on bulk packaging)

| | | | |
|---|--|---|--|
| AVAGO TECHNOLOGIES | | RoHS Compliant e3 max temp 250C | |
| Lamps Baby Label | | | |
| (1P) PART #: Part Number | | | |
|  | | | |
| (1T) LOT #: Lot Number | | | |
|  | | | |
| (9D)MFG DATE: Manufacturing Date | | QUANTITY: Packing Quantity | |
|  | |  | |
| C/O: Country of Origin | | | |
| Customer P/N: | | CAT: Intensity Bin | |
|  | |  | |
| Supplier Code: | | BIN: Color Bin | |
|  | |  | |
| | | DATECODE: Date Code | |
| | |  | |

For product information and a complete list of distributors, please go to our web site: www.avagotech.com

Avago, Avago Technologies, and the A logo are trademarks of Avago Technologies in the United States and other countries. Data subject to change. Copyright © 2005-2014 Avago Technologies. All rights reserved. Obsoletes 5989-3263EN AV02-2213EN - July 24, 2014

