



Chipsmall Limited consists of a professional team with an average of over 10 year of expertise in the distribution of electronic components. Based in Hongkong, we have already established firm and mutual-benefit business relationships with customers from,Europe,America and south Asia,supplying obsolete and hard-to-find components to meet their specific needs.

With the principle of “Quality Parts,Customers Priority,Honest Operation,and Considerate Service”,our business mainly focus on the distribution of electronic components. Line cards we deal with include Microchip,ALPS,ROHM,Xilinx,Pulse,ON,Everlight and Freescale. Main products comprise IC,Modules,Potentiometer,IC Socket,Relay,Connector.Our parts cover such applications as commercial,industrial, and automotives areas.

We are looking forward to setting up business relationship with you and hope to provide you with the best service and solution. Let us make a better world for our industry!



## Contact us

Tel: +86-755-8981 8866 Fax: +86-755-8427 6832

Email & Skype: info@chipsmall.com Web: www.chipsmall.com

Address: A1208, Overseas Decoration Building, #122 Zhenhua RD., Futian, Shenzhen, China







3M™ HM PRESS-FIT SOCKET, 8-ROW, HM SERIES  
FOR HARD METRIC APPLICATIONS

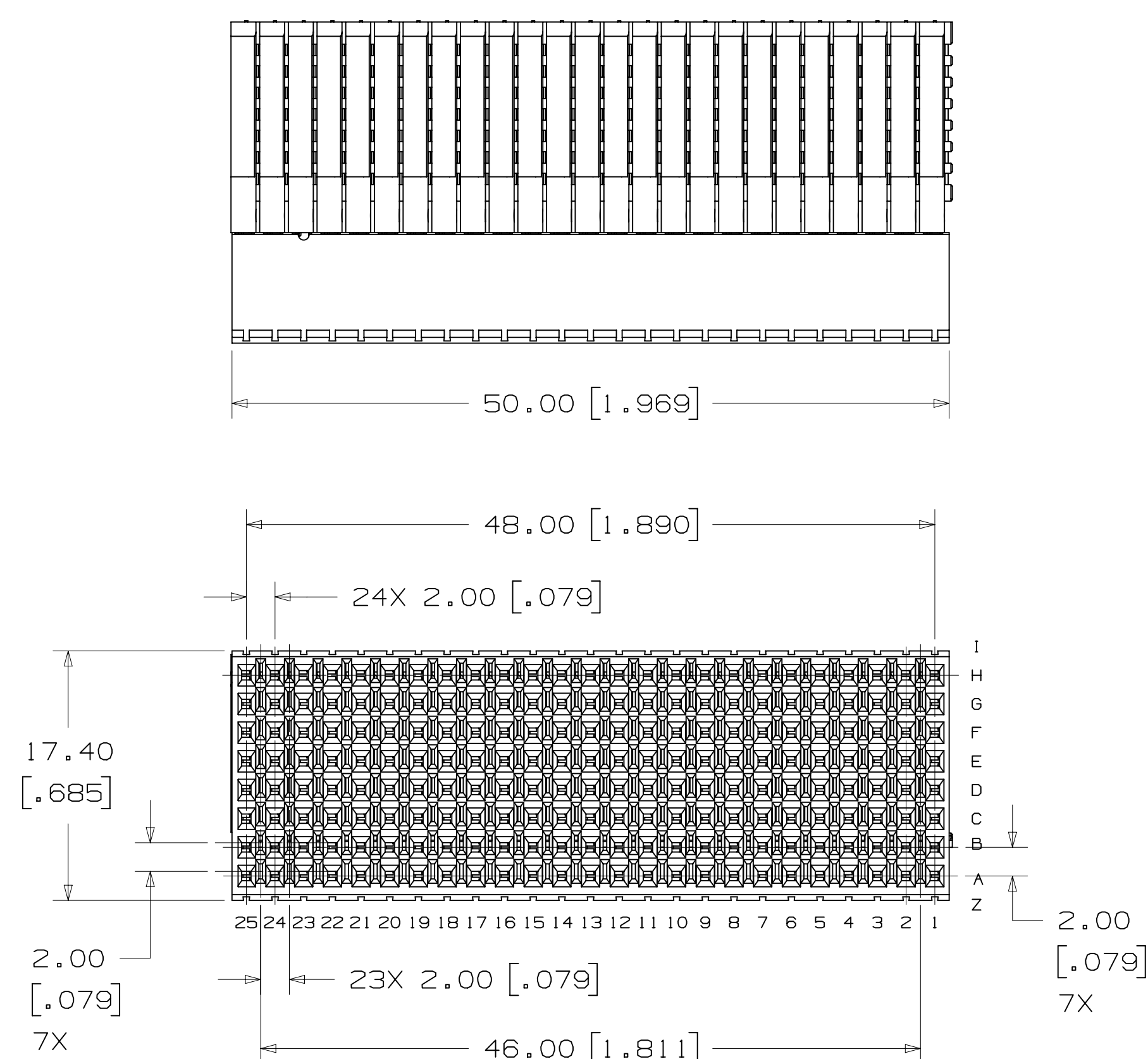

HM-S200E1-8AP1

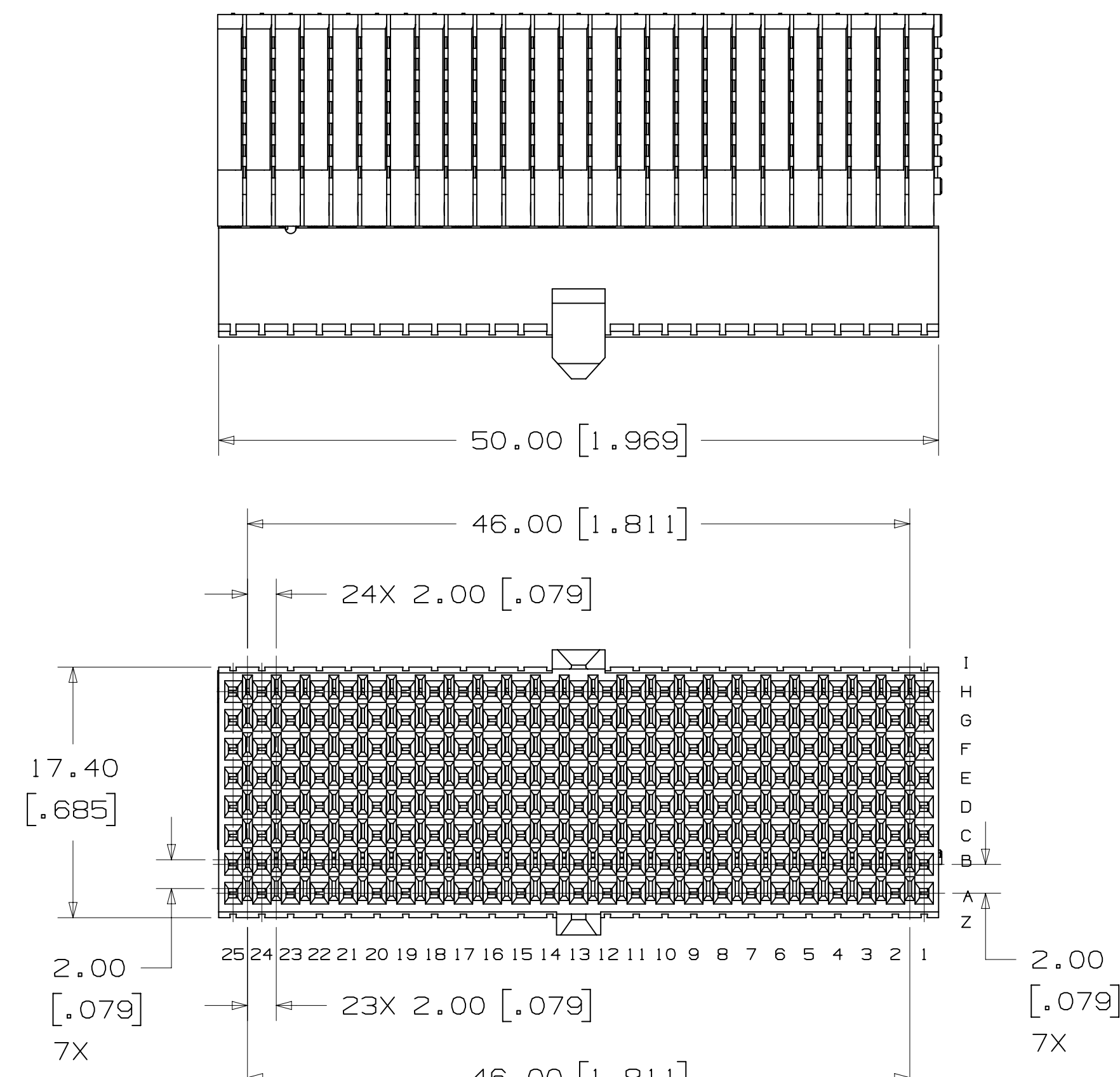

HM-S200DE1-8AP1

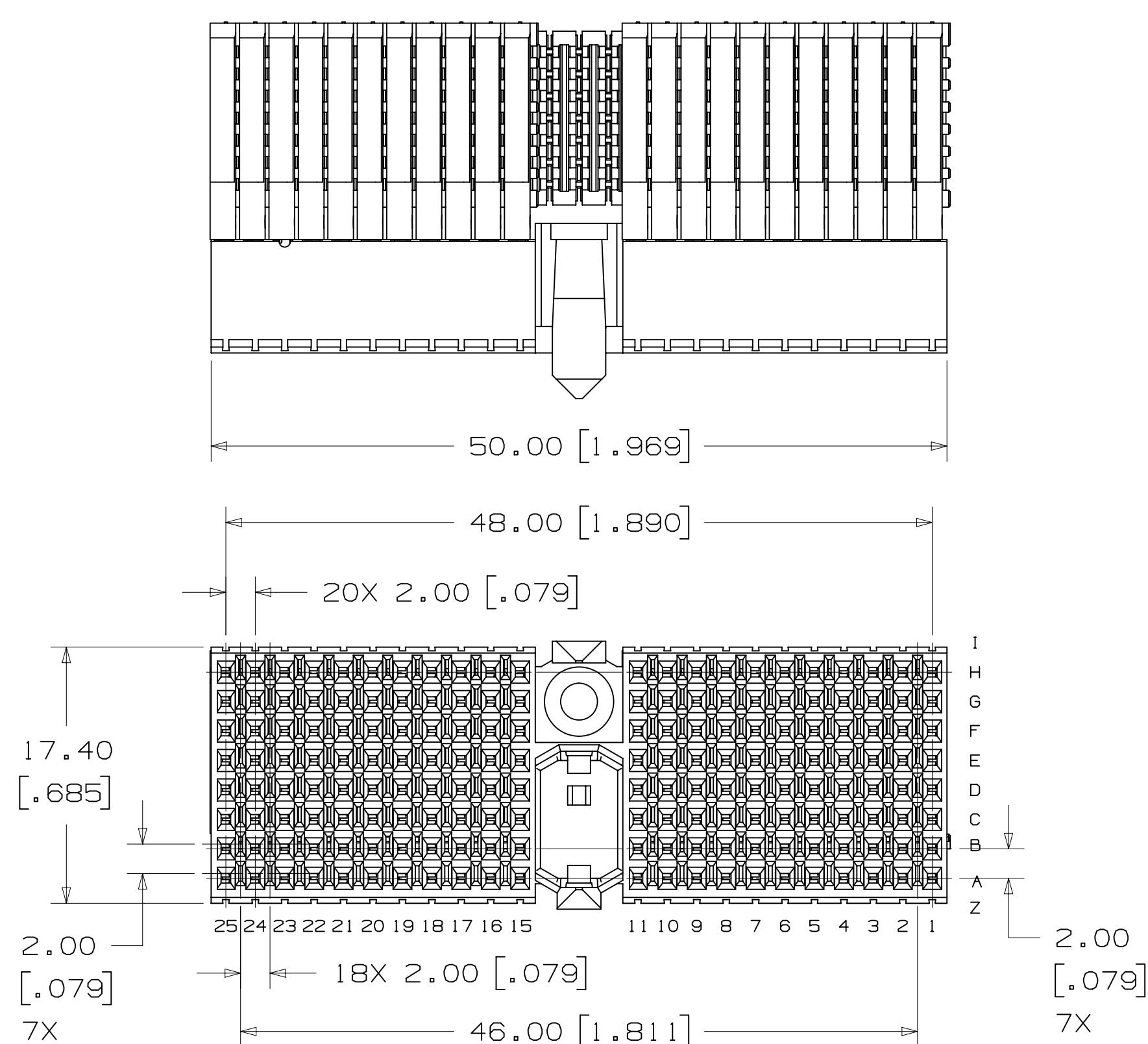

HM-S176D1-8AP1

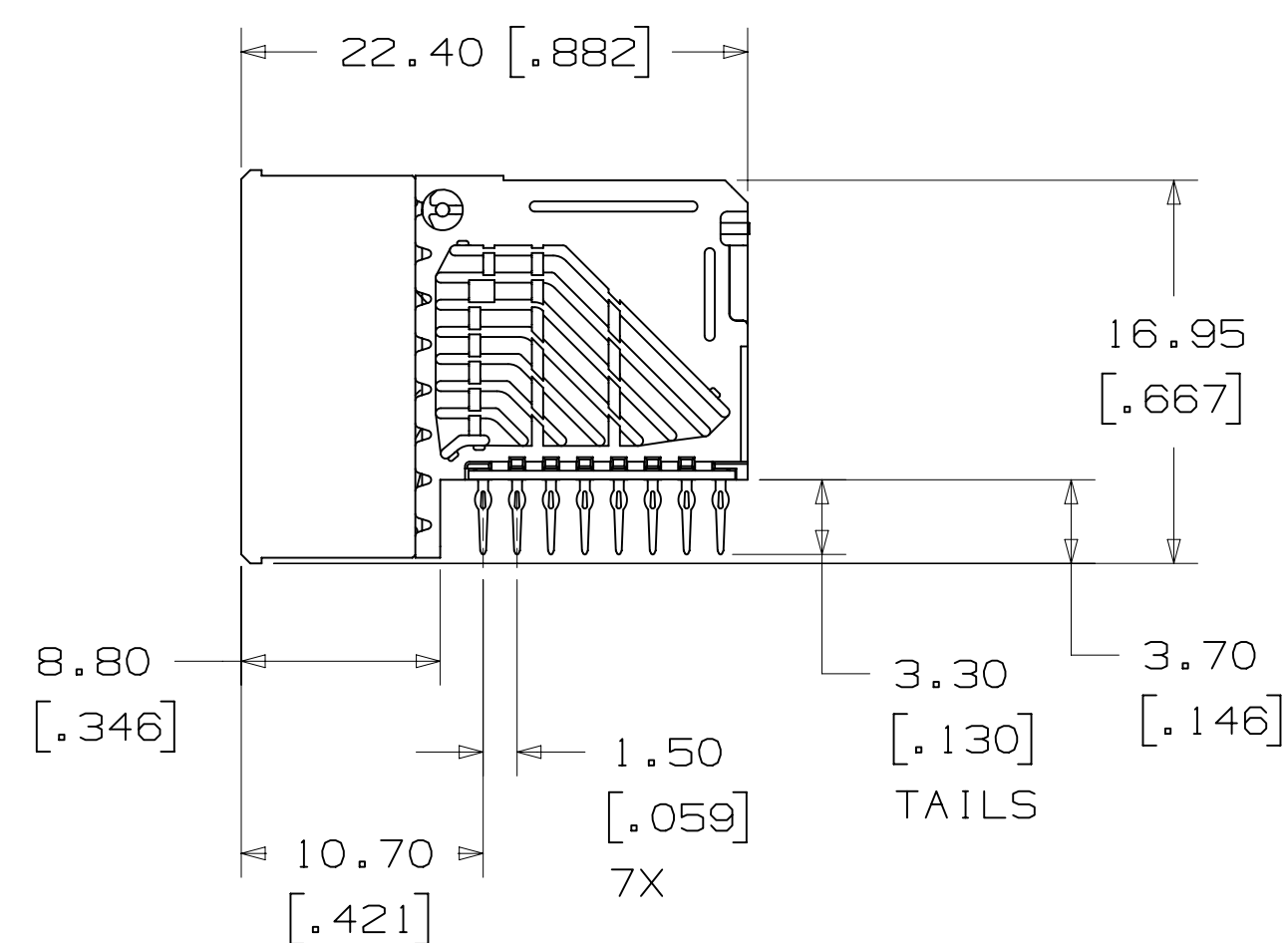

TYPICAL SIDE VIEW DIMENSIONS FOR THE SOCKETS ON THIS DRAWING

DESIGN REFERENCE	NEXT ASSEMBLY	REV	ECO	ISSUE DATE AND DESCRIPTION	DRFT	CHKD
		B	50345	OCT 07, 2013 REMOVED KR PLATING. REVISE RIA CALLOUT	JNC	TS
		A	39778	MAR 23, 2012 PRODUCTION RELEASE	JNC	TS
				MAR 23, 2012		
				MAR 23, 2012		
				MAR 26, 2012		

DO NOT SCALE DRAWING	SCALE	TOLERANCES EXCEPT AS NOTED
	3/1	
		INCHES
		0 ± .01
		.00 ± .005
		.0000 ±
		MILLIMETERS
		0 ± .3
		.00 ± .13
		.000 ±
		ANGLES

3M	© 3M COPYRIGHT 2012
3M Center St. Paul, MN 55144	This document and the information it contains are 3M property and may not be reproduced or further distributed without 3M permission, or used or disclosed other than for 3M authorized purposes. All rights reserved.
TITLE	HM PRESS-FIT 8-ROW SOCKET CONNECTORS, HM SERIES
CAGE NUMBER	D 78-5100-2516-2
SIZE	B
DRAWING NO.	78-5100-2516-2
REV.	B
MODEL	IS1s <input type="checkbox"/> YES <input checked="" type="checkbox"/> NO <input type="checkbox"/> SHT 2 OF 4

78-5100-2516-2  
 DRAWING NUMBER  
 B  
 REVISION  
 A  
 10/7/2013 2:10 PM UTC-05:00  
 Imaged: B.1

3M™ HM PRESS-FIT SOCKET, 8-ROW, HM SERIES  
FOR HARD METRIC APPLICATIONS

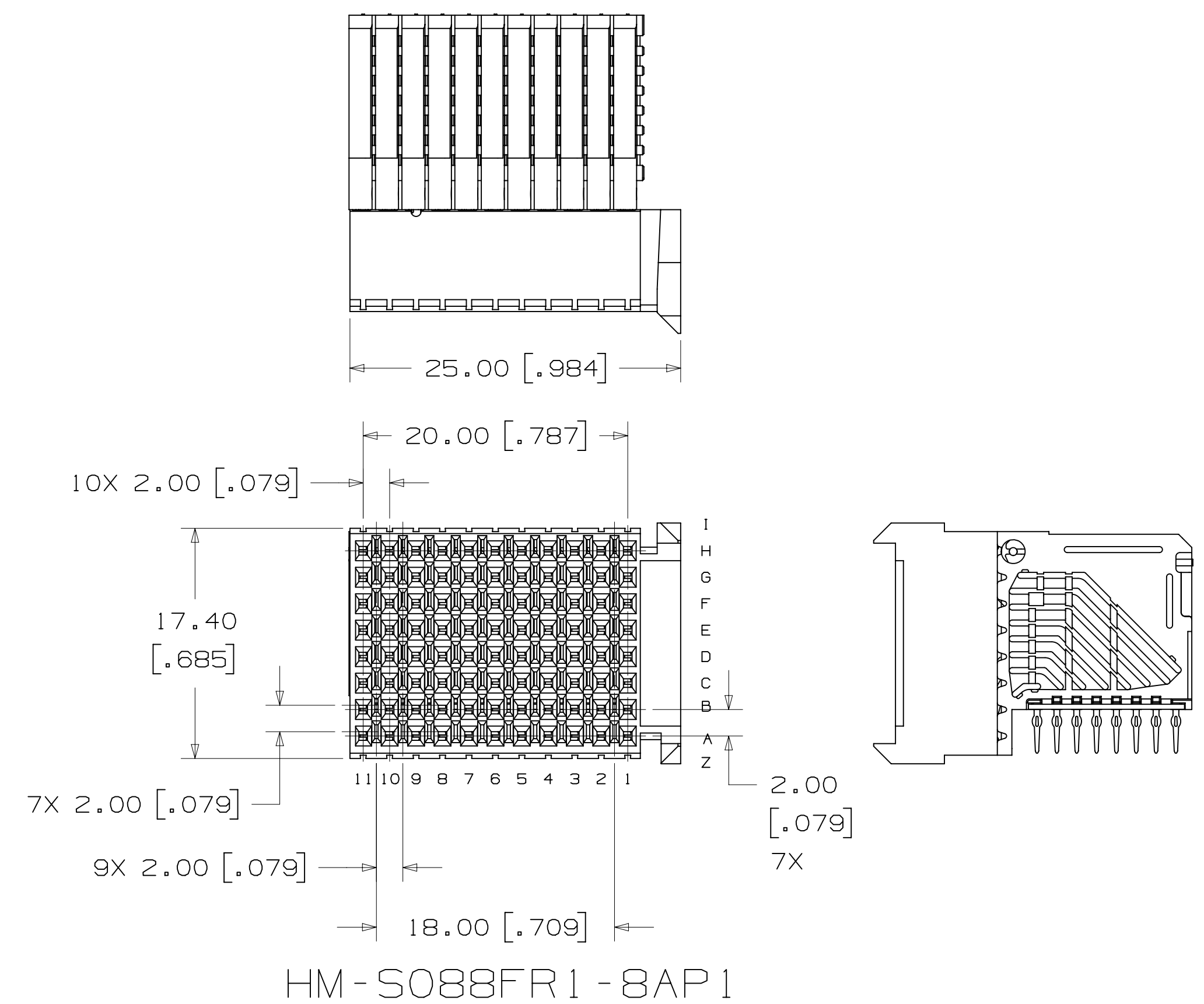
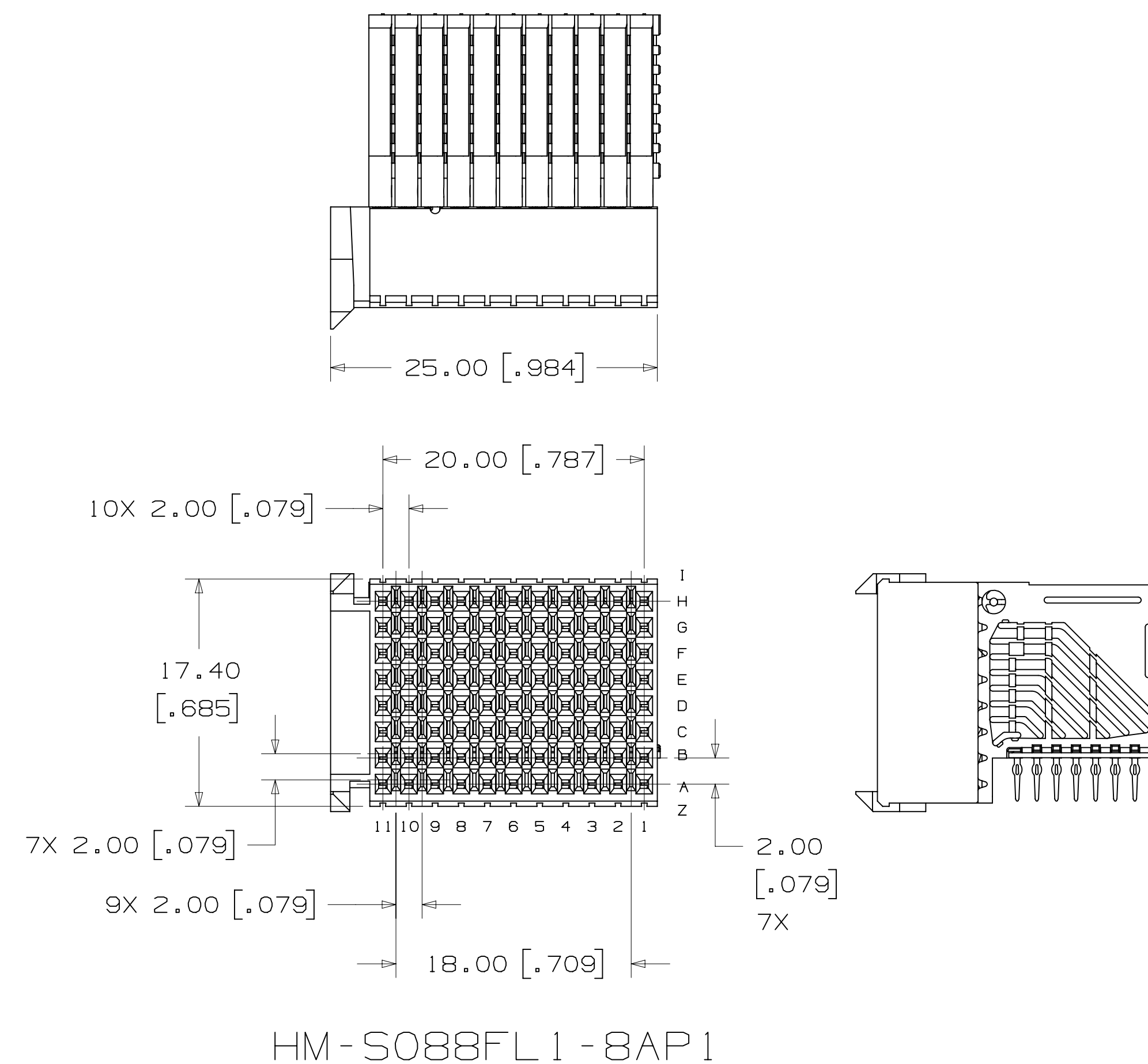
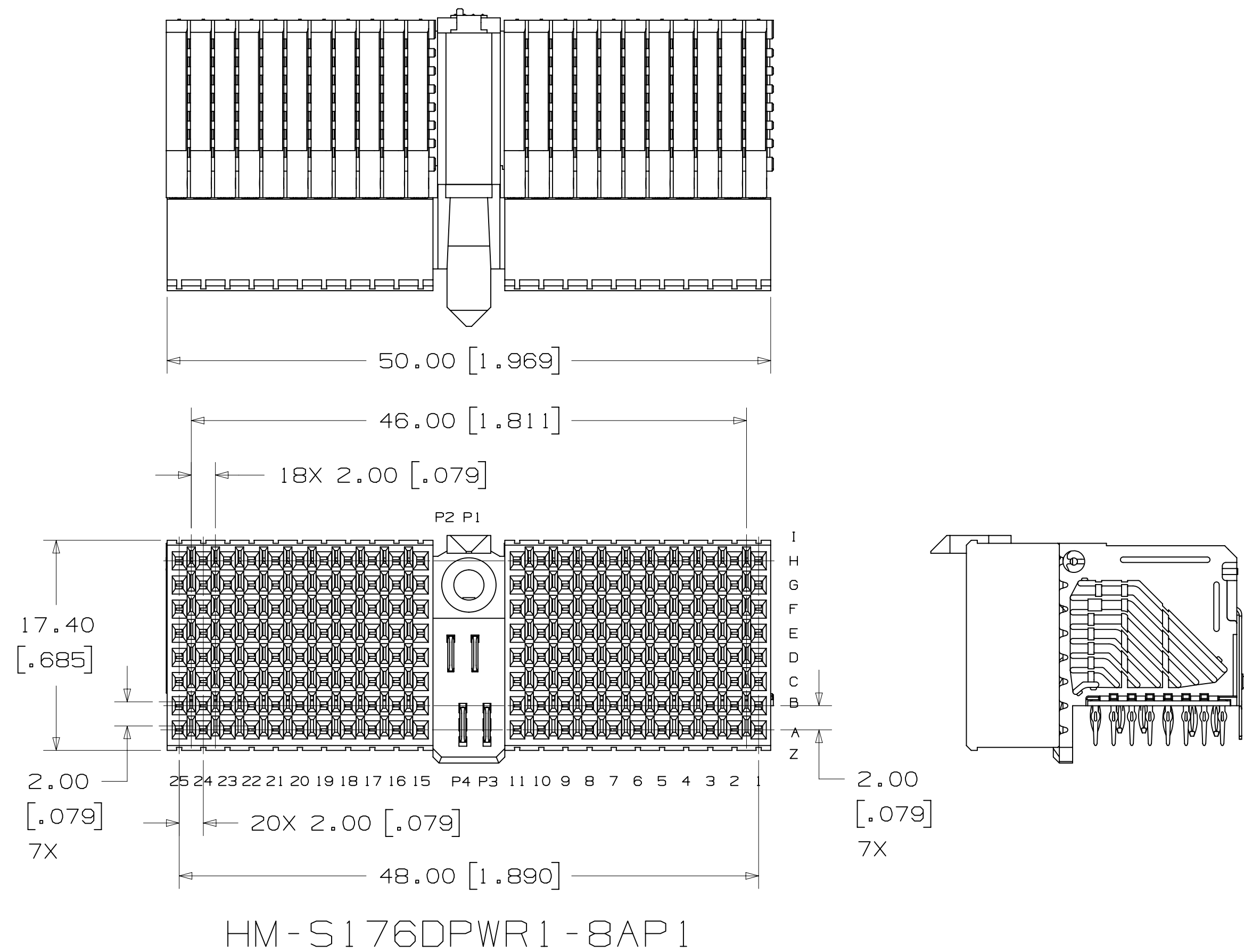

DESIGN REFERENCE	NEXT ASSEMBLY	REV	ECO	ISSUE DATE AND DESCRIPTION	DRFT	CHKD
		B	50345	OCT 07, 2013 REMOVED KR PLATING. REVISE RIA CALLOUT	JNC	TS
		A	39778	MAR 23, 2012 PRODUCTION RELEASE	JNC	TS
		CHKD	C	MAR 23, 2012		
		APPRV	T.	MAR 26, 2012		

DIVISION	Interconnect Solutions	DIVISION CODE	ISD
DO NOT SCALE DRAWING	SCALE 3/1	TOLERANCES EXCEPT AS NOTED	
THIRD ANGLE PROJECTION		INCHES	
INTERPRET PER ASME Y14.5 - 1994		MILLIMETERS	
MAX SURFACE ROUGHNESS		0 ±	
UNFINISHED SURFACES		.00 ± .01	
MARKED ONLY		.000 ± .005	
		.0000 ±	
		0 ±	
		.0 ± .3	
		.00 ± .13	
		.000 ±	
		ANGLES	

TITLE	HM PRESS-FIT 8-ROW SOCKET CONNECTORS, HM SERIES		
CAGE NUMBER	SIZE	DRAWING NO.	REV.
D		78-5100-2516-2	B
MODEL	DET	ISTS	YES X NO
			SHT 3 OF 4

78-5100-2516-2  
DRAWING NUMBER  
REV. 1  
B  
10/7/2013 2:10 PM UTC-05:00

3M™ HM PRESS-FIT SOCKET, 8-ROW, HM SERIES  
FOR HARD METRIC APPLICATIONS

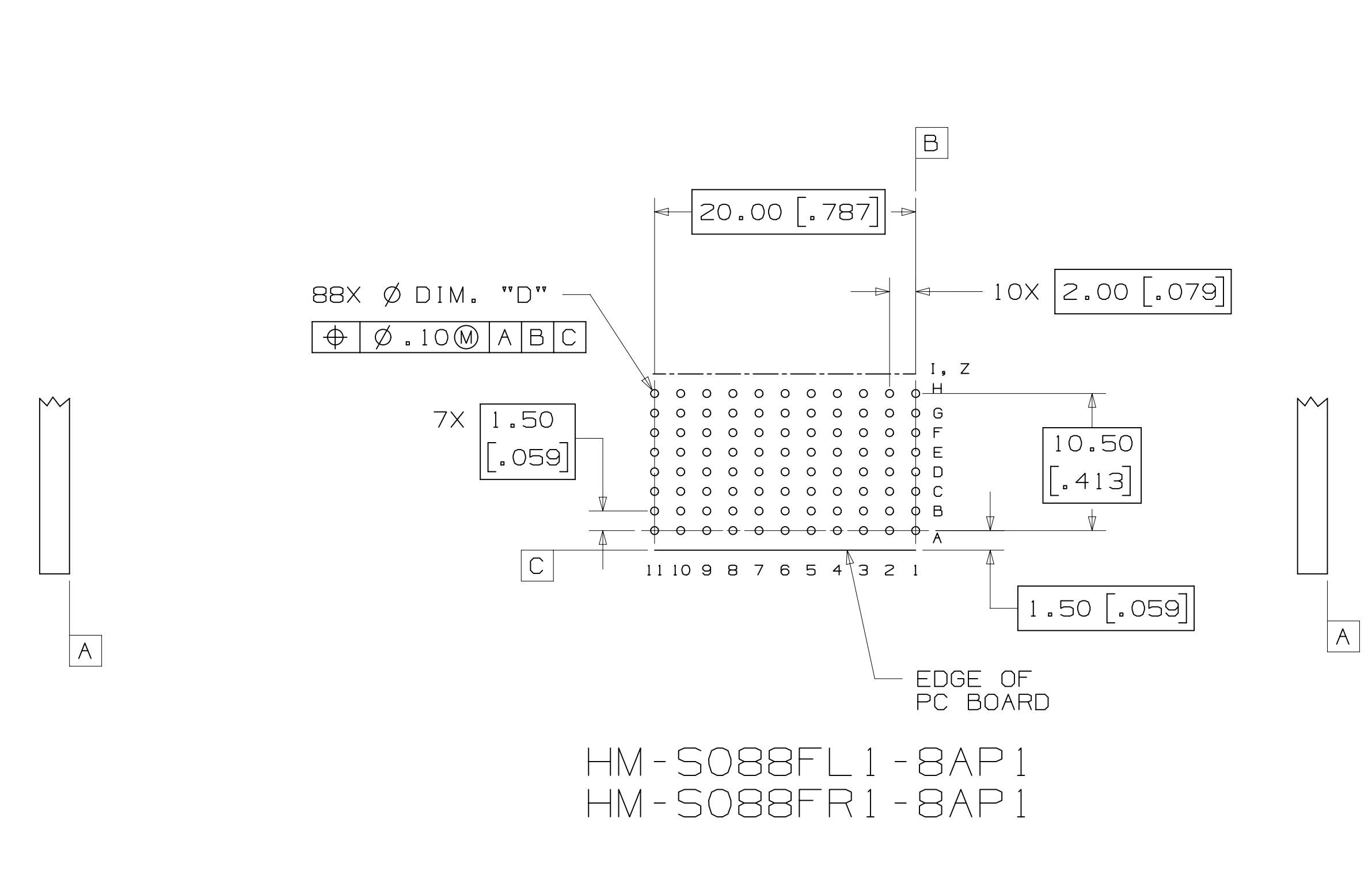
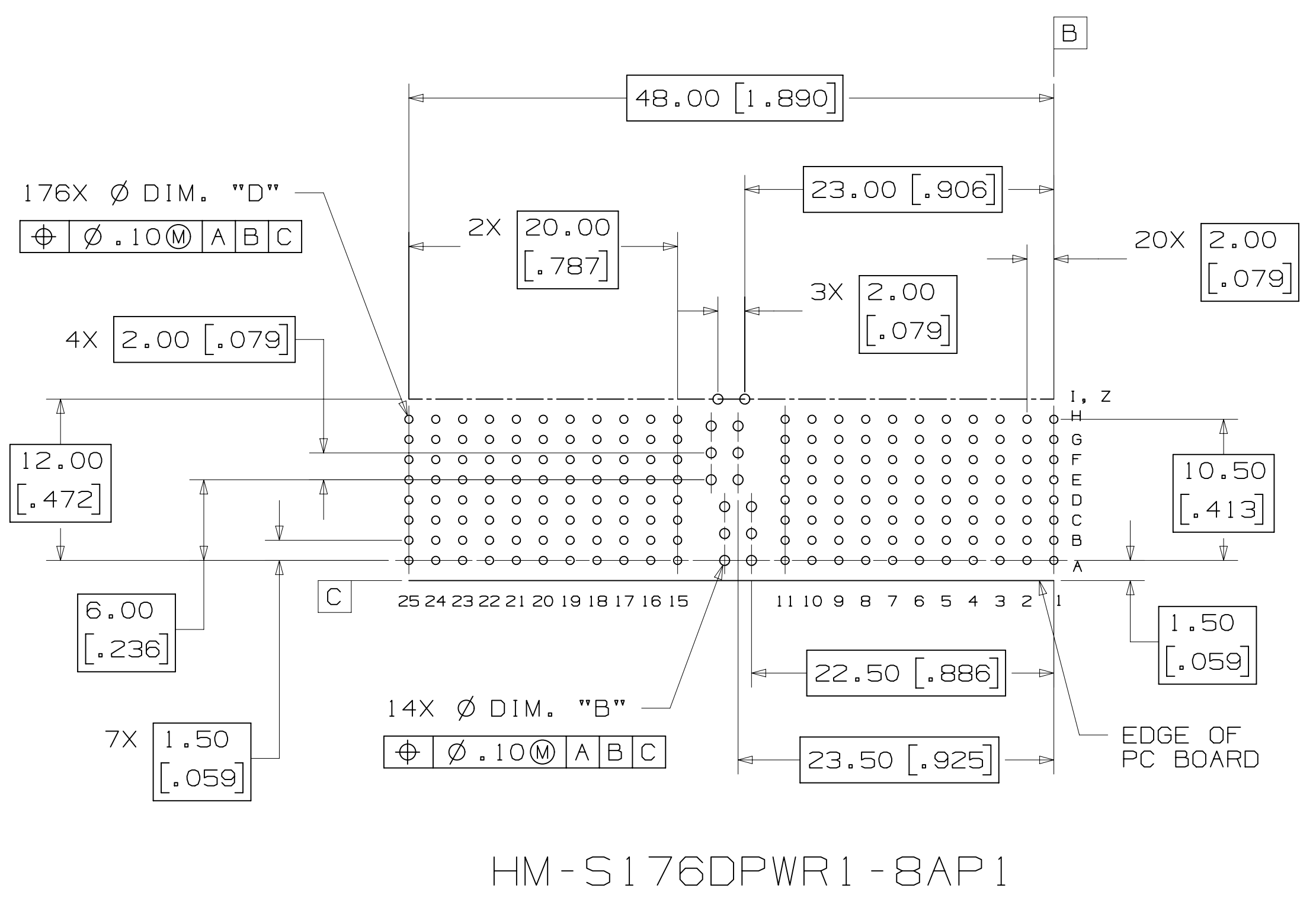
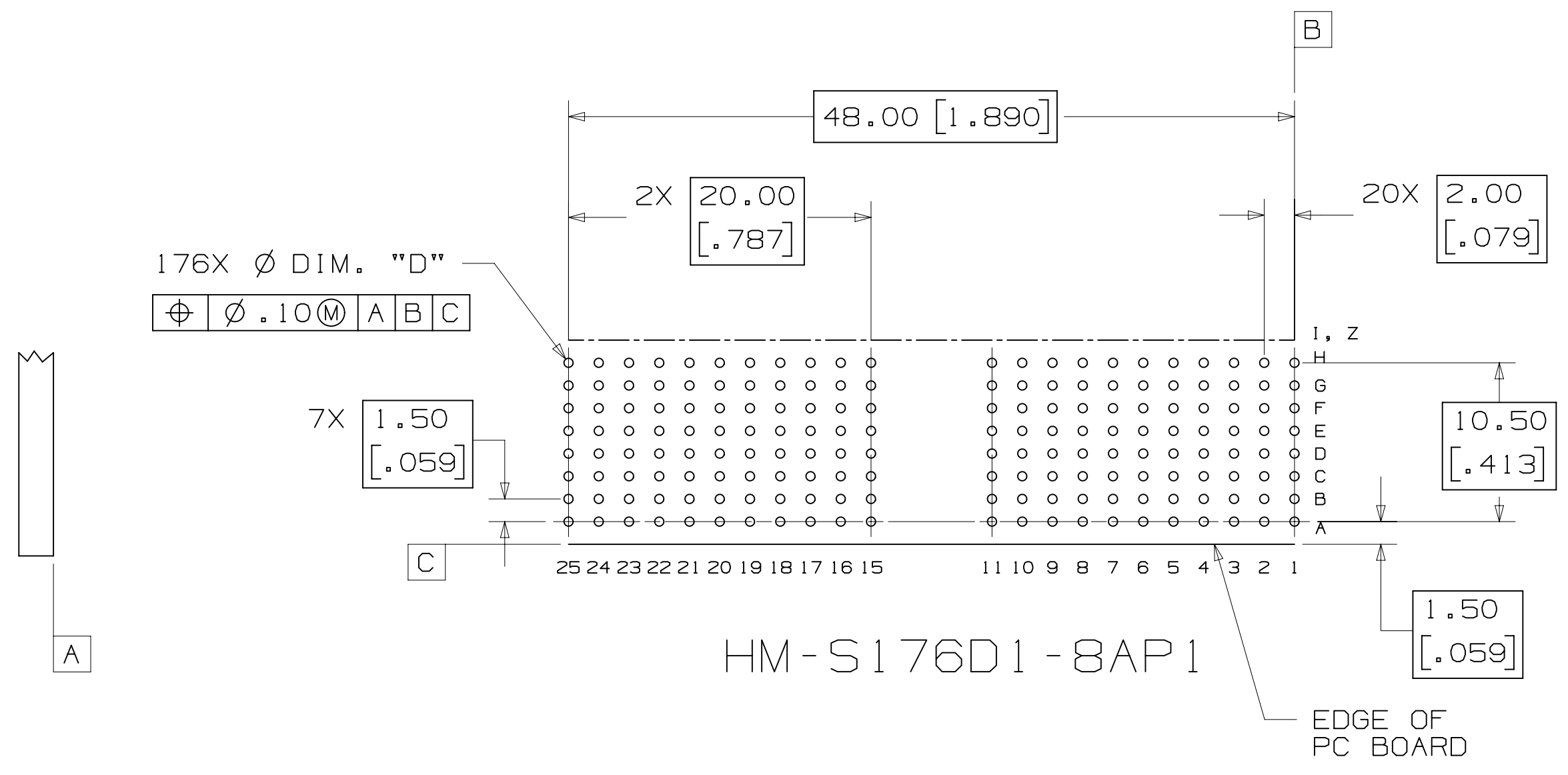
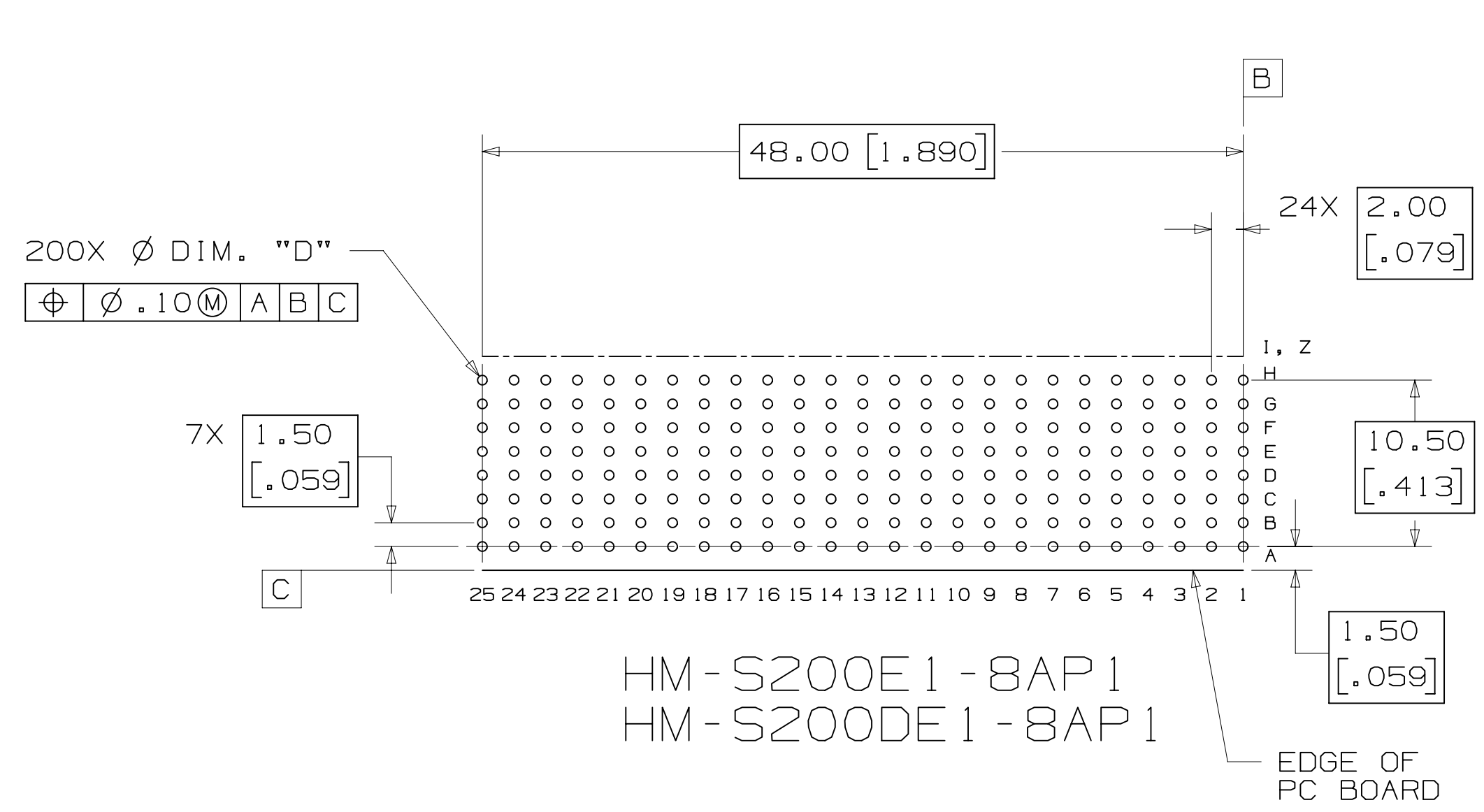

RECOMMENDED PCB MOUNTING HOLE PATTERN  
(VIEWED FROM COMPONENT SIDE)

HOLE PLATING TABLE				
HOLE	(FINISHED HOLE)	Cu THICKNESS	SnPb THICKNESS	DRILLED HOLE DIA.
DIM. "B"	.690-.790 [.0270-.0310]	.025-.045 [.0010-.0018]	.008-.018 [.0003-.0007]	.810-.860 [.0320-.0340]
DIM. "D"	.550-.650 [.0217-.0256]	.025-.045 [.0010-.0018]	.008-.018 [.0003-.0007]	.686-.727 [.0270-.0286]

DESIGN REFERENCE	NEXT ASSEMBLY	REV	ECO	ISSUE DATE AND DESCRIPTION	DRFT	CHKD
				MAR 23, 2012		
DIVISION		DIVISION CODE		DATE		
Interconnect Solutions		ISD		MAR 26, 2012		
DO NOT SCALE DRAWING	SCALE 3/1	TOLERANCES EXCEPT AS NOTED		DATE		
THIRD ANGLE PROJECTION		INCHES		DATE		
INTERPRET PER ASME Y14.5 - 1994		MILLIMETERS		DATE		
MAX SURFACE ROUGHNESS		INCHES		DATE		
SURFACES MARKED ONLY		MILLIMETERS		DATE		
		ANGLES		DATE		

REV	ECO	ISSUE DATE AND DESCRIPTION	DRFT	CHKD
A		MAR 23, 2012	JNC	TS
B	50345	OCT 07, 2013 REMOVED KR PLATING. REVISE RIA CALLOUT	JNC	TS

3M Center  
St. Paul, MN 55144

© 3M COPYRIGHT 2012  
This document and the information it contains are 3M property and may not be reproduced or further distributed without 3M permission, or used or disclosed other than for 3M authorized purposes. All rights reserved.

TITLE: HM PRESS-FIT 8-ROW SOCKET CONNECTORS, HM SERIES

CAGE NUMBER: D78-5100-2516-2

REV. B

MODEL: SHT 4 OF 4

78-5100-2516-2  
DRAWING NUMBER

B  
REVISION

10/7/2013 2:10 PM UTC-05:00  
Imaged: B.1