



Chipsmall Limited consists of a professional team with an average of over 10 year of expertise in the distribution of electronic components. Based in Hongkong, we have already established firm and mutual-benefit business relationships with customers from,Europe,America and south Asia,supplying obsolete and hard-to-find components to meet their specific needs.

With the principle of “Quality Parts,Customers Priority,Honest Operation,and Considerate Service”,our business mainly focus on the distribution of electronic components. Line cards we deal with include Microchip,ALPS,ROHM,Xilinx,Pulse,ON,Everlight and Freescale. Main products comprise IC,Modules,Potentiometer,IC Socket,Relay,Connector.Our parts cover such applications as commercial,industrial, and automotives areas.

We are looking forward to setting up business relationship with you and hope to provide you with the best service and solution. Let us make a better world for our industry!



Contact us

Tel: +86-755-8981 8866 Fax: +86-755-8427 6832

Email & Skype: info@chipsmall.com Web: www.chipsmall.com

Address: A1208, Overseas Decoration Building, #122 Zhenhua RD., Futian, Shenzhen, China



NOTES:

1. ROHS COMPLIANT
2. STORAGE TEMPERATURE: -50°C TO +125°C
3. COMPLIANCE TO J-STD:
 - A. J-STD-002: SOLDERABILITY AT 245°C REFLOW PROFILE
 - B. J-STD-020: LEVEL 1, NO MOISTURE SENSITIVE
 - C. J-STD-075: R7, 245°C MAXIMUM THROUGH REFLOW SOLDER
4. TO ORDER TAPE & REEL PACKAGING ADD A "T" SUFFIX TO THE PART NUMBER(i.e HXXXXXXNL BECOMES HXXXXXXNLT).
5. MEETS AEC-Q200 REQUIREMENTS

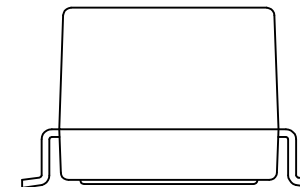
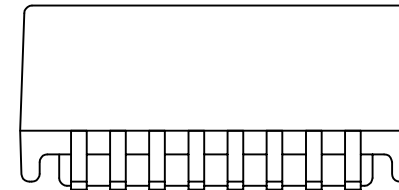
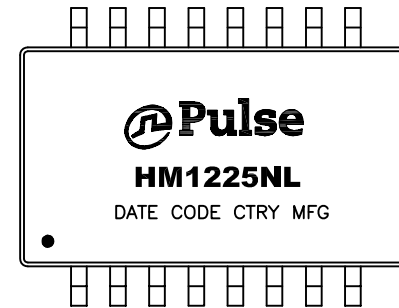

FINAL OUTLINE

© Copyright, 2016. Pulse Electronics Corp. All rights reserved. Pulse confidential & proprietary. (09/14/16)

PRODUCT DESCRIPTION	TLA DRAWING	PS DRAWING	SHEET	PART NO.	DATASHEET REV.
MDL,SIN,100D,1:1/1.5:1,SM,TU	HM1225NL-10	PS-2005.001-F	1 OF 3	HM1225NL	C

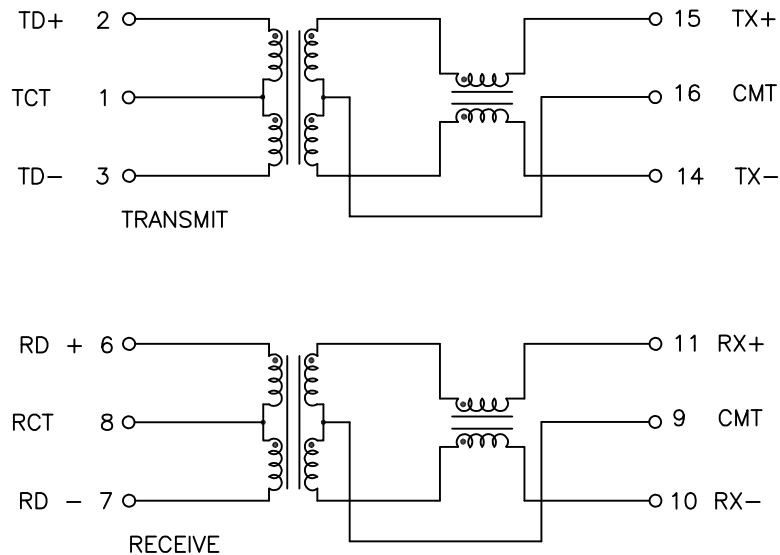

SCHEMATIC

ELECTRICAL CHARACTERISTICS AT +25°C UNLESS OTHERWISE SPECIFIED
(FOR REFERENCE ONLY. USED FOR CUSTOMER INFORMATION.)

PARAMETER	SPECIFICATIONS							
OPERATING TEMP	-40°C TO +95°C							
URNS RATIO	1 : 1 ±3%							
POLARITY	PER SCHEMATIC							
TRUNS RATIO	TRANSMIT				RECEIVE			
	1:1(±2%)				1.5:1(±2%)			
INSERTION LOSS	1-50 MHz				1-50 MHz			
	-1.0 dB MAX.				-1.5 dB MAX.			
RETURN LOSS Z _{OUT} = 100 OHMS	0.5~40 MHz	60 MHz	80 MHz	0.5MHz	40 MHz	60 MHz	80 MHz	
	-18 dB MIN.	-14.5 dB MIN.	-12 dB MIN.	-18 dB MIN.	-10 dB MIN.	-8 dB MIN.	-6 dB MIN.	
CROSSTALK	30 MHz		60 MHz		100 MHz			
	-45 dB		-35 dB		-30 dB			
OCL	200 uH MIN		MEASURED AT 100 KHz, 100 mVRMS, AT +25 °C					
	100 uH MIN		MEASURED AT 100 KHz, 100 mVRMS, AT -40 °C					
C _{ww}	100 uH MIN		MEASURED AT 100 KHz, 100 mVRMS, AT +95 °C					
	18 pF MAX		MEASURED AT 100 KHz, 100 mVRMS					
ISOLATION (INPUT - OUTPUT)	1650 VRMS, 6 SECONDS MAX							

© Copyright, 2016. Pulse Electronics Corp. All rights reserved. Pulse confidential & proprietary. (09/14/16)

PRODUCT DESCRIPTION	TLA DRAWING	PS DRAWING	SHEET	PART NO.	DATASHEET REV.
MDL,SIN,100D,1:1/1.5:1,SM,TU	HM1225NL-10	PS-2005.001-F	2 OF 3	HM1225NL	C

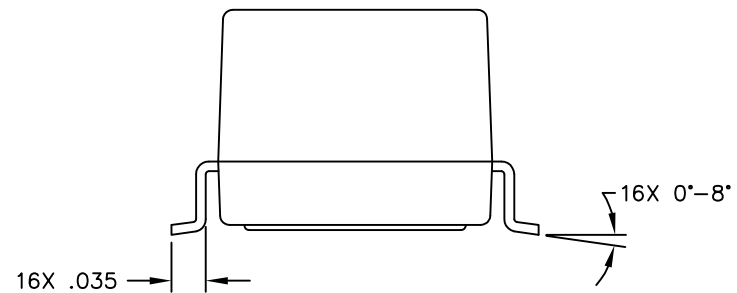
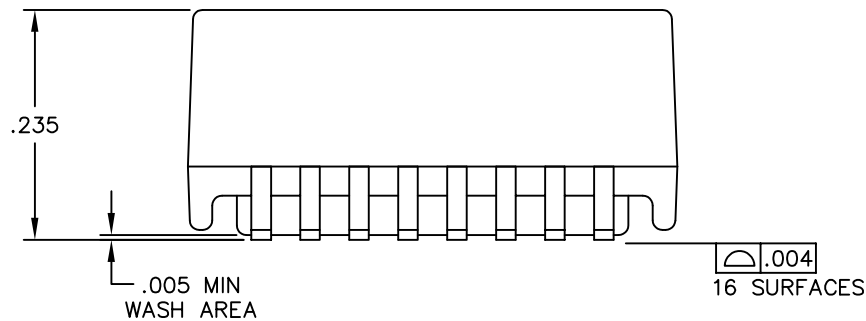
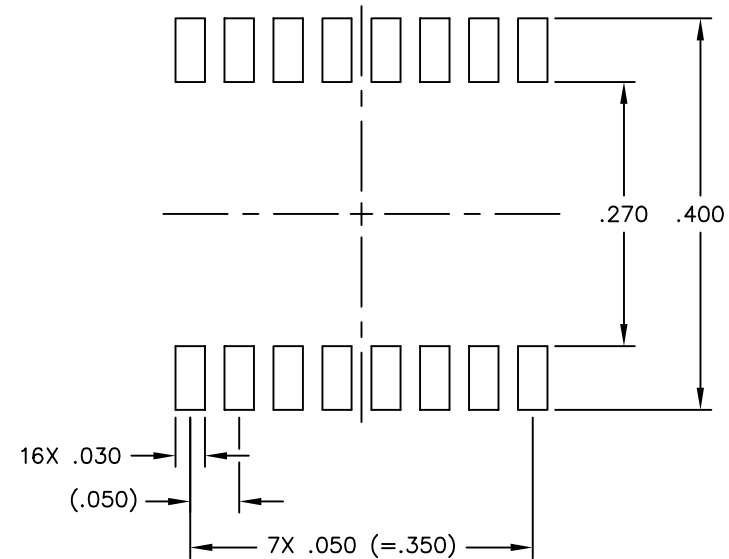
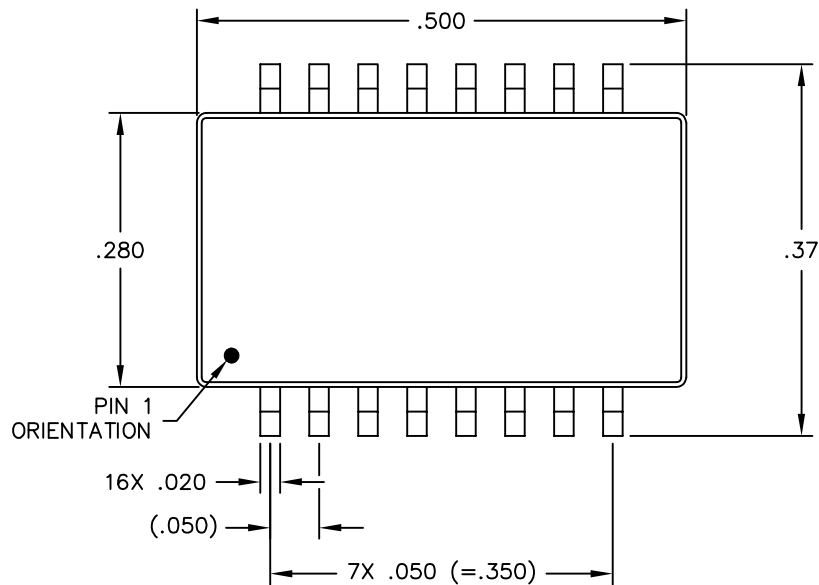

DIMENSIONS ARE IN INCHES WITH THE FOLLOWING TOLERANCES:

.XX= ±.01
.XXX= ±.005

© Copyright, 2016. Pulse Electronics Corp. All rights reserved. Pulse confidential & proprietary. (09/14/16)

PRODUCT DESCRIPTION	TLA DRAWING	PS DRAWING	SHEET	PART NO.	DATASHEET REV.
MDL,SIN,100D,1:1/1.5:1,SM,TU	HM1225NL-10	PS-2005.001-F	3 OF 3	HM1225NL	C