



Chipsmall Limited consists of a professional team with an average of over 10 year of expertise in the distribution of electronic components. Based in Hongkong, we have already established firm and mutual-benefit business relationships with customers from,Europe,America and south Asia,supplying obsolete and hard-to-find components to meet their specific needs.

With the principle of "Quality Parts,Customers Priority,Honest Operation,and Considerate Service",our business mainly focus on the distribution of electronic components. Line cards we deal with include Microchip,ALPS,ROHM,Xilinx,Pulse,ON,Everlight and Freescale. Main products comprise IC,Modules,Potentiometer,IC Socket,Relay,Connector.Our parts cover such applications as commercial,industrial, and automotives areas.

We are looking forward to setting up business relationship with you and hope to provide you with the best service and solution. Let us make a better world for our industry!



Contact us

Tel: +86-755-8981 8866 Fax: +86-755-8427 6832

Email & Skype: info@chipsmall.com Web: www.chipsmall.com

Address: A1208, Overseas Decoration Building, #122 Zhenhua RD., Futian, Shenzhen, China



NOTES: UNLESS OTHERWISE SPECIFIED

1.

NOTICE:	THIS IS A RoHS COMPLIANT COMPONENT/PRODUCT. ALL ENGINEERING CHANGES MUST HAVE PRIOR APPROVAL BY THE DESIGN CENTER.
RoHS	

2. SOLDERABILITY: CONFORMS TO ANSI/J-STD-002, IPC/EIA J-STD-003A.
3. OPERATING TEMPERATURE: -40°C TO +125°C
4. STORAGE TEMPERATURE: -50°C TO +125°C
5. JEDEC MOISTURE: LEVEL 1.
6. AEC-Q200 QUALIFIED
7. TO ORDER TAPE & REEL PACKAGING ADD A "T" SUFFIX TO THE PART NUMBER (ie. HM2103NL BECOMES HM2103NLT)
8. UNLESS OTHERWISE SPECIFIED, ALL DIMENSIONS ARE IN INCHES. TOLERANCES ARE:

DECIMALS

.XX ±.01

.XXX ±.005

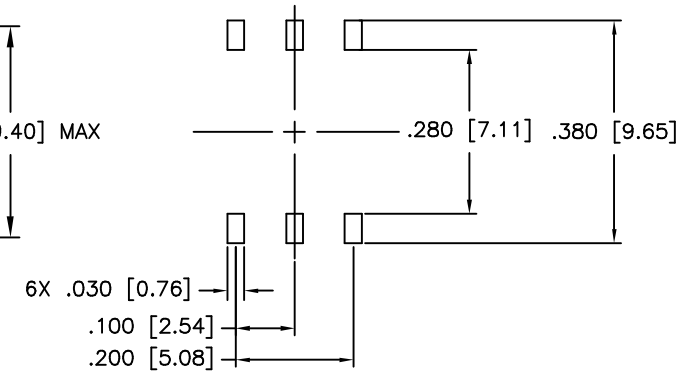
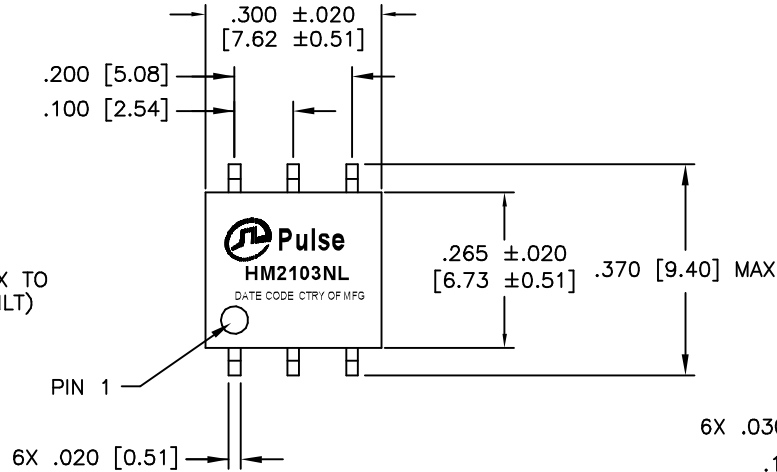

SUGGESTED LAND PATTERN

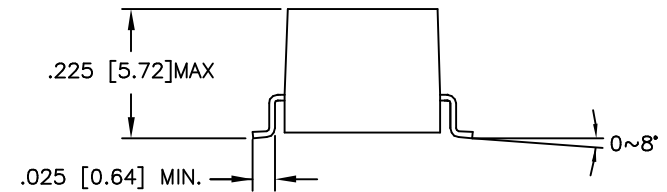
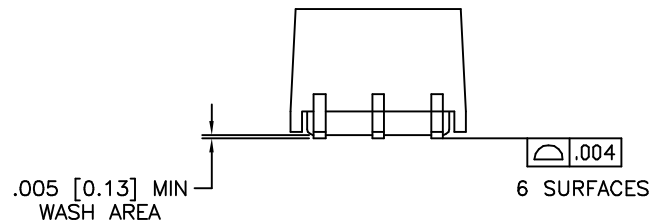

© Copyright, 2017. Pulse Electronics Corp. All rights reserved. Pulse confidential & proprietary. (09/13/17)

PRODUCT DESCRIPTION	TLA DRAWING	PS DRAWING	SHEET	PART NO.	DATASHEET REV.
TRANSFORMER/CMC,4.3kVDC ISO,SGL,SMT	HM2103NL-10	PS-01528.001-A	1 OF 2	HM2103NL	N

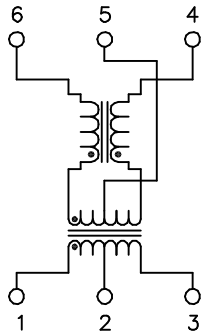
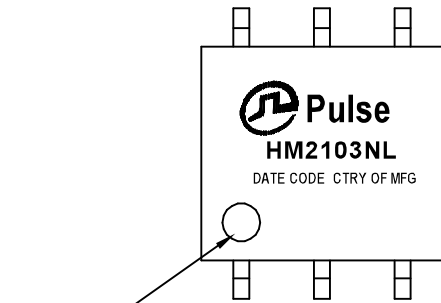

SCHEMATIC

ELECTRICAL CHARACTERISTICS AT +25°C UNLESS OTHER SPECIFIED

PARAMETER	SPECIFICATIONS	
QUALIFICATION	PER AEC-Q200	
DESIGN CONSTRUCTION	FUNCTIONAL INSULATION	
CREEPAGE DISTANCE	> 5mm	
OPERATING TEMPERATURE	-40°C TO 125 °C	
TURNS RATIO	1.00 ± 2%	
POLARITY	PER SCHEMATIC	
DC RESISTANCE	TRANSFORMER SIDE	CM CHOKE SIDE
	0.45 OHMS MAX	0.85 OHMS MAX
INDUCTANCE (OCL) AT 100 kHz, 100 mV (-40°C TO +125°C)	150 uH MIN, 450 uH MAX	
LEAKAGE INDUCTANCE	0.50 uH MAX @ 100 kHz	
INSERTION LOSS	0.25 dB MAX @ 4 MHz	
RETURN LOSS (Z OUT = 100 OHM ±1%)	20 dB MIN @ 4 MHz	
COMMON MODE REJECTION RATIO	1-10 MHz	10-1000 MHz
	-35 dB MIN	-20 dB MIN
INPUT - OUTPUT ISOLATION	4300 VDC FOR 60 SECONDS WITH 1.0 mA MAX OF LEAKAGE CURRENT	
INSULATION RESISTANCE	400 MEGAOHMS MINIMUM	
WORKING VOLTAGE	1000 VDC FOR 15 YEARS	

© Copyright, 2017. Pulse Electronics Corp. All rights reserved. Pulse confidential & proprietary. (09/13/17)

PRODUCT DESCRIPTION	TLA DRAWING	PS DRAWING	SHEET	PART NO.	DATASHEET REV.
TRANSFORMER/CMC,4.3kVDC ISO,SGL,SMT	HM2103NL-10	PS-01528.001-A	2 OF 2	HM2103NL	N