



Chipsmall Limited consists of a professional team with an average of over 10 year of expertise in the distribution of electronic components. Based in Hongkong, we have already established firm and mutual-benefit business relationships with customers from,Europe,America and south Asia,supplying obsolete and hard-to-find components to meet their specific needs.

With the principle of “Quality Parts,Customers Priority,Honest Operation,and Considerate Service”,our business mainly focus on the distribution of electronic components. Line cards we deal with include Microchip,ALPS,ROHM,Xilinx,Pulse,ON,Everlight and Freescale. Main products comprise IC,Modules,Potentiometer,IC Socket,Relay,Connector.Our parts cover such applications as commercial,industrial, and automotives areas.

We are looking forward to setting up business relationship with you and hope to provide you with the best service and solution. Let us make a better world for our industry!



Contact us

Tel: +86-755-8981 8866 Fax: +86-755-8427 6832

Email & Skype: info@chipsmall.com Web: www.chipsmall.com

Address: A1208, Overseas Decoration Building, #122 Zhenhua RD., Futian, Shenzhen, China



GEN. ST.	01	02	03	04	05	06	07	08	0D	50	60	70	80	90																	
INT. ST.	10	11	12	13	14	18	20	31	32	33	34	38	39	40	42	43	44	45	46	48	56	70	72	73	75	76	81	82	83	84	88

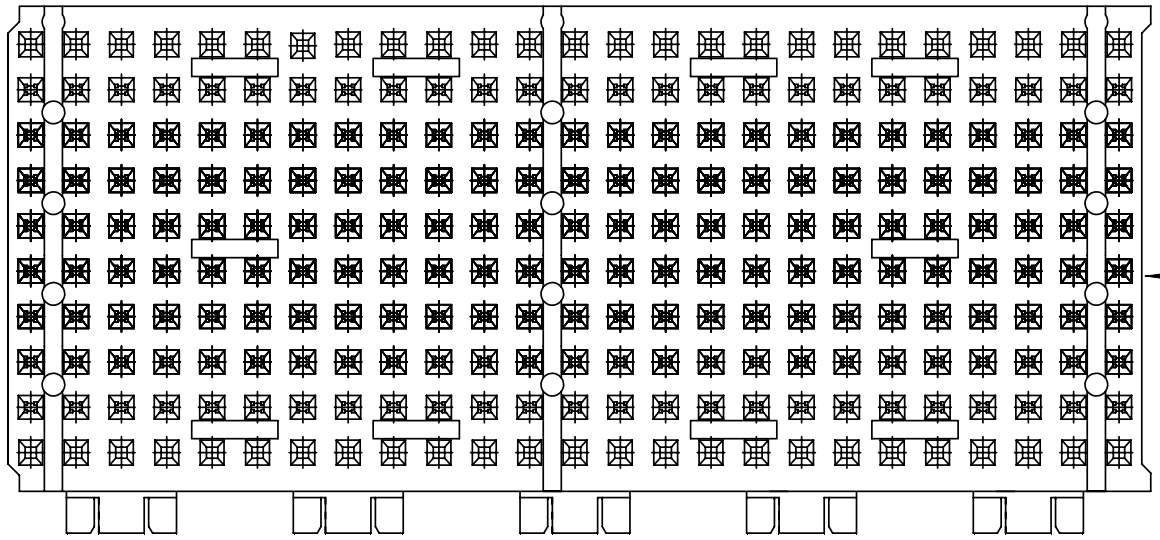

REV.	DATE	DESCRIPTION	BY	C'K'D'
A	2012-10-20	112-0057	AKA	BKP

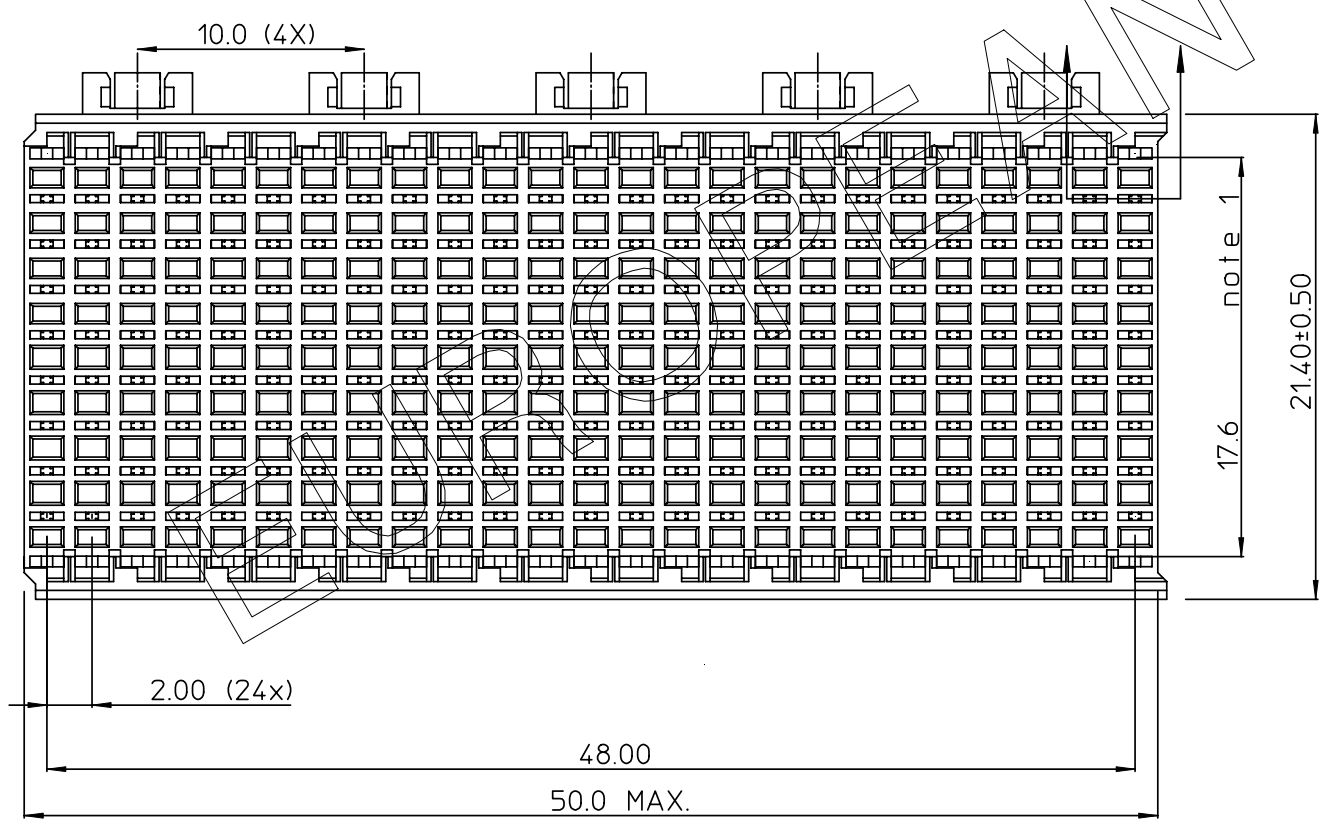
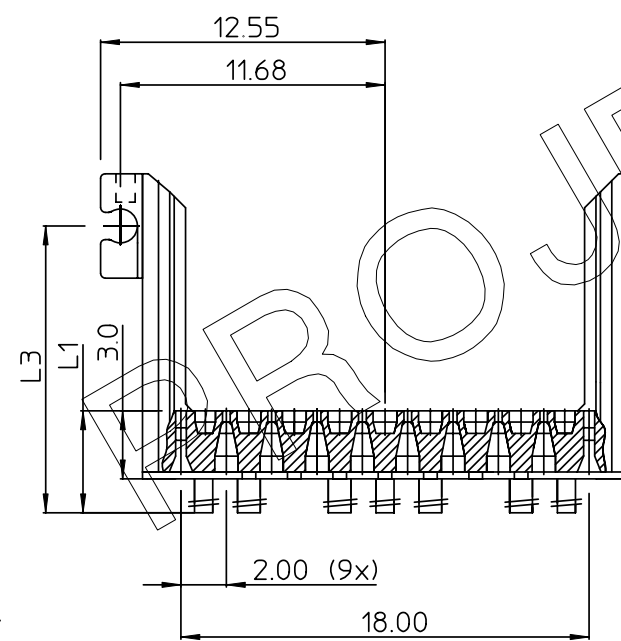
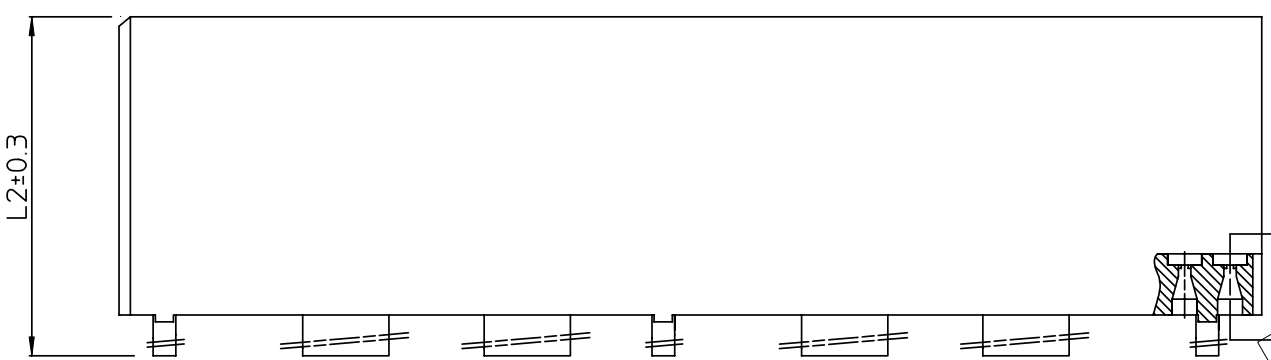

- NOTES:
1. MEASURED AT THE BOTTOM
 2. MATERIAL: GLASSREINFORCED POLYESTER UL94 - V0
 3. THIS PRODUCT MEETS EUROPEAN UNION DIRECTIVES AND OTHER COUNTRY REGULATIONS AS DESCRIBED IN GS-47-0004.
 4. PARTS WITH AND WITHOUT SUFFIX LF TO THE PRODUCT PART NUMBER ARE IDENTICAL IN FORM, FIT AND FUNCTION. LF SUFFIX IS ADDED TO THE PART NUMBER OF THIS PRODUCT TO HAVE UNIFORM IDENTIFICATION OF ALL RoHS COMPATIBLE PRODUCTS.



PART NUMBER	L1	L2	L3
HM2H8 1P1LF	3.0	13.45	11.15
HM2H8 1P109LF	3.9	14.35	12.05
HM2H8 1P111LF	4.1	14.55	12.25
HM2H8 1P115LF	4.5	14.95	12.65
HM2H8 1P117LF	4.7	15.15	12.85
HM2H8 1P119LF	4.9	15.35	13.05
HM2H8 1P122LF	5.2	15.65	13.35
HM2H8 1P130LF	6.0	16.45	14.15

1DEC ±0.2 2DEC ±0.1 ANGLES ±1° WE RESERVE THE RIGHT TO CHANGE DIMENSIONS OR REQUIREMENTS WITHOUT PRIOR NOTICE. ALL DIMENSIONS IN MM	APPR.	DATE	SIGN.	MPACS 8+2R SHROUD TYPE E WITH LOCKING
	DRAFT	2012-10-20	AKA	CAT. No. HM2H8 1P1--LF
	CHECKED	2012-10-20	AB	
REFERENCES  	PROD. MGR.	2012-10-20	AB	 www.fciconnect.com
	PR. ENG. MGR.	2012-10-20	BKP	
	PR. MGT. MGR.			BS,C ,202311,015 DRAWING No. CUSTOMER DRAWING REVISION A

THIS IS OUR EXCLUSIVE PROPERTY. IT IS NOT TO BE COPIED, REPRINTED OR DISCLOSED TO A THIRD PARTY, NOR USED FOR MANUFACTURING WITHOUT OUR WRITTEN CONSENT, AND HAS TO BE RETURNED TO US IN CASE OF NO USAGE

DIT IS ONZE EIGENDOM EN MAG NOCH NAGEMAAKT. HERDRUKT, OVERGEMAAKT AAN DERDEN, NOCH VOOR FABRIKATIE GEBRUIKT WORDEN, ZONDER ONZE SCHRIFTELIJKE TOELATING. BIJ NIET GEBRUIK IS TERUGZENDING VERPLICHT.