



Chipsmall Limited consists of a professional team with an average of over 10 year of expertise in the distribution of electronic components. Based in Hongkong, we have already established firm and mutual-benefit business relationships with customers from,Europe,America and south Asia,supplying obsolete and hard-to-find components to meet their specific needs.

With the principle of “Quality Parts,Customers Priority,Honest Operation,and Considerate Service”,our business mainly focus on the distribution of electronic components. Line cards we deal with include Microchip,ALPS,ROHM,Xilinx,Pulse,ON,Everlight and Freescale. Main products comprise IC,Modules,Potentiometer,IC Socket,Relay,Connector.Our parts cover such applications as commercial,industrial, and automotives areas.

We are looking forward to setting up business relationship with you and hope to provide you with the best service and solution. Let us make a better world for our industry!



## Contact us

Tel: +86-755-8981 8866 Fax: +86-755-8427 6832

Email & Skype: info@chipsmall.com Web: www.chipsmall.com

Address: A1208, Overseas Decoration Building, #122 Zhenhua RD., Futian, Shenzhen, China



GEN. ST.	01	02	03	04	05	06	07	08	0D	50	60	70	80	90																	
INT. ST.	10	11	12	13	14	18	20	31	32	33	34	38	39	40	42	43	44	45	46	48	56	70	72	73	75	76	81	82	83	84	88

REV.	DATE	DESCRIPTION	BY	C 'K' D'
A	2003-03-31	CONVERSION REVISION 0A	KN	
B	2008-12-06	108-0165	ALEX B	BKP

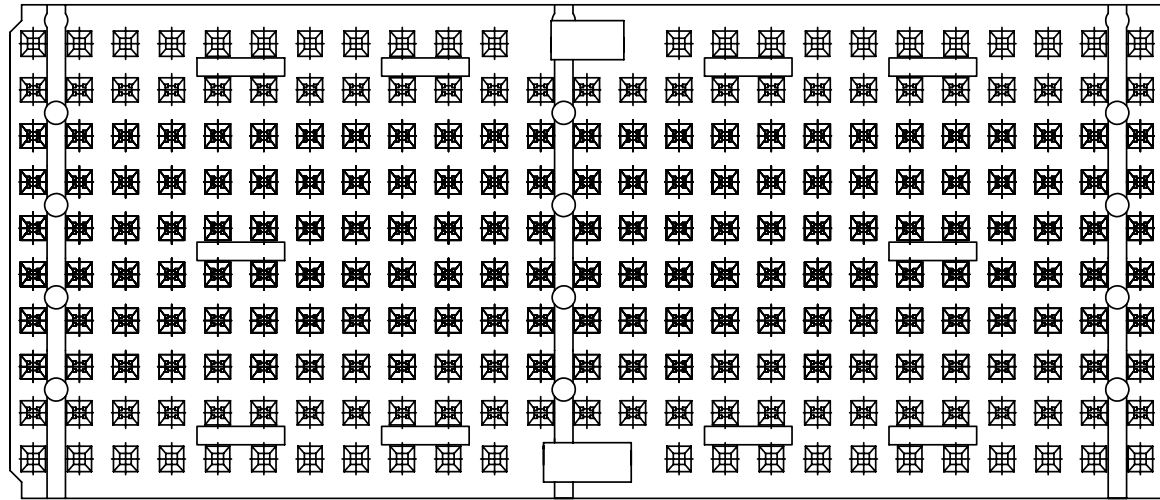

ABRIDGED CAT No MARKED



RoHS COMPATIBLE  
(DIGIT 11 & 12)

HM2H95P1--LF

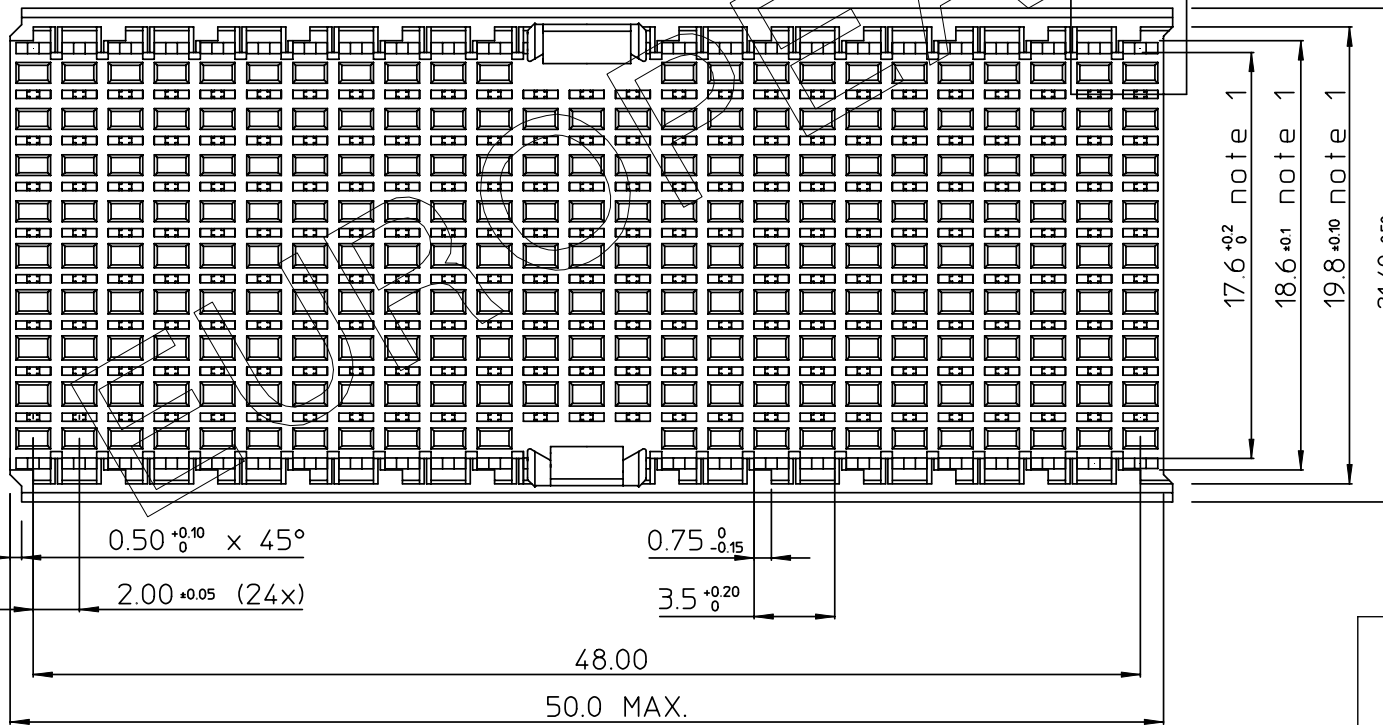
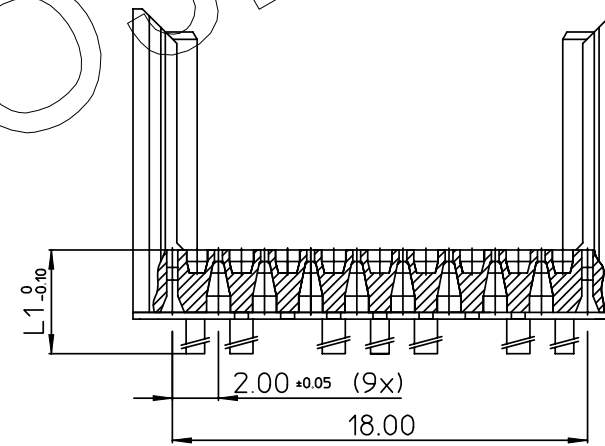
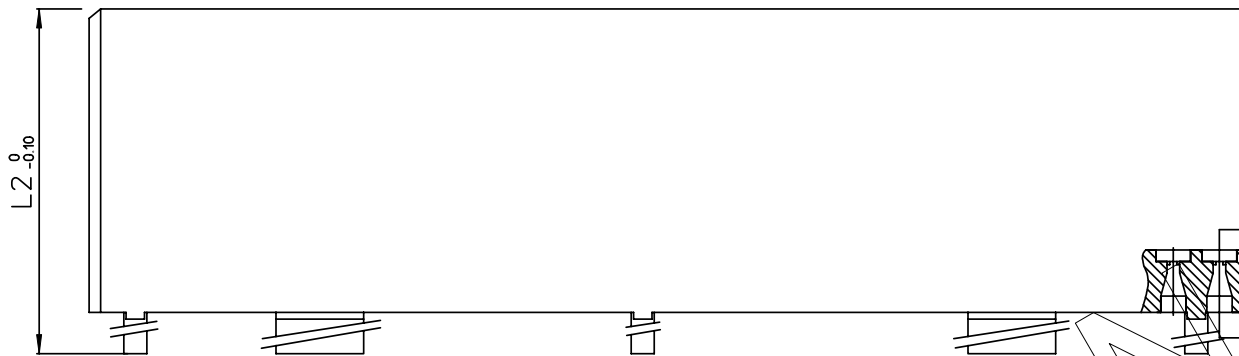
- NOTES:
1. MEASURED AT THE BOTTOM
  2. MATERIAL: GLASS REINFORCED POLYESTER UL94-V0
  3. THE "LF" PRODUCT MEETS EUROPEAN UNION DIRECTIVES AND OTHER COUNTRY REGULATIONS AS DESCRIBED IN GS-22-008.
  4. PARTS WITH AND WITHOUT SUFFIX LF TO THE PRODUCT PART NUMBER ARE IDENTICAL IN FORM, FIT AND FUNCTION. LF SUFFIX IS ADDED TO THE PART NUMBER OF THIS PRODUCT TO HAVE UNIFORM IDENTIFICATION OF ALL ROHS COMPATIBLE PRODUCTS.



PART NUMBER	L1	L2	
HM2H95P1LF	3.0	13.45	AVAILABLE
HM2H95P109LF	3.9	14.35	AVAILABLE
HM2H95P111LF	4.1	14.55	AVAILABLE
HM2H95P115LF	4.5	14.95	AVAILABLE
HM2H95P117LF	4.7	15.15	AVAILABLE
HM2H95P119LF	4.9	15.35	AVAILABLE
HM2H95P122LF	5.2	15.65	AVAILABLE

1DEC ±0.2 2DEC ±0.1 ANGLES ±1°	<b>APPR.</b>	<b>DATE</b>	<b>SIGN.</b>	MPACS 8+2R SHROUD TYPE DE
	DRAFT	2002-03-11	M.Fret	<b>CAT. No.</b> HM2H95P1--LF
WE RESERVE THE RIGHT TO CHANGE DIMENSIONS OR REQUIREMENTS WITHOUT PRIOR NOTICE.	CHECKED			 www.fciconnect.com
	PROD. MGR.			
	ALL DIMENSIONS IN MM	PR. ENG. MGR.		
	PR. MGT. MGR.			
	<b>REFERENCES</b>			
 				BS,C ,202311,013 DRAWING No. CUSTOMER DRAWING REVISION B

THIS IS OUR EXCLUSIVE PROPERTY. IT IS NOT TO BE COPIED, REPRINTED OR DISCLOSED TO A THIRD PARTY, NOR USED FOR MANUFACTURING WITHOUT OUR WRITTEN CONSENT, AND HAS TO BE RETURNED TO US IN CASE OF NO USAGE

DIT IS ONZE EIGENDOM EN MAG NOCH NAGEMAAKT, HERDRUKT, OVERGEMAAKT AAN DERDEN, NOCH VOOR FABRIKATIE GEBRUIKT WORDEN, ZONDER ONZE SCHRIFTELIJKE TOELATING. BIJ NIET GEBRUIK IS TERUGZENDING VERPLICHT.