



Chipsmall Limited consists of a professional team with an average of over 10 year of expertise in the distribution of electronic components. Based in Hongkong, we have already established firm and mutual-benefit business relationships with customers from,Europe,America and south Asia,supplying obsolete and hard-to-find components to meet their specific needs.

With the principle of “Quality Parts,Customers Priority,Honest Operation,and Considerate Service”,our business mainly focus on the distribution of electronic components. Line cards we deal with include Microchip,ALPS,ROHM,Xilinx,Pulse,ON,Everlight and Freescale. Main products comprise IC,Modules,Potentiometer,IC Socket,Relay,Connector.Our parts cover such applications as commercial,industrial, and automotives areas.

We are looking forward to setting up business relationship with you and hope to provide you with the best service and solution. Let us make a better world for our industry!



Contact us

Tel: +86-755-8981 8866 Fax: +86-755-8427 6832

Email & Skype: info@chipsmall.com Web: www.chipsmall.com

Address: A1208, Overseas Decoration Building, #122 Zhenhua RD., Futian, Shenzhen, China



GaAs HEMT MMIC DRIVER AMPLIFIER, 17.5 - 41.0 GHz

Typical Applications

This HMC-AUH256 is ideal for:

- Point-to-Point Radios
- Point-to-Multi-Point Radios
- VSAT
- SATCOM

Features

- Gain: 21 dB
- P1dB Output Power: +20 dBm
- Wideband Performance: 17.5 to 40 GHz
- Supply Voltage: +5V @ 295 mA
- Small Chip Size: 2.1 x 0.92 x 0.1 mm

Functional Diagram

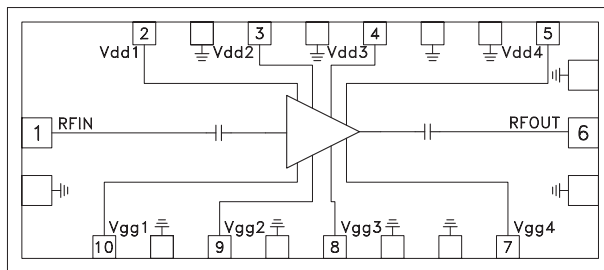

General Description

The HMC-AUH256 is a GaAs MMIC HEMT four stage Driver Amplifier which covers the frequency range of 17.5 to 40 GHz. The chip can easily be integrated into Multi-Chip-Modules (MCMs) due to its small (1.93 mm²) size. The HMC-AUH256 offers 21 dB of gain and +20 dBm output power at 1 dB compression from a bias supply of +5V @ 295 mA. The HMC-AUH256 may also be used as a frequency doubler. Detail bias condition to achieve doubler operation.

Electrical Specifications ^[1], T_A = +25°C

V_{dd1} = V_{dd2} = V_{dd3} = V_{dd4} = 5V, I_{dd1} + I_{dd2} + I_{dd3} + I_{dd4} = 295mA ^[2]

Parameter	Min.	Typ.	Max.	Units
Frequency Range	17.5 - 41			GHz
Gain		21		dB
Input Return Loss		8		dB
Output Return Loss	20 - 30 GHz	15		dB
	30 - 45 GHz	8		dB
Output Power for 1 dB Compression		20		dBm
Saturated Output Power		23		dBm
Output IP3		27		dBm
Supply Current (I _{dd1} + I _{dd2} + I _{dd3} + I _{dd4})		295		mA

[1] Unless otherwise indicated, all measurements are from probed die

[2] Adjust V_{gg1} = V_{gg2} = V_{gg3} = V_{gg4} between -1V to +0.3V (Typ. -0.3V) to achieve I_{dd1} = 50 mA, I_{dd2} = 50 mA, I_{dd3} = 75 mA, I_{dd4} = 120 mA

**GaAs HEMT MMIC DRIVER
AMPLIFIER, 17.5 - 41.0 GHz**

Linear Gain vs. Frequency

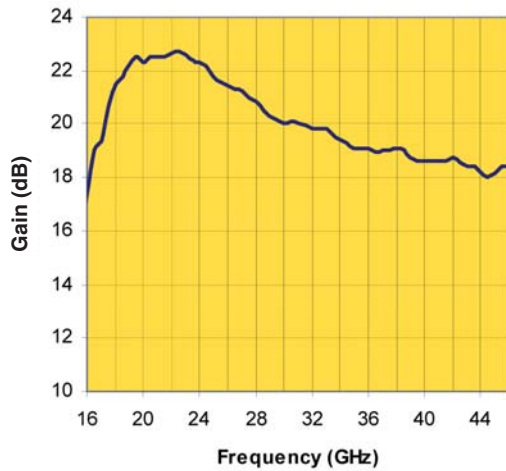

Fixtured Pout vs. Frequency

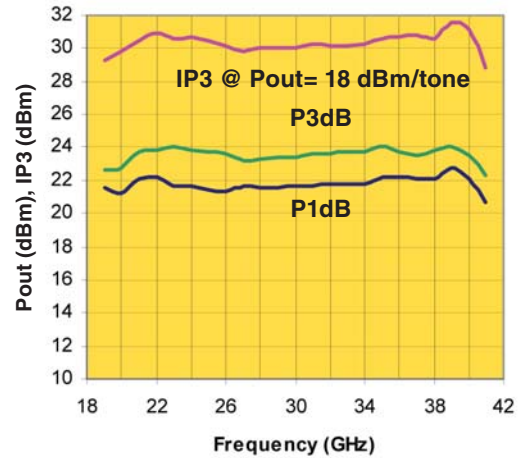

Input Return Loss vs. Frequency

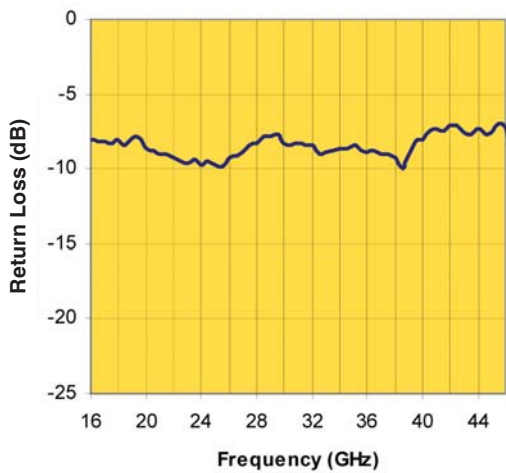

Output Return Loss vs. Frequency

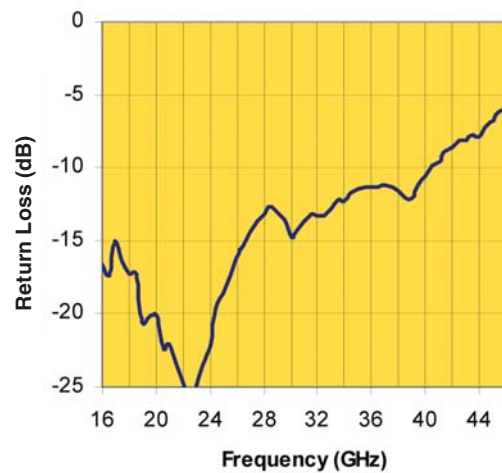

Information furnished by Analog Devices is believed to be accurate and reliable. However, no responsibility is assumed by Analog Devices for its use, nor for any infringements of patents or other rights of third parties that may result from its use. Specifications subject to change without notice. No license is granted by implication or otherwise under any patent or patent rights of Analog Devices. Trademarks and registered trademarks are the property of their respective owners.

For price, delivery, and to place orders: Analog Devices, Inc., One Technology Way, P.O. Box 9106, Norwood, MA 02062-9106 Phone: 781-329-4700 • Order online at www.analog.com Application Support: Phone: 1-800-ANALOG-D

GaAs HEMT MMIC DRIVER AMPLIFIER, 17.5 - 41.0 GHz

x2 Pout vs. Frequency (vs Pad)

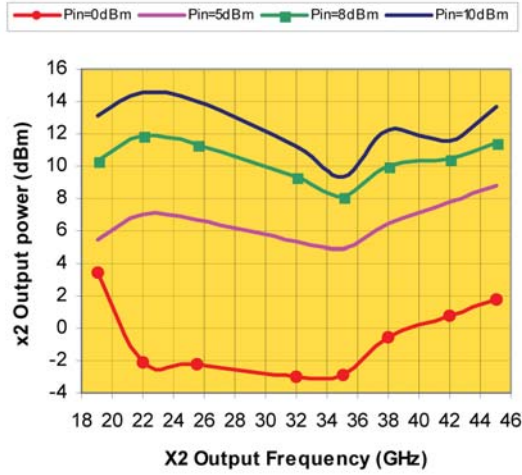

Fixture Pout vs. Frequency @ Pin= 8 dBm

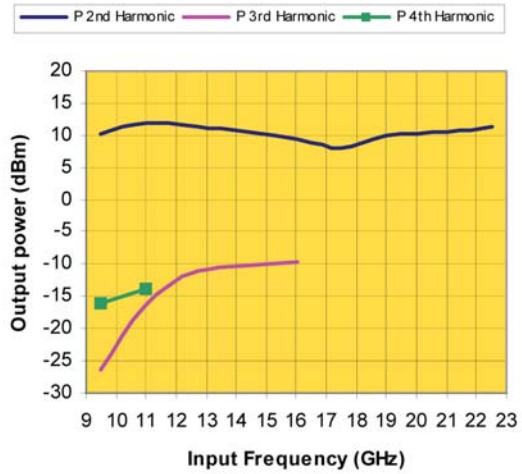

Fixture Pout vs. Frequency @ Pin= 10 dBm

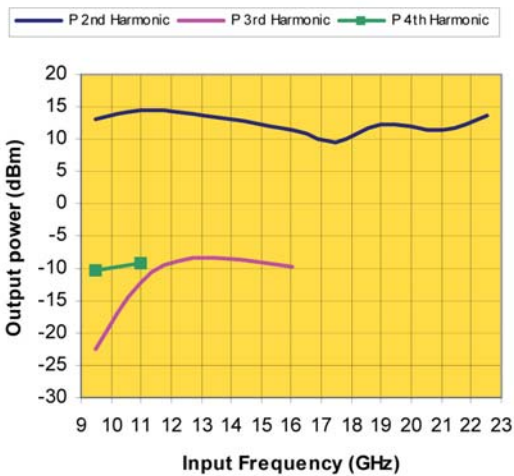

Absolute Maximum Ratings

Drain Bias Voltage	+5.5 Vdc
RF Input Power	15 dBm
Drain Bias Current (Idd1, Idd2)	62 mA
Drain Bias Current (Idd3)	93 mA
Drain Bias Current (Idd4)	150 mA
Gate Bias Voltage	-1 to +0.3 Vdc
Channel Temperature	180 °C
Thermal Resistance (channel to die bottom)	77.5 °C/W
Storage Temperature	-65 to +150 °C



**ELECTROSTATIC SENSITIVE DEVICE
OBSERVE HANDLING PRECAUTIONS**

Note: Multiplier Performance Characteristics (Typical Performance at 25°C)
Vd1= 2V, Vd2= Vd3= Vd4= 5V, Id1= 5mA, Id2+Id3+Id4= 245mA

Information furnished by Analog Devices is believed to be accurate and reliable. However, no responsibility is assumed by Analog Devices for its use, nor for any infringements of patents or other rights of third parties that may result from its use. Specifications subject to change without notice. No license is granted by implication or otherwise under any patent or patent rights of Analog Devices. Trademarks and registered trademarks are the property of their respective owners.

For price, delivery, and to place orders: Analog Devices, Inc., One Technology Way, P.O. Box 9106, Norwood, MA 02062-9106
Phone: 781-329-4700 • Order online at www.analog.com
Application Support: Phone: 1-800-ANALOG-D

GaAs HEMT MMIC DRIVER AMPLIFIER, 17.5 - 41.0 GHz

Outline Drawing

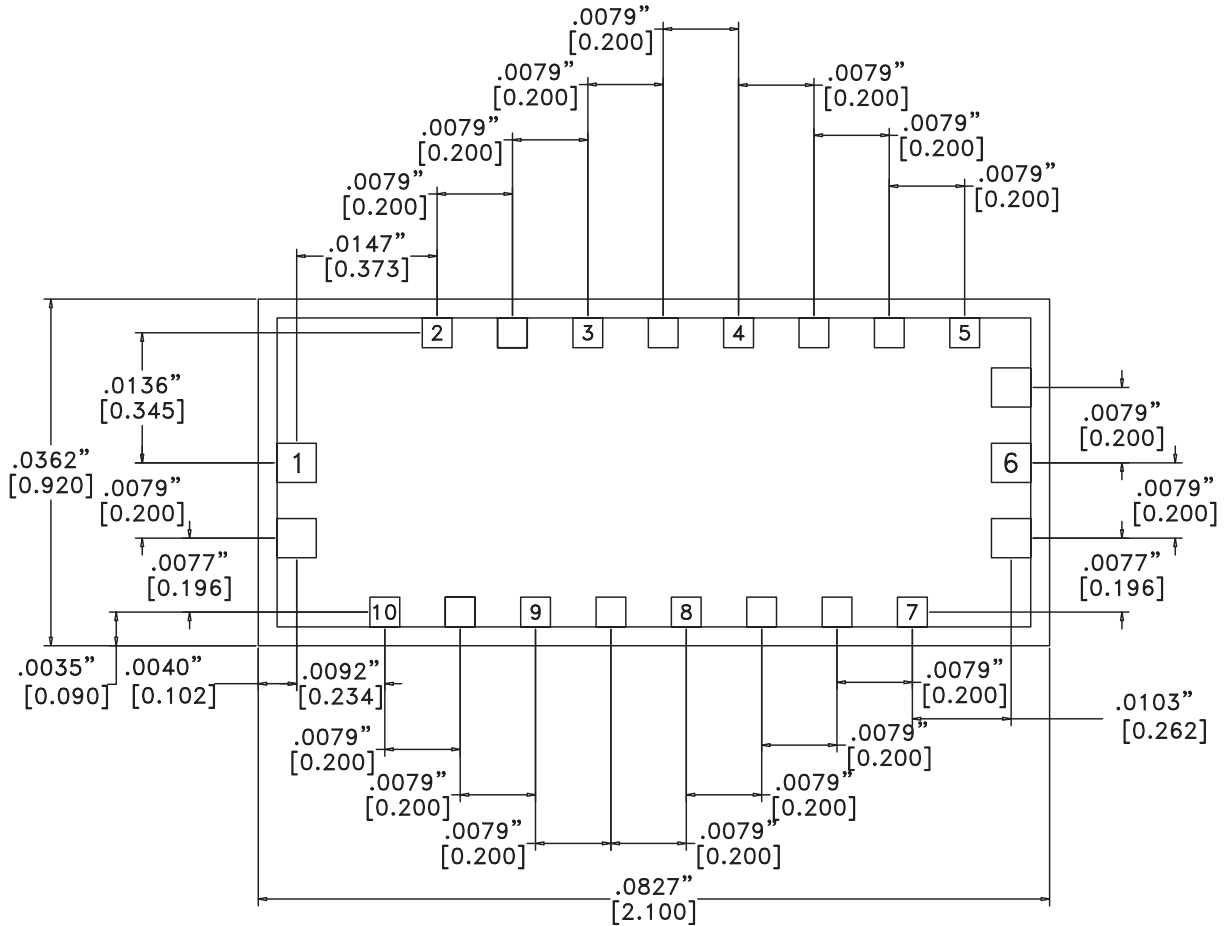

NOTES:

1. ALL DIMENSIONS ARE IN INCHES [MM].
2. TYPICAL BOND PAD IS .004" SQUARE.
3. BACKSIDE METALLIZATION: GOLD.
4. BACKSIDE METAL IS GROUND.
5. BOND PAD METALLIZATION: GOLD.
6. CONNECTION NOT REQUIRED FOR UNLABELED BOND PADS.
7. OVERALL DIE SIZE $\pm .002$ "

Die Packaging Information ^[1]



Standard	Alternate
GP-2 (Gel Pack)	[2]

[1] Refer to the "Packaging Information" section for die packaging dimensions.

[2] For alternate packaging information contact Hittite Microwave Corporation.

GaAs HEMT MMIC DRIVER AMPLIFIER, 17.5 - 41.0 GHz

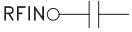
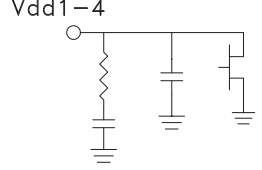
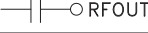
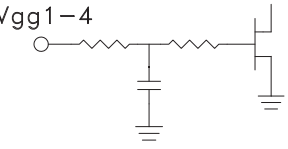
Pad Descriptions

Pad Number	Function	Pad Description	Interface Schematic
1	RFIN	This pad is AC coupled and matched to 50 Ohms.	
2 - 5	Vdd1-4	Power supply voltage for amplifier. See Assembly Diagram for required external components.	
6	RFOUT	This pad is AC coupled and matched to 50 Ohms.	
7 - 10	Vgg1-4	Gate control for amplifier. Please follow "MMIC Amplifier Biasing Procedure" application note. See assembly for required external components.	
Die Bottom	GND	Die Bottom must be connected to RF/DC ground.	

**GaAs HEMT MMIC DRIVER
AMPLIFIER, 17.5 - 41.0 GHz**

Assembly Diagram

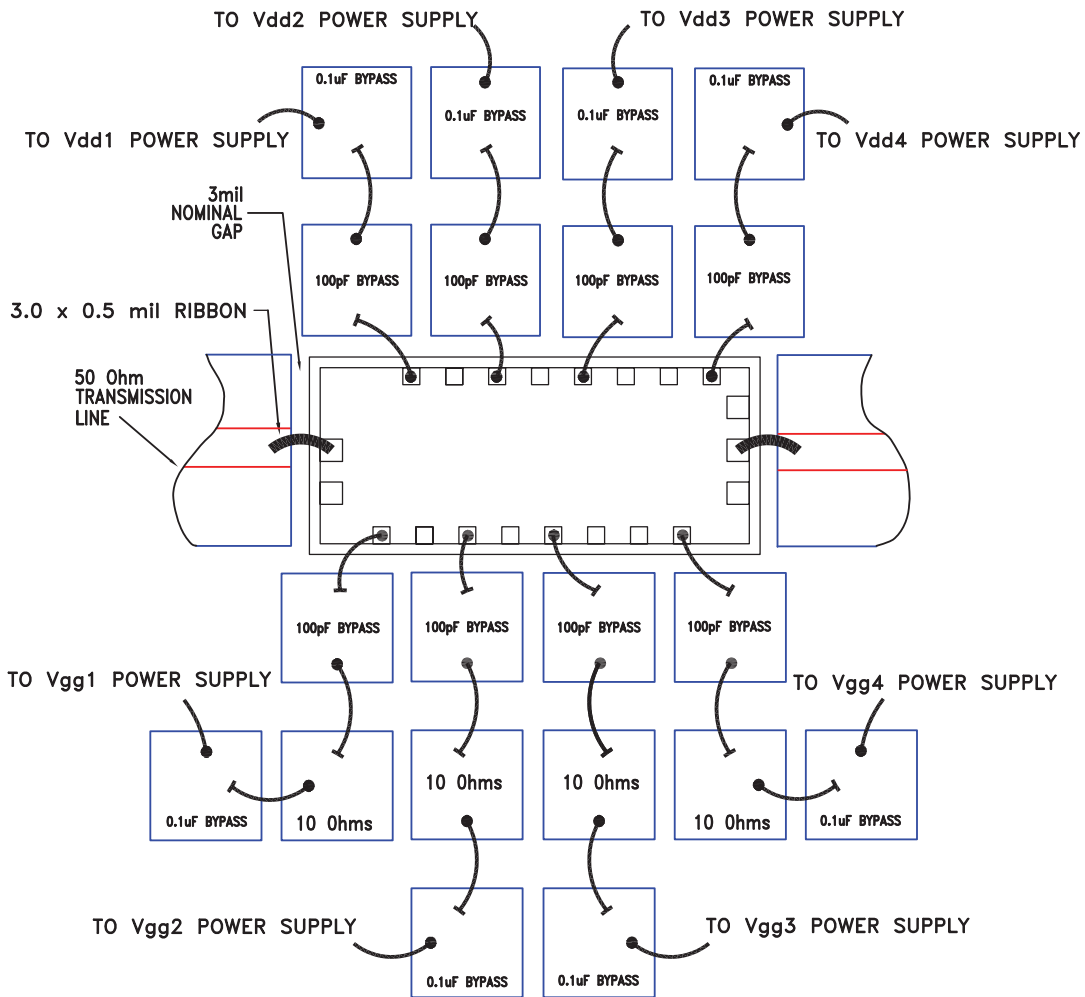

Note 1: Bypass caps should be 100 pF (approximately) ceramic (single-layer) placed no farther than 30 mils from the amplifier.

Note 2: Best performance obtained from use of <10 mil (long) by 3 by 0.5mil ribbons on input and output.

Note 3: Vdd3 can be biased using on-chip pads Vdd3 or Vdd4