



Chipsmall Limited consists of a professional team with an average of over 10 year of expertise in the distribution of electronic components. Based in Hongkong, we have already established firm and mutual-benefit business relationships with customers from,Europe,America and south Asia,supplying obsolete and hard-to-find components to meet their specific needs.

With the principle of “Quality Parts,Customers Priority,Honest Operation,and Considerate Service”,our business mainly focus on the distribution of electronic components. Line cards we deal with include Microchip,ALPS,ROHM,Xilinx,Pulse,ON,Everlight and Freescale. Main products comprise IC,Modules,Potentiometer,IC Socket,Relay,Connector.Our parts cover such applications as commercial,industrial, and automotives areas.

We are looking forward to setting up business relationship with you and hope to provide you with the best service and solution. Let us make a better world for our industry!



Contact us

Tel: +86-755-8981 8866 Fax: +86-755-8427 6832

Email & Skype: info@chipsmall.com Web: www.chipsmall.com

Address: A1208, Overseas Decoration Building, #122 Zhenhua RD., Futian, Shenzhen, China



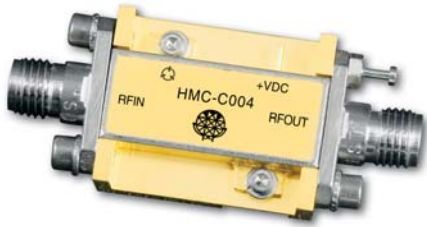

WIDEBAND DRIVER AMPLIFIER MODULE, 10 MHz - 20 GHz

Features

- Gain: 15 dB
- Saturated Output Power: +24 dBm
- 50 Ohm Matched Input/Output
- Regulated Supply and Bias Sequencing
- Hermetically Sealed Module
- Field Replaceable SMA connectors
- 55 to +85°C Operating Temperature

Typical Applications

The HMC-C004 Wideband Driver is ideal for:

- OC192 LN/MZ Modulator Driver
- Telecom Infrastructure
- Microwave Radio & VSAT
- Military & Space
- Test Instrumentation

Functional Diagram

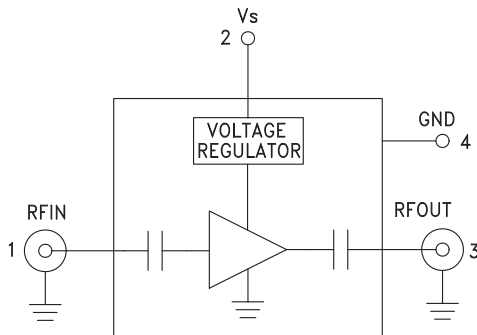

General Description

The HMC-C004 is a GaAs MMIC PHEMT Distributed Driver Amplifier in a miniature, hermetic module with replaceable SMA connectors which operates between 10 MHz and 20 GHz. The self-biased amplifier provides 15 dB of gain, 3 to 4 dB noise figure and +24 dBm of saturated output power while requiring a single +12V supply. Gain flatness is excellent at ± 0.5 dB as well as ± 2 deg deviation from linear phase from 0.01 to 10 GHz making the HMC-C004 ideal for OC192 fiber optic LN/MZ modulator driver applications. The wideband amplifier I/Os are internally matched to 50 Ohms and are internally DC blocked.

Electrical Specifications, $T_A = +25^\circ\text{C}$, $V_s = +11.6\text{V}$ to $+12.4\text{V}$

Parameter	Min.	Typ.	Max.	Min.	Typ.	Max.	Min.	Typ.	Max.	Units
Frequency Range	0.010 - 6.0			6.0 - 12.0			12.0 - 20.0			GHz
Gain	14	16		13	15		10	13		dB
Gain Flatness		± 0.5			± 0.5			± 1.0		dB
Gain Variation Over Temperature		0.012	0.02		0.012	0.02		0.012	0.02	dB/°C
Noise Figure		3			3			4		dB
Input Return Loss		19			17			10		dB
Output Return Loss		14			14			10		dB
Output Power for 1 dB Compression (P1dB)	20	23		19	22		17	20		dBm
Saturated Output Power (Psat)		25			24			22		dBm
Output Third Order Intercept (IP3)		33			30			26		dBm
Saturated Output Voltage		10			10			8		Vpk-pk
Group Delay		± 3			± 3			± 3		ps
Spurious Response		-50			-60			-60		dBc
Supply Current		195			195			195		mA

Information furnished by Analog Devices is believed to be accurate and reliable. However, no responsibility is assumed by Analog Devices for its use, nor for any infringements of patents or other rights of third parties that may result from its use. Specifications subject to change without notice. No license is granted by implication or otherwise under any patent or patent rights of Analog Devices. Trademarks and registered trademarks are the property of their respective owners.

For price, delivery, and to place orders: Analog Devices, Inc., One Technology Way, P.O. Box 9106, Norwood, MA 02062-9106 Phone: 781-329-4700 • Order online at www.analog.com Application Support: Phone: 1-800-ANALOG-D

HMC-C004* PRODUCT PAGE QUICK LINKS

Last Content Update: 02/23/2017

COMPARABLE PARTS

View a parametric search of comparable parts.

DOCUMENTATION

Application Notes

- AN-1363: Meeting Biasing Requirements of Externally Biased RF/Microwave Amplifiers with Active Bias Controllers

Data Sheet

- HMC-C004 Data Sheet

TOOLS AND SIMULATIONS

- HMC-C004 S-Parameter

REFERENCE MATERIALS

Technical Articles

- Hittite's Connectorized Modules Extend HMC-T2000 Synthesizer Performance

DESIGN RESOURCES

- HMC-C004 Material Declaration
- PCN-PDN Information
- Quality And Reliability
- Symbols and Footprints

DISCUSSIONS

View all HMC-C004 EngineerZone Discussions.

SAMPLE AND BUY

Visit the product page to see pricing options.

TECHNICAL SUPPORT

Submit a technical question or find your regional support number.

DOCUMENT FEEDBACK

Submit feedback for this data sheet.



**WIDEBAND DRIVER AMPLIFIER
MODULE, 10 MHz - 20 GHz**

Gain & Return Loss

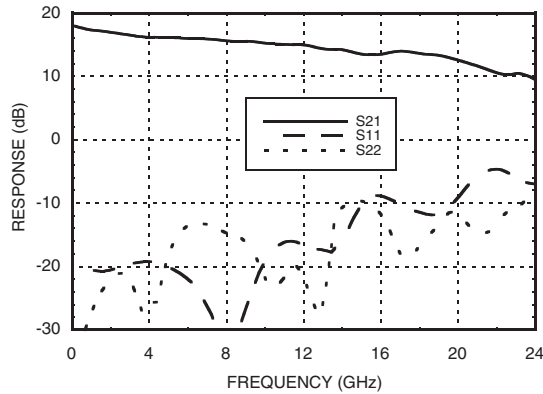

Gain vs. Temperature

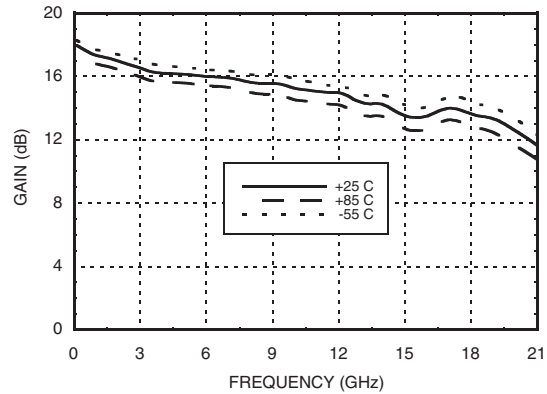

Input Return Loss vs. Temperature

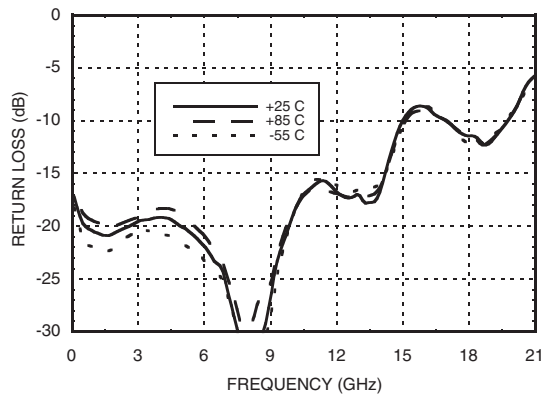

Output Return Loss vs. Temperature

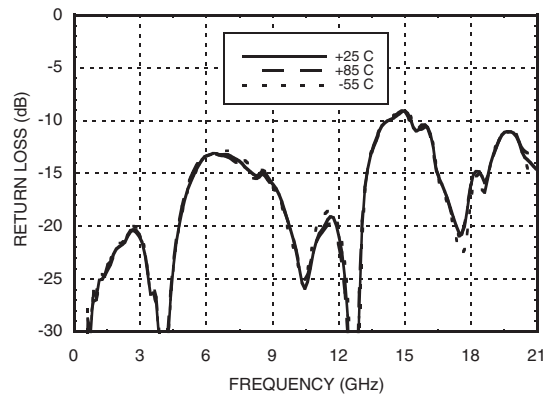

Reverse Isolation vs. Temperature

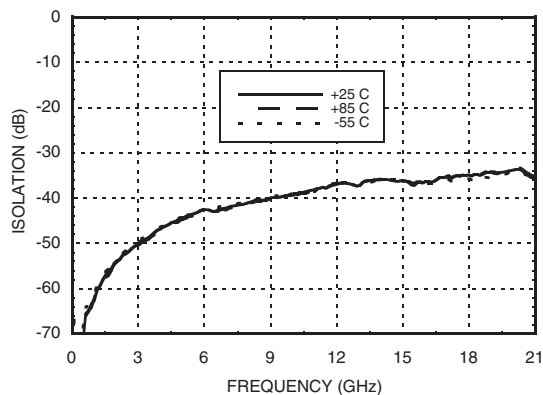

Noise Figure vs. Temperature

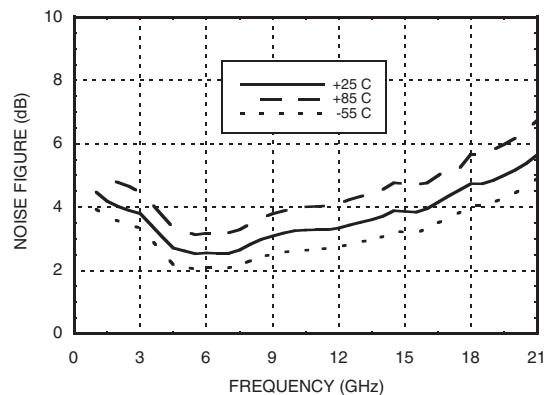

Information furnished by Analog Devices is believed to be accurate and reliable. However, no responsibility is assumed by Analog Devices for its use, nor for any infringements of patents or other rights of third parties that may result from its use. Specifications subject to change without notice. No license is granted by implication or otherwise under any patent or patent rights of Analog Devices. Trademarks and registered trademarks are the property of their respective owners.

For price, delivery, and to place orders: Analog Devices, Inc., One Technology Way, P.O. Box 9106, Norwood, MA 02062-9106 Phone: 781-329-4700 • Order online at www.analog.com Application Support: Phone: 1-800-ANALOG-D



**WIDEBAND DRIVER AMPLIFIER
MODULE, 10 MHz - 20 GHz**

P1dB vs. Temperature

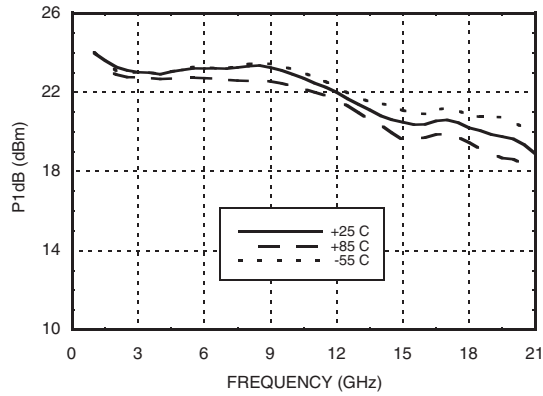

Psat vs. Temperature

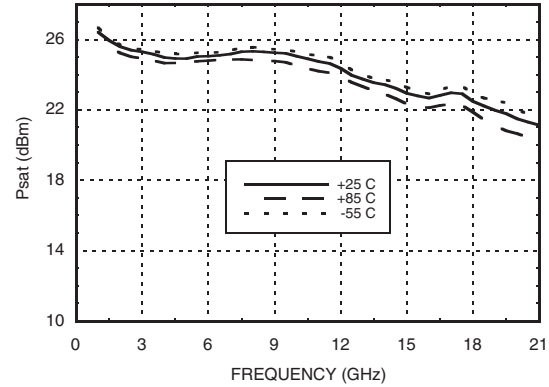

Output IP3 vs. Temperature

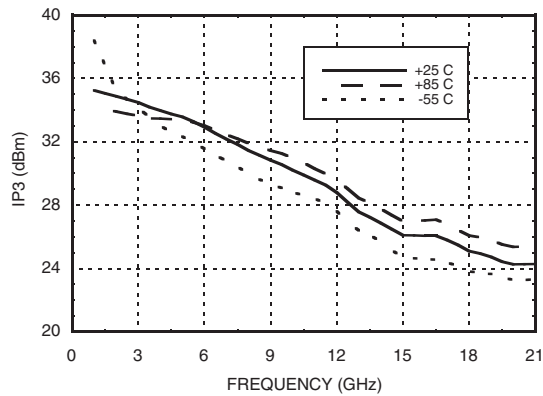

Group Delay

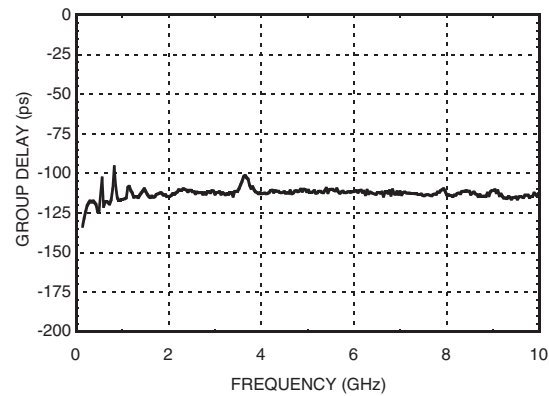

Deviation from Linear Phase

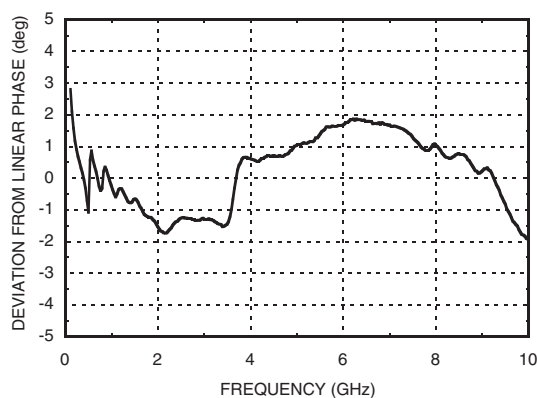

Low Frequency Gain and Return Loss

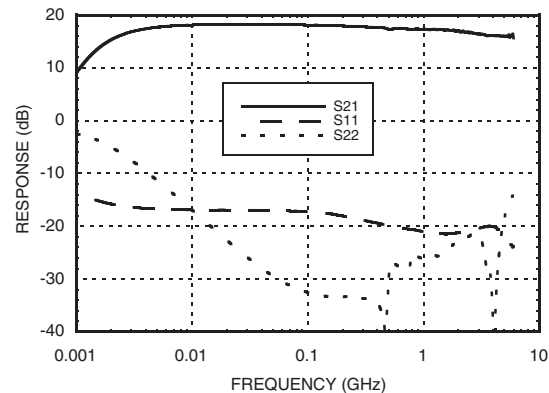

Information furnished by Analog Devices is believed to be accurate and reliable. However, no responsibility is assumed by Analog Devices for its use, nor for any infringements of patents or other rights of third parties that may result from its use. Specifications subject to change without notice. No license is granted by implication or otherwise under any patent or patent rights of Analog Devices. Trademarks and registered trademarks are the property of their respective owners.

For price, delivery, and to place orders: Analog Devices, Inc., One Technology Way, P.O. Box 9106, Norwood, MA 02062-9106 Phone: 781-329-4700 • Order online at www.analog.com Application Support: Phone: 1-800-ANALOG-D

WIDEBAND DRIVER AMPLIFIER MODULE, 10 MHz - 20 GHz



Input OC-192 Eye Diagram [1][2]

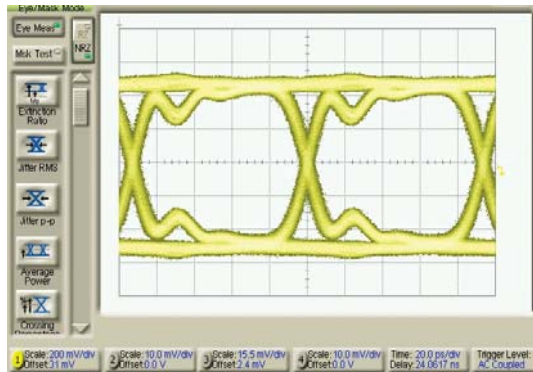

Output OC-192 Eye Diagram [1][3]

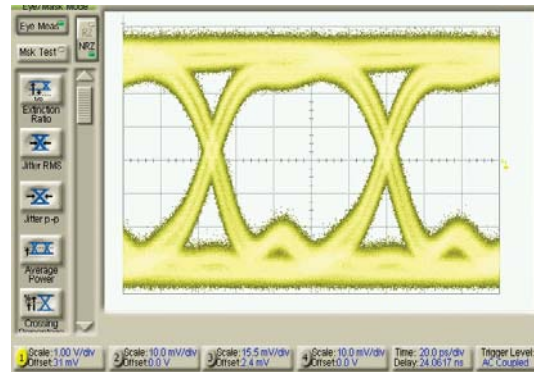

[1] Test Conditions:

Pattern generated with an Agilent N4901B Serial BERT
Eye diagram data presented on an infiniium DCA 86100A.
Rate = 10.709 GB/s
Pseudo Random Code = 2²³-1

[2] Vertical Scale = 200 mV/Div.

[3] Vertical Scale = 1 V/Div.

Absolute Maximum Ratings

Bias Supply Voltage (Vs)	+11 Vdc to +13 Vdc
RF Input Power (RFIN)	+23 dBm
Storage Temperature	-65 to +150 °C
Operating Temperature	-55 to +85 °C



ELECTROSTATIC SENSITIVE DEVICE
OBSERVE HANDLING PRECAUTIONS

Pin Descriptions

Pin Number	Function	Description	Interface Schematic
1	RFIN & RF Ground	RF input connector, SMA female, field replaceable. This pin is AC coupled and matched to 50 Ohms.	
2	Vs	Power supply voltage for the amplifier.	
3	RFOUT & RF Ground	RF output connector, SMA female. This pin is AC coupled and matched to 50 Ohms.	
4	GND	Power supply ground.	

Information furnished by Analog Devices is believed to be accurate and reliable. However, no responsibility is assumed by Analog Devices for its use, nor for any infringements of patents or other rights of third parties that may result from its use. Specifications subject to change without notice. No license is granted by implication or otherwise under any patent or patent rights of Analog Devices. Trademarks and registered trademarks are the property of their respective owners.

For price, delivery, and to place orders: Analog Devices, Inc., One Technology Way, P.O. Box 9106, Norwood, MA 02062-9106
Phone: 781-329-4700 • Order online at www.analog.com
Application Support: Phone: 1-800-ANALOG-D



**WIDEBAND DRIVER AMPLIFIER
MODULE, 10 MHz - 20 GHz**

Outline Drawing

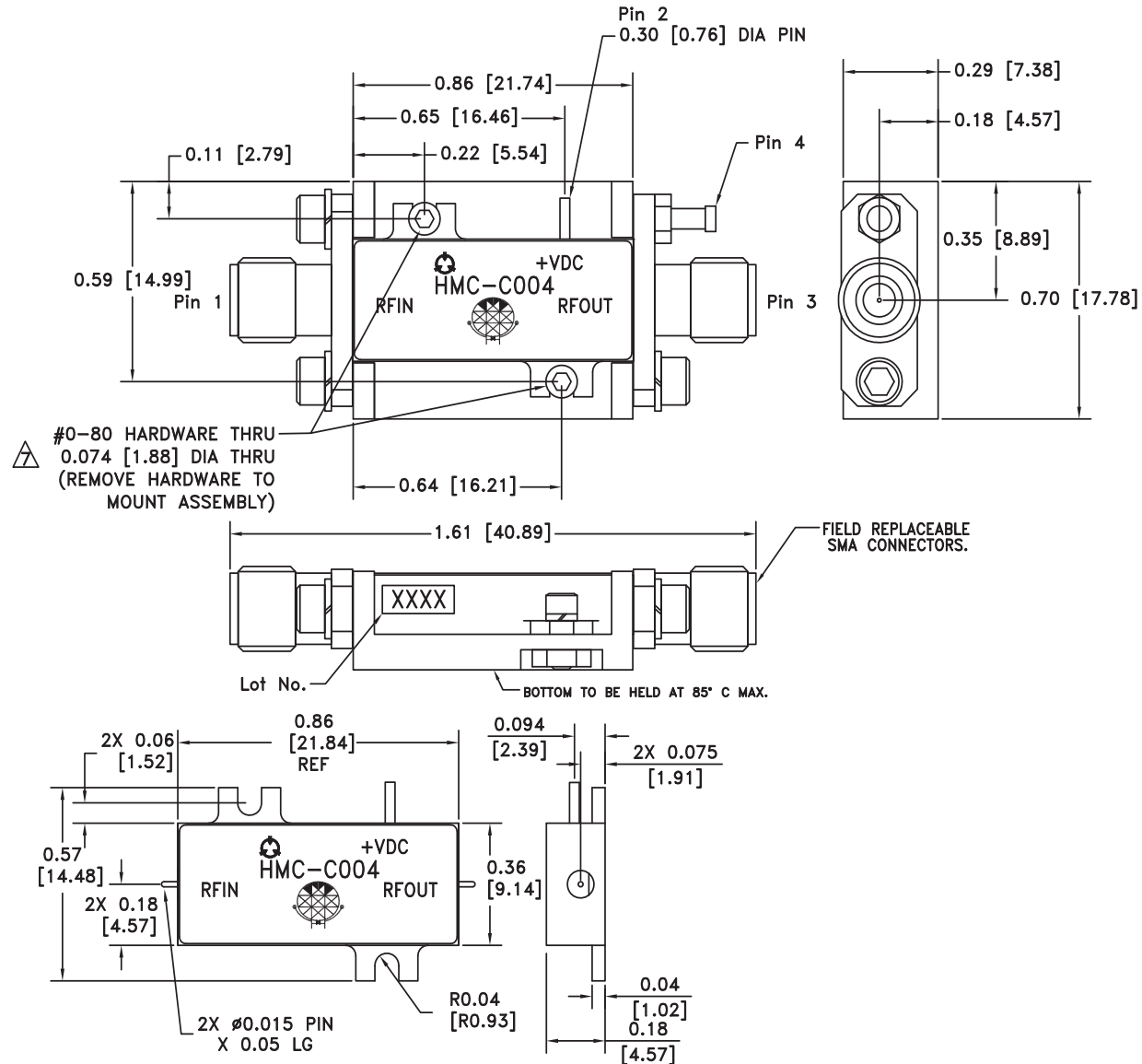

Package Information

Package Type	C-3
Package Weight [1]	12 gms [2]
Spacer Weight	N/A

[1] Includes the connectors

[2] ±1 gms Tolerance

NOTES:

1. PACKAGE, LEADS, COVER MATERIAL: KOVAR™
2. SPACER MATERIAL: ALUMINUM
3. PLATING: ELECTROLYTIC GOLD 50 MICROINCHES MIN., OVER ELECTROLYTIC NICKEL 75 MICROINCHES MIN.
4. ALL DIMENSIONS ARE IN INCHES [MILLIMETERS].
5. TOLERANCES ±.005 [0.13] UNLESS OTHERWISE SPECIFIED.
6. FIELD REPLACEABLE SMA CONNECTORS. TENSOLITE 5602 - 5CCSF OR EQUIVALENT.

▲ TO MOUNT MODULE TO SYSTEM PLATFORM REPLACE 0-80 HARDWARE WITH DESIRED MOUNTING SCREWS.

Information furnished by Analog Devices is believed to be accurate and reliable. However, no responsibility is assumed by Analog Devices for its use, nor for any infringements of patents or other rights of third parties that may result from its use. Specifications subject to change without notice. No license is granted by implication or otherwise under any patent or patent rights of Analog Devices. Trademarks and registered trademarks are the property of their respective owners.

For price, delivery, and to place orders: Analog Devices, Inc., One Technology Way, P.O. Box 9106, Norwood, MA 02062-9106 Phone: 781-329-4700 • Order online at www.analog.com Application Support: Phone: 1-800-ANALOG-D

**WIDEBAND DRIVER AMPLIFIER
MODULE, 10 MHz - 20 GHz****Notes:**