



Chipsmall Limited consists of a professional team with an average of over 10 year of expertise in the distribution of electronic components. Based in Hongkong, we have already established firm and mutual-benefit business relationships with customers from,Europe,America and south Asia,supplying obsolete and hard-to-find components to meet their specific needs.

With the principle of “Quality Parts,Customers Priority,Honest Operation,and Considerate Service”,our business mainly focus on the distribution of electronic components. Line cards we deal with include Microchip,ALPS,ROHM,Xilinx,Pulse,ON,Everlight and Freescale. Main products comprise IC,Modules,Potentiometer,IC Socket,Relay,Connector.Our parts cover such applications as commercial,industrial, and automotives areas.

We are looking forward to setting up business relationship with you and hope to provide you with the best service and solution. Let us make a better world for our industry!



Contact us

Tel: +86-755-8981 8866 Fax: +86-755-8427 6832

Email & Skype: info@chipsmall.com Web: www.chipsmall.com

Address: A1208, Overseas Decoration Building, #122 Zhenhua RD., Futian, Shenzhen, China



WIDEBAND HIGH GAIN POWER AMPLIFIER MODULE, 2 - 20 GHz



Typical Applications

The HMC-C026 Wideband PA is ideal for:

- Telecom Infrastructure
- Microwave Radio & VSAT
- Military & Space
- Test Instrumentation
- Fiber Optics

Functional Diagram

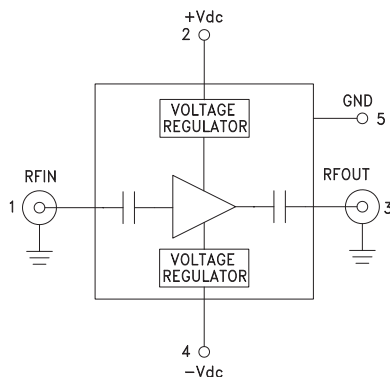

Features

- Gain: 31 dB @ 6 GHz
- P1dB Output Power: +26 dBm @ 6 GHz
- Noise Figure: 2.5 dB @ 8 GHz
- Spurious-Free Operation
- Regulated Supply and Bias Sequencing
- Hermetically Sealed Module
- Field Replaceable SMA connectors
- 55 °C to +85 °C Operating Temperature

General Description

The HMC-C026 is a GaAs MMIC pHEMT Distributed Power Amplifier in a miniature, hermetic module with replaceable SMA connectors which operates between 2 and 20 GHz. The amplifier provides 31 dB of gain, 2.5 dB noise figure, +30 dBm output IP3 and up to +26 dBm of output power at 1 dB gain compression. The wideband amplifier I/Os are internally matched to 50 Ohms and are DC blocked making the HMC-C026 ideal for EW, ECM RADAR and test equipment applications. Integrated voltage regulators allow for flexible biasing of both the negative and positive supply pins, while internal bias sequencing circuitry assures robust operation.

Electrical Specifications, $T_A = +25^\circ\text{C}$, +Vdc = +11V to +16V, -Vdc = -3V to -12V

Parameter	Min.	Typ.	Max.	Min.	Typ.	Max.	Min.	Typ.	Max.	Min.	Typ.	Max.	Units
Frequency Range	2 - 6			6 - 12			12 - 16			16 - 20			GHz
Gain	28	31		26	29		24	27		19	22		dB
Gain Flatness		±0.25			±0.75			±1.0			±2.0		dB
Gain Variation Over Temperature		0.03	0.04		0.03	0.04		0.03	0.04		0.03	0.04	dB/°C
Noise Figure		3.0	5.0		2.5	3.5		3.0	4.0		3.5	5.0	dB
Input Return Loss		15			15			13			10		dB
Output Return Loss		15			15			10			8		dB
Output Power for 1 dB Compression (P1dB)	23	26		22.5	25.5		20	24		18	21		dBm
Saturated Output Power (P _{sat})		27.5			27			25			23		dBm
Output Third Order Intercept (IP3)		33			30			27			24		dBm
Positive Supply Current (+IDC)		400	450		400	450		400	450		400	450	mA
Negative Supply Current (-IDC)		3.2	5		3.2	5		3.2	5		3.2	5	mA

Information furnished by Analog Devices is believed to be accurate and reliable. However, no responsibility is assumed by Analog Devices for its use, nor for any infringements of patents or other rights of third parties that may result from its use. Specifications subject to change without notice. No license is granted by implication or otherwise under any patent or patent rights of Analog Devices. Trademarks and registered trademarks are the property of their respective owners.

For price, delivery, and to place orders: Analog Devices, Inc., One Technology Way, P.O. Box 9106, Norwood, MA 02062-9106
Phone: 781-329-4700 • Order online at www.analog.com
Application Support: Phone: 1-800-ANALOG-D

HMC-C026* PRODUCT PAGE QUICK LINKS

Last Content Update: 02/23/2017

COMPARABLE PARTS

View a parametric search of comparable parts.

DOCUMENTATION

Application Notes

- AN-1363: Meeting Biasing Requirements of Externally Biased RF/Microwave Amplifiers with Active Bias Controllers

Data Sheet

- HMC-C026 Data Sheet

TOOLS AND SIMULATIONS

- HMC-C026 S-Parameter

DESIGN RESOURCES

- HMC-C026 Material Declaration
- PCN-PDN Information
- Quality And Reliability
- Symbols and Footprints

DISCUSSIONS

View all HMC-C026 EngineerZone Discussions.

SAMPLE AND BUY

Visit the product page to see pricing options.

TECHNICAL SUPPORT

Submit a technical question or find your regional support number.

DOCUMENT FEEDBACK

Submit feedback for this data sheet.



**WIDEBAND HIGH GAIN POWER AMPLIFIER
MODULE, 2 - 20 GHz**

Gain & Return Loss

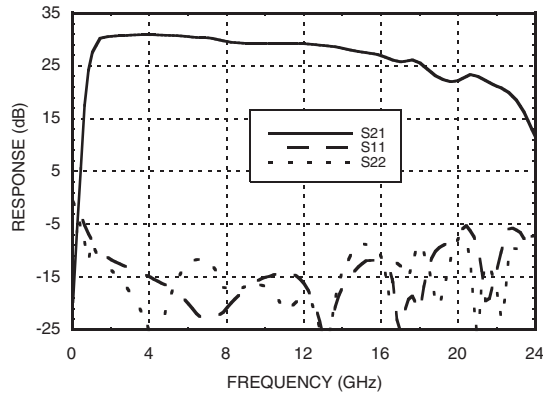

Gain vs. Temperature

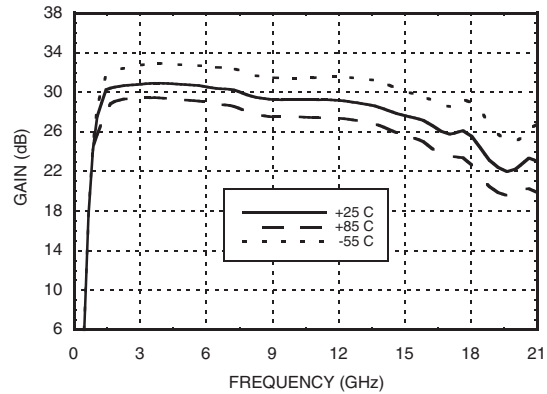

Input Return Loss vs. Temperature

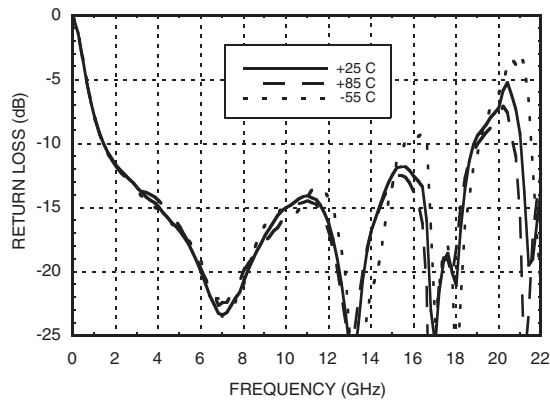

Output Return Loss vs. Temperature

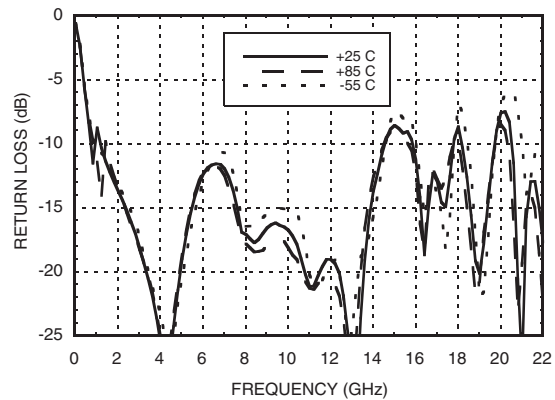

Reverse Isolation vs. Temperature

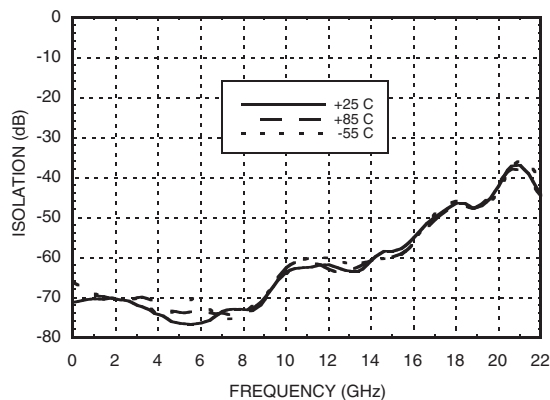

Noise Figure vs. Temperature

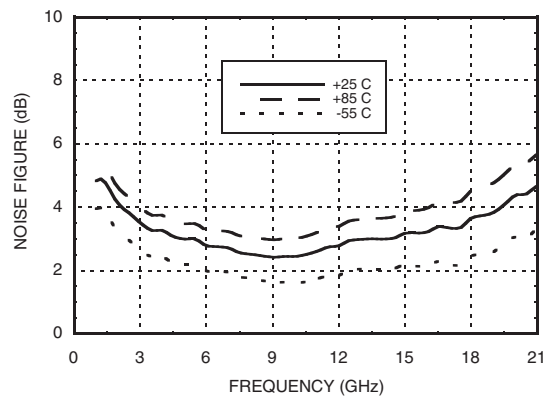

Information furnished by Analog Devices is believed to be accurate and reliable. However, no responsibility is assumed by Analog Devices for its use, nor for any infringements of patents or other rights of third parties that may result from its use. Specifications subject to change without notice. No license is granted by implication or otherwise under any patent or patent rights of Analog Devices. Trademarks and registered trademarks are the property of their respective owners.

For price, delivery, and to place orders: Analog Devices, Inc., One Technology Way, P.O. Box 9106, Norwood, MA 02062-9106 Phone: 781-329-4700 • Order online at www.analog.com Application Support: Phone: 1-800-ANALOG-D



**WIDEBAND HIGH GAIN POWER AMPLIFIER
MODULE, 2 - 20 GHz**

P1dB vs. Temperature

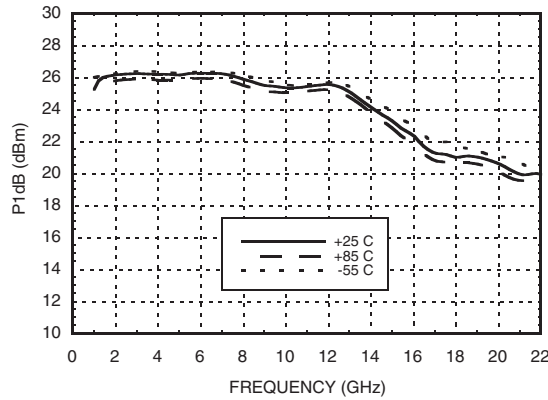

Psat vs. Temperature

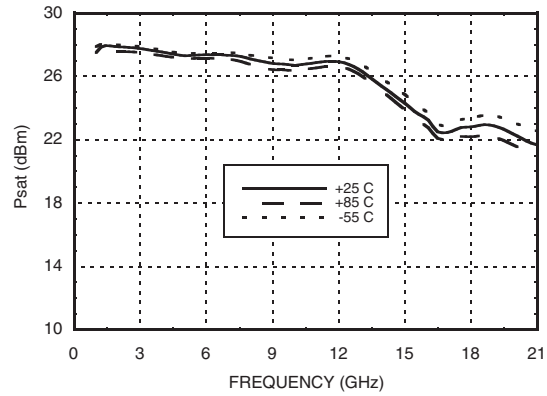

Output IP3 vs. Temperature

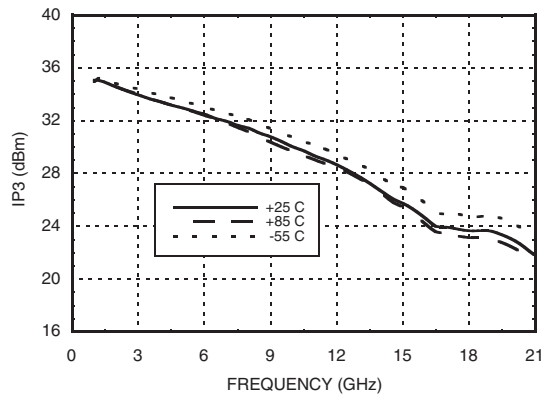

Absolute Maximum Ratings

RF Input Power (RFIN)	+23 dBm
Positive Bias Supply Voltage (+Vdc)	+17V Max
Negative Bias Supply (-Vdc)	-16V Min.
Thermal Resistance (at +Vdc = 12V, -Vdc = -4V, DC Power = 4.8 Watts)	15.9 °C/W
Storage Temperature	-65 to +150 °C
Operating Temperature	-55 to +85 °C





**ELECTROSTATIC SENSITIVE DEVICE
OBSERVE HANDLING PRECAUTIONS**

Information furnished by Analog Devices is believed to be accurate and reliable. However, no responsibility is assumed by Analog Devices for its use, nor for any infringements of patents or other rights of third parties that may result from its use. Specifications subject to change without notice. No license is granted by implication or otherwise under any patent or patent rights of Analog Devices. Trademarks and registered trademarks are the property of their respective owners.

For price, delivery, and to place orders: Analog Devices, Inc., One Technology Way, P.O. Box 9106, Norwood, MA 02062-9106 Phone: 781-329-4700 • Order online at www.analog.com Application Support: Phone: 1-800-ANALOG-D

**WIDEBAND HIGH GAIN POWER AMPLIFIER
MODULE, 2 - 20 GHz**

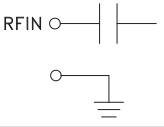
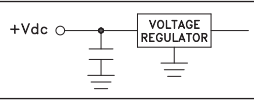
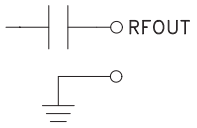
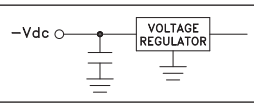
Pin Descriptions

Pin Number	Function	Description	Interface Schematic
1	RFIN & RF Ground	RF input connector, SMA female, field replaceable. This pin is AC coupled and matched to 50 Ohms.	
2	+Vdc	Positive power supply voltage for the amplifier.	
3	RFOUT & RF Ground	RF output connector, SMA female. This pin is AC coupled and matched to 50 Ohms.	
4	-Vdc	Negative power supply voltage for the amplifier.	
5	GND	Power supply ground.	

**WIDEBAND HIGH GAIN POWER AMPLIFIER
MODULE, 2 - 20 GHz**



Outline Drawing

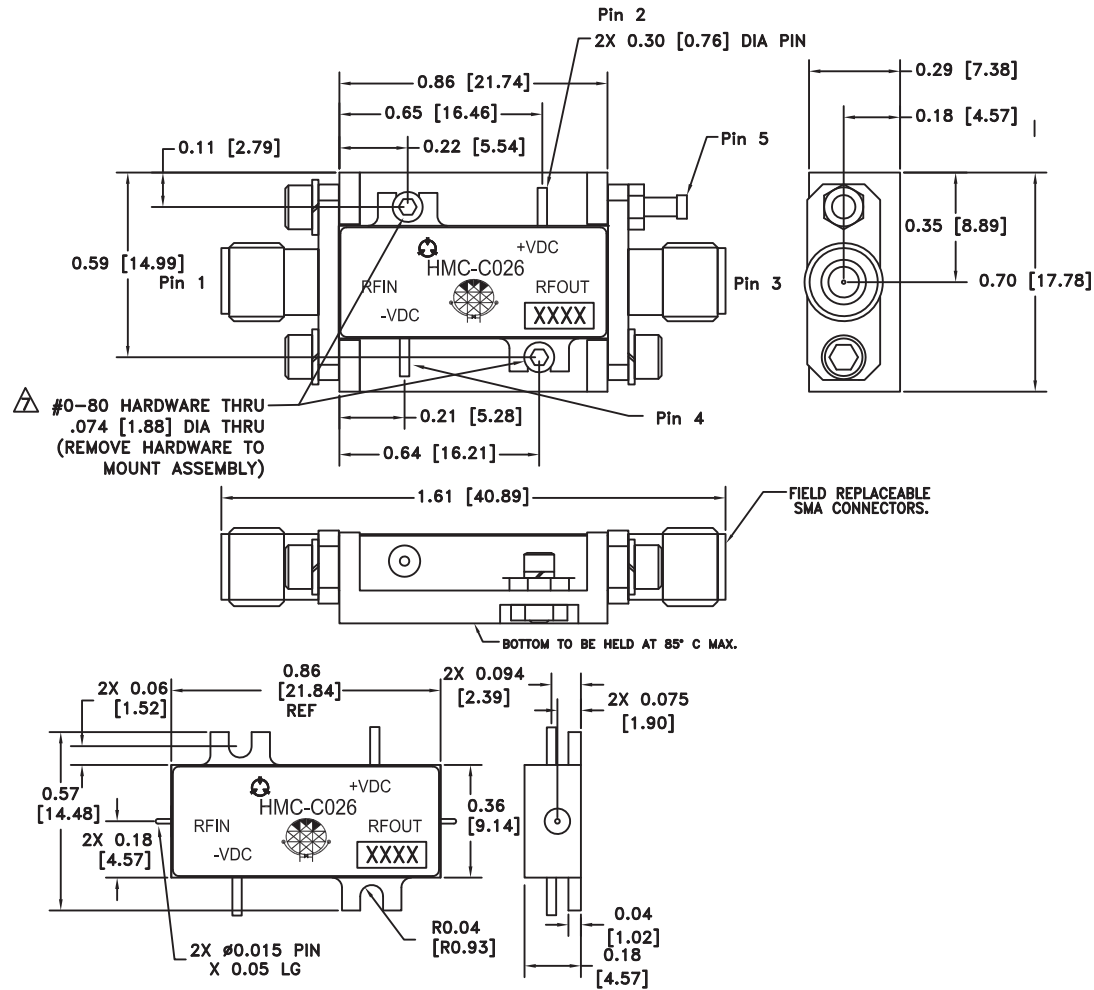

Package Information

Package Type	C-3B
Package Weight ^[1]	12 gms ^[2]
Spacer Weight	N/A

[1] Includes the connectors

[2] ±1 gms Tolerance

NOTES:

1. PACKAGE, LEADS, COVER MATERIAL: KOVAR™
2. SPACER MATERIAL: ALUMINUM
3. PLATING: ELECTROLYTIC GOLD 50 MICROINCHES MIN., OVER ELECTROLYTIC NICKEL 75 MICROINCHES MIN.
4. ALL DIMENSIONS ARE IN INCHES [MILLIMETERS].
5. TOLERANCES ±.005 [0.13] UNLESS OTHERWISE SPECIFIED.
6. FIELD REPLACEABLE SMA CONNECTORS. TENSOLITE 5602 - 5CCSF OR EQUIVALENT.

⚠ TO MOUNT MODULE TO SYSTEM PLATFORM REPLACE 0 - 80 HARDWARE WITH DESIRED MOUNTING SCREWS.

v03.1007

**WIDEBAND HIGH GAIN POWER AMPLIFIER
MODULE, 2 - 20 GHz****Notes:**