



Chipsmall Limited consists of a professional team with an average of over 10 year of expertise in the distribution of electronic components. Based in Hongkong, we have already established firm and mutual-benefit business relationships with customers from,Europe,America and south Asia,supplying obsolete and hard-to-find components to meet their specific needs.

With the principle of “Quality Parts,Customers Priority,Honest Operation,and Considerate Service”,our business mainly focus on the distribution of electronic components. Line cards we deal with include Microchip,ALPS,ROHM,Xilinx,Pulse,ON,Everlight and Freescale. Main products comprise IC,Modules,Potentiometer,IC Socket,Relay,Connector.Our parts cover such applications as commercial,industrial, and automotives areas.

We are looking forward to setting up business relationship with you and hope to provide you with the best service and solution. Let us make a better world for our industry!



Contact us

Tel: +86-755-8981 8866 Fax: +86-755-8427 6832

Email & Skype: info@chipsmall.com Web: www.chipsmall.com

Address: A1208, Overseas Decoration Building, #122 Zhenhua RD., Futian, Shenzhen, China



GaAs MMIC I/Q MIXER MODULE 30 - 38 GHz



Typical Applications

The HMC-C047 is ideal for:

- Point-to-Point Radios
- Point-to-Multi-Point Radios & VSAT
- Test Equipment & Sensors
- Military End-Use

Functional Diagram

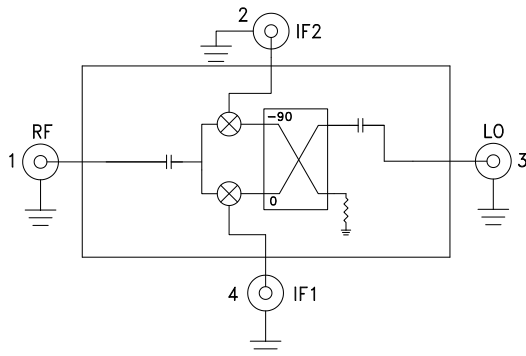

Features

- Wide IF Bandwidth: DC - 3.5 GHz
- Image Rejection: 15 dB
- LO to RF Isolation: 35 dB
- High Input IP3: 19 dBm
- Hermetically Sealed Module
- Field Replaceable SMA Connectors
- 55 to +85 °C Operating Temperature

General Description

The HMC-C047 is a passive I/Q MMIC mixer housed in a miniature hermetic module which can be used as either an Image Reject Mixer (IRM) or a Single Sideband Upconverter. The module utilizes two standard Hittite double balanced mixer cells and a 90 degree hybrid fabricated on a GaAs MESFET process. A low frequency quadrature hybrid was used to produce a 100 MHz Upper Side Band (USB) IF output. This MMIC based module is a more reliable and consistent alternative to hybrid style I/Q Mixers and Single Sideband Converter assemblies. The module features removable SMA connectors which can be detached to allow direct connection of the I/O pins to a microstrip or coplanar circuit.

Electrical Specifications, $T_A = +25^\circ \text{C}$, $IF = 100 \text{ MHz}$, $LO = +17 \text{ dBm}^*$

Parameter	Min.	Typ.	Max.	Min.	Typ.	Max.	Units
Frequency Range, RF/LO	30 - 34		34 - 38				GHz
Frequency Range, IF	DC - 3.5		DC - 3.5				GHz
Conversion Loss (As IRM)		10.5	13.5		11	14	dB
Image Rejection	11	15		11	15		dB
1 dB Compression (Input)		17			17		dBm
LO to RF Isolation	30	35		23	34		dB
LO to IF Isolation	18	25		14	23		dB
IP3 (Input)		19			19		dBm
Amplitude Balance		0.5			1		dB
Phase Balance		13			12		Deg

* Unless otherwise noted, all measurements performed as downconverter.

HMC-C047* PRODUCT PAGE QUICK LINKS

Last Content Update: 02/23/2017

[COMPARABLE PARTS](#)

View a parametric search of comparable parts.

[DOCUMENTATION](#)

Data Sheet

- [HMC-C047 Data Sheet](#)

[DESIGN RESOURCES](#)

- [HMC-C047 Material Declaration](#)
- [PCN-PDN Information](#)
- [Quality And Reliability](#)
- [Symbols and Footprints](#)

[DISCUSSIONS](#)

View all HMC-C047 EngineerZone Discussions.

[SAMPLE AND BUY](#)

Visit the product page to see pricing options.

[TECHNICAL SUPPORT](#)

Submit a technical question or find your regional support number.

[DOCUMENT FEEDBACK](#)

Submit feedback for this data sheet.



Data taken As IRM With External IF 90° Hybrid
Conversion Gain vs. Temperature

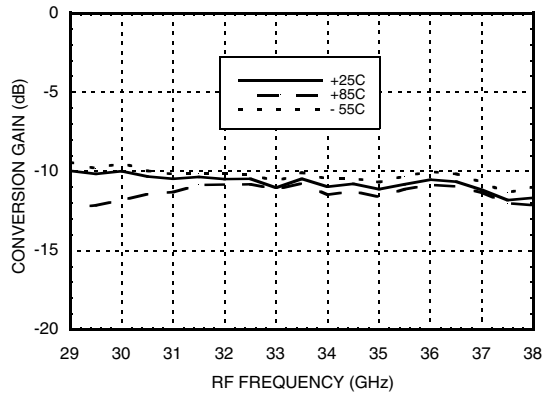

GaAs MMIC I/Q MIXER MODULE
30 - 38 GHz

Image Rejection vs. Temperature

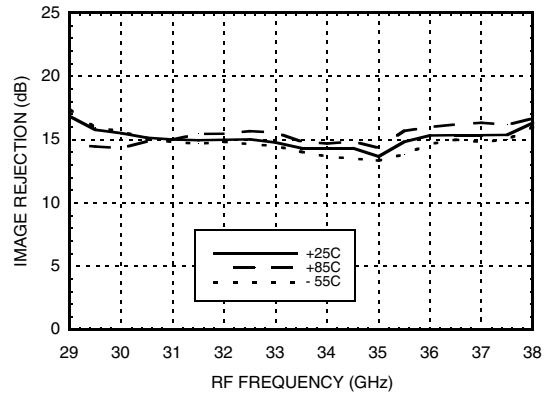

Conversion Gain vs. LO Drive

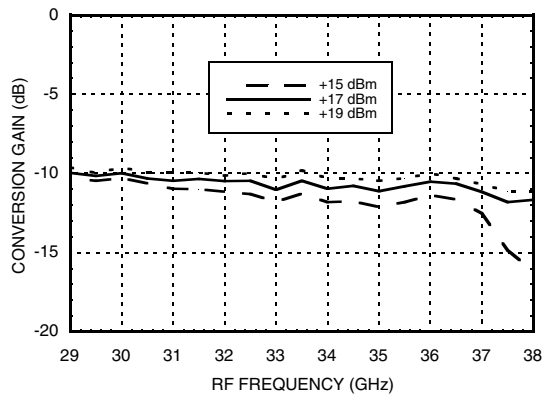

Return Loss

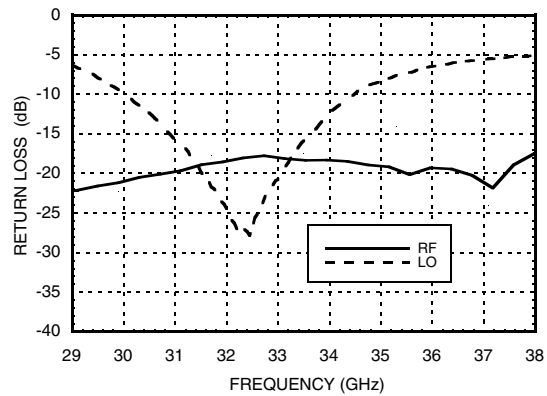

Input P1dB vs. Temperature

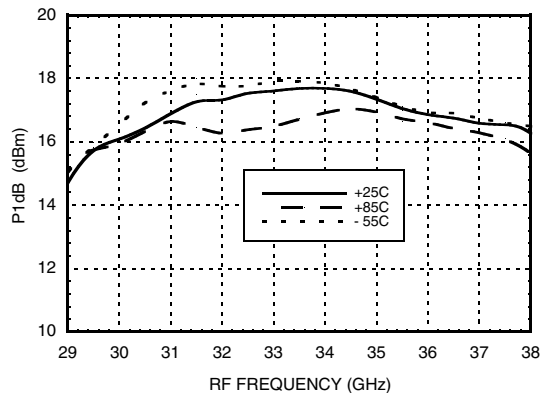

Input IP3 vs. LO Drive

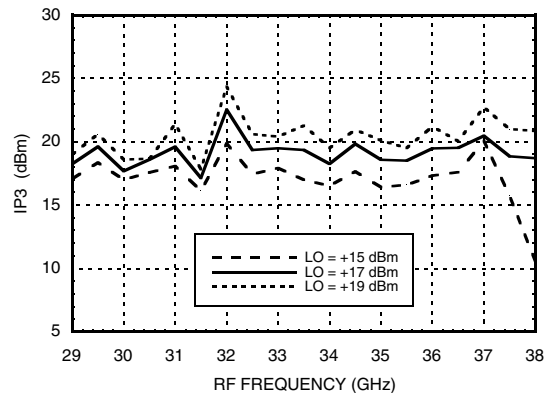

Information furnished by Analog Devices is believed to be accurate and reliable. However, no responsibility is assumed by Analog Devices for its use, nor for any infringements of patents or other rights of third parties that may result from its use. Specifications subject to change without notice. No license is granted by implication or otherwise under any patent or patent rights of Analog Devices. Trademarks and registered trademarks are the property of their respective owners.

For price, delivery, and to place orders: Analog Devices, Inc., One Technology Way, P.O. Box 9106, Norwood, MA 02062-9106 Phone: 781-329-4700 • Order online at www.analog.com Application Support: Phone: 1-800-ANALOG-D



**GaAs MMIC I/Q MIXER MODULE
30 - 38 GHz**

IF1 & IF2 Port Characteristics

Isolations, LO = +19 dBm

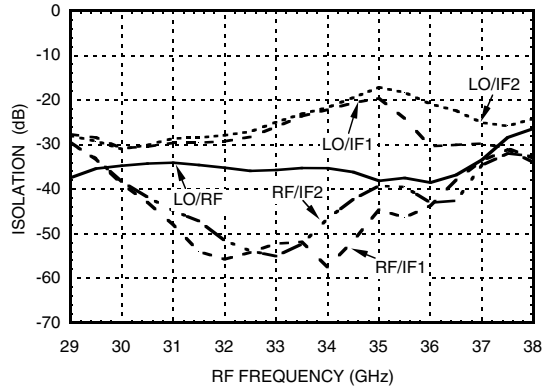

IF Bandwidth*

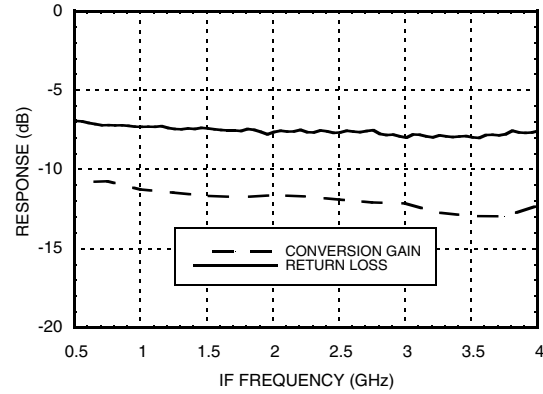

Amplitude Balance vs. LO Drive

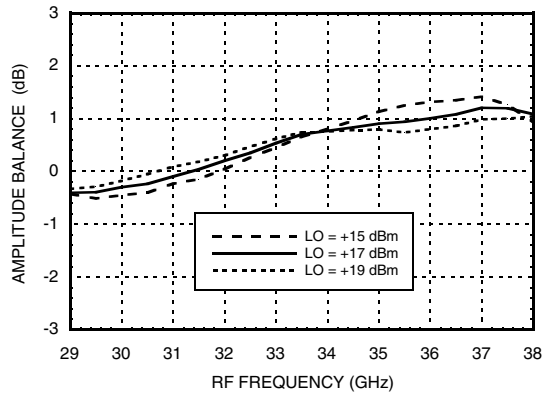

Phase Balance vs. LO Drive

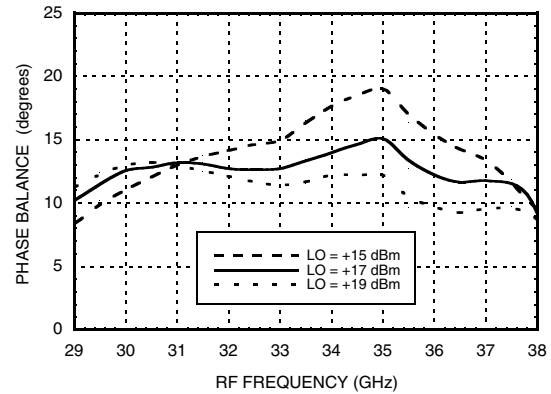

Upconverter Performance Conversion Gain vs. LO Drive

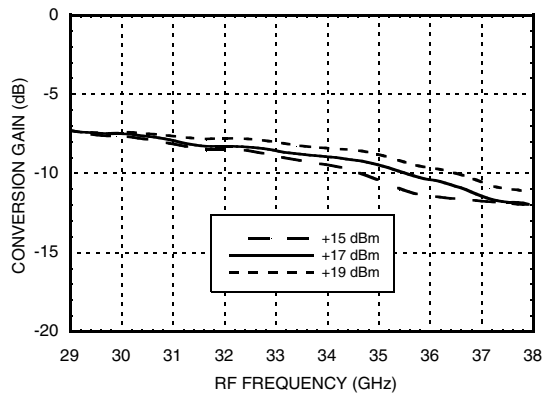

Upconverter Performance Sideband Rejection vs. LO Drive

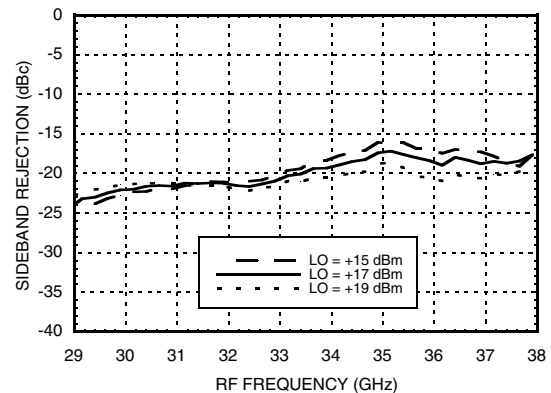

* Conversion gain data taken with external IF 90° hybrid

Information furnished by Analog Devices is believed to be accurate and reliable. However, no responsibility is assumed by Analog Devices for its use, nor for any infringements of patents or other rights of third parties that may result from its use. Specifications subject to change without notice. No license is granted by implication or otherwise under any patent or patent rights of Analog Devices. Trademarks and registered trademarks are the property of their respective owners.

For price, delivery, and to place orders: Analog Devices, Inc., One Technology Way, P.O. Box 9106, Norwood, MA 02062-9106 Phone: 781-329-4700 • Order online at www.analog.com Application Support: Phone: 1-800-ANALOG-D

**GaAs MMIC I/Q MIXER MODULE
30 - 38 GHz**

Absolute Maximum Ratings

RF Input	+19 dBm
IF1 / IF2 Input	+24 dBm
LO Drive	+27 dBm
Storage Temperature	-65 to +150 °C
Operating Temperature	-55 to +85°C

MxN Spurious Outputs

mRF	nLO				
	0	1	2	3	4
0	xx	-12	xx	xx	xx
1	47	0	53	xx	xx
2	xx	62	68	59	xx
3	xx	xx	101	70	90
4	xx	xx	xx	90	104

RF = 35.1 GHz @ -10 dBm
LO = 35 GHz @ +17 dBm
Data taken without IF 90° hybrid
All values in dBc with reference to output power at IF= 100 MHz



**ELECTROSTATIC SENSITIVE DEVICE
OBSERVE HANDLING PRECAUTIONS**

**GaAs MMIC I/Q MIXER MODULE
30 - 38 GHz**



Outline Drawing

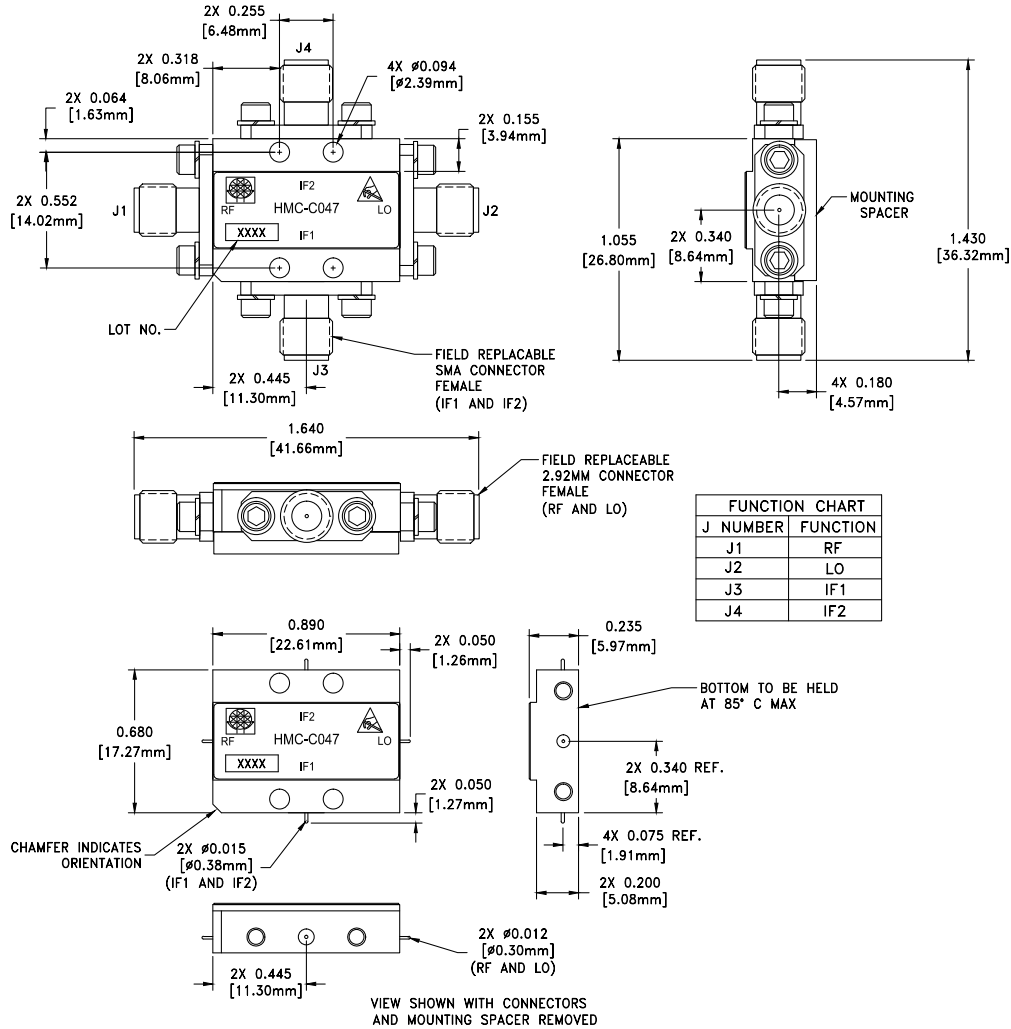

Package Information

Package Type	C-4B
Package Weight ^[1]	20 gms ^[2]
Spacer Weight	2.6 gms ^[2]

[1] Includes the connectors

[2] ±1 gms Tolerance

NOTES:

- 1.0 PACKAGE, LEADS, COVER MATERIAL: KOVAR™
- 2.0 FINISH: GOLD PLATE OVER NICKEL PLATE
- 3.0 MOUNTING SPACER: NICKEL PLATED ALUMINUM.
- 4.0 ALL DIMENSIONS ARE IN INCHES [MILLIMETERS].
- 5.0 TOLERANCES:
 - 5.1 .XX = ±.02
 - 5.2 .XXX = ±.010
- 6.0 FIELD REPLACIBLE SMA CONNECTORS. TENSOLITE 5602-5CCSF OR EQUIVALENT.
- 7.0 TO MOUNT MODULE TO SYSTEM PLATFORM REPLACE 0-80 HARDWARE WITH DESIRED MOUNTING SCREWS.

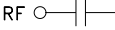
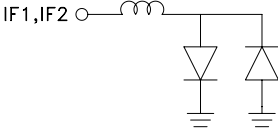

Pin Descriptions

Pin Number	Function	Description	Interface Schematic
1	RF	This pin is AC coupled and matched to 50 Ohms.	RF 
2	IF2	This pin is DC coupled. For applications not requiring operation to DC, this port should be DC blocked externally using a series capacitor whose value has been chosen to pass the necessary IF frequency range. For operation to DC, this pin must not source/sink more than 3mA of current or part non-function and possible part failure will result.	IF1, IF2 
4	IF1		
3	LO	This pin is AC coupled and matched to 50 Ohms.	LO 