



Chipsmall Limited consists of a professional team with an average of over 10 year of expertise in the distribution of electronic components. Based in Hongkong, we have already established firm and mutual-benefit business relationships with customers from,Europe,America and south Asia,supplying obsolete and hard-to-find components to meet their specific needs.

With the principle of “Quality Parts,Customers Priority,Honest Operation,and Considerate Service”,our business mainly focus on the distribution of electronic components. Line cards we deal with include Microchip,ALPS,ROHM,Xilinx,Pulse,ON,Everlight and Freescale. Main products comprise IC,Modules,Potentiometer,IC Socket,Relay,Connector.Our parts cover such applications as commercial,industrial, and automotives areas.

We are looking forward to setting up business relationship with you and hope to provide you with the best service and solution. Let us make a better world for our industry!



Contact us

Tel: +86-755-8981 8866 Fax: +86-755-8427 6832

Email & Skype: info@chipsmall.com Web: www.chipsmall.com

Address: A1208, Overseas Decoration Building, #122 Zhenhua RD., Futian, Shenzhen, China



GaAs MMIC SPDT NON-REFLECTIVE SWITCH, DC - 18 GHz



Typical Applications

The HMC-C058 is ideal for:

- Fiber Optics & Broadband Telecom
- Microwave Radio & VSAT
- Military Radios, Radar, & ECM
- Test Instrumentation

Features

- High Isolation: >65 dB up to 6 GHz
>50 dB up to 18 GHz
- Low Insertion Loss: 2 dB @ 8 GHz
2.8 dB @ 12 GHz
- Fast Switching: 3 ns Rise/Fall Times
- Non-Reflective Design
- Hermetically Sealed Module
- Field Replaceable SMA connectors
- 55 to +85 °C Operating Temperature

General Description

The HMC-C058 is a general purpose broadband high isolation non-reflective GaAs MESFET SPDT switch housed in a miniature hermetic module with field replaceable SMA connectors. Covering DC to 18 GHz, the switch offers high isolation and low insertion loss. The switch features >65 dB isolation up to 6 GHz and >50 dB isolation up to 18 GHz. A CMOS interface allows a single +5V bias voltage at very low DC currents.

Functional Diagram

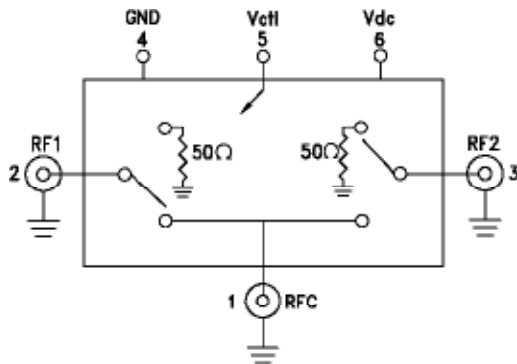

Electrical Specifications, $T_A = +25^\circ C$, With $V_{dc} = +5V$ & $0/+5V$ Control, 50 Ohm System

Parameter	Frequency	Min.	Typ.	Max.	Units
Insertion Loss	DC - 6 GHz		1.6	2.4	dB
	DC - 10 GHz		2.0	2.8	dB
	DC - 18 GHz		3.0	5.5	dB
Isolation	DC - 6 GHz	55	65		dB
	DC - 10 GHz	50	60		dB
	DC - 18 GHz	42	55		dB
Return Loss	"On State"	DC - 6 GHz	17		dB
		DC - 18 GHz	12		dB
Return Loss RF1, RF2	"Off State"	DC - 6 GHz	14		dB
		DC - 18 GHz	17		dB
Input Power for 1 dB Compression	0.5 - 18 GHz	24	27		dBm
Input Third Order Intercept (Two-Tone Input Power= +7 dBm Each Tone)	0.5 - 18 GHz		46		dBm
Switching Characteristics	DC - 18 GHz	tRISE, tFALL (10/90% RF)	3		ns
		tON, tOFF (50% CTL to 10/90% RF)	12		ns
		Switching Transients		12	

Information furnished by Analog Devices is believed to be accurate and reliable. However, no responsibility is assumed by Analog Devices for its use, nor for any infringements of patents or other rights of third parties that may result from its use. Specifications subject to change without notice. No license is granted by implication or otherwise under any patent or patent rights of Analog Devices. Trademarks and registered trademarks are the property of their respective owners.

For price, delivery, and to place orders: Analog Devices, Inc., One Technology Way, P.O. Box 9106, Norwood, MA 02062-9106
Phone: 781-329-4700 • Order online at www.analog.com
Application Support: Phone: 1-800-ANALOG-D

HMC-C058* PRODUCT PAGE QUICK LINKS

Last Content Update: 02/23/2017

[COMPARABLE PARTS](#)

View a parametric search of comparable parts.

[DOCUMENTATION](#)

Data Sheet

- [HMC-C058 Data Sheet](#)

[DESIGN RESOURCES](#)

- [HMC-C058 Material Declaration](#)
- [PCN-PDN Information](#)
- [Quality And Reliability](#)
- [Symbols and Footprints](#)

[DISCUSSIONS](#)

View all HMC-C058 EngineerZone Discussions.

[SAMPLE AND BUY](#)

Visit the product page to see pricing options.

[TECHNICAL SUPPORT](#)

Submit a technical question or find your regional support number.

[DOCUMENT FEEDBACK](#)

Submit feedback for this data sheet.

**GaAs MMIC SPDT NON-REFLECTIVE
SWITCH, DC - 18 GHz**



Insertion Loss

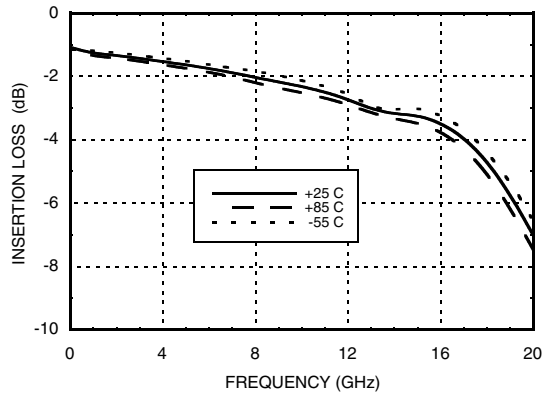

Return Loss RFC

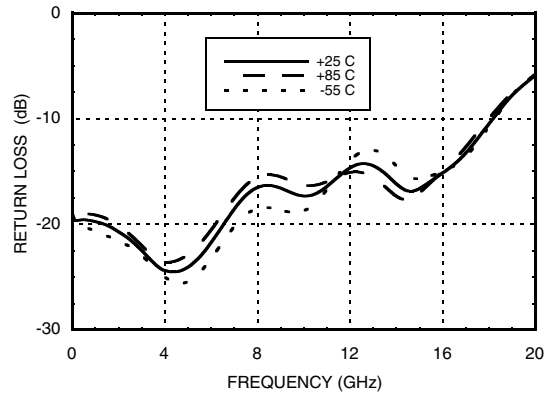

Return Loss RF1, RF2 On

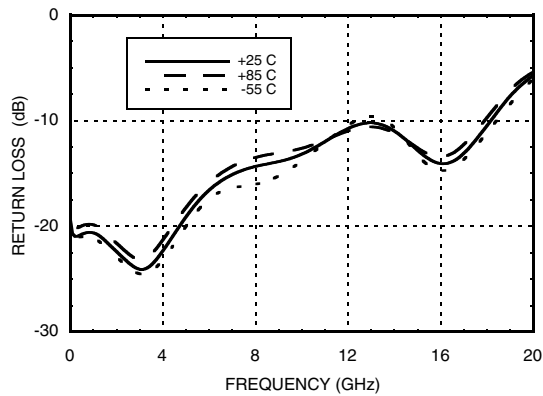

Return Loss RF1, RF2 Off

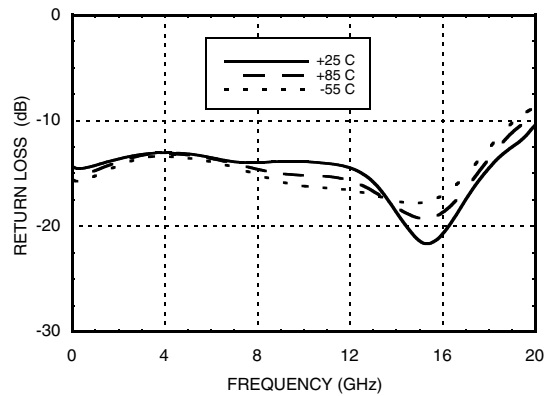

Isolations

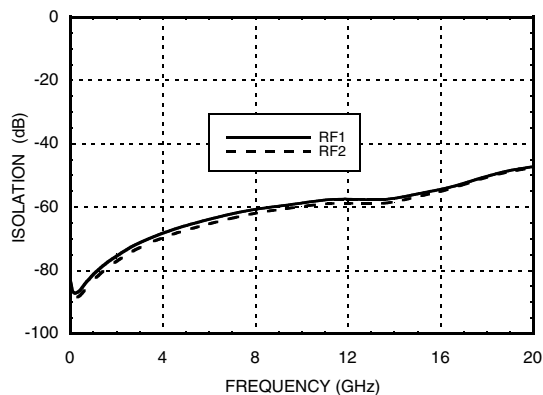

Isolation Between Ports RF1 and RF2

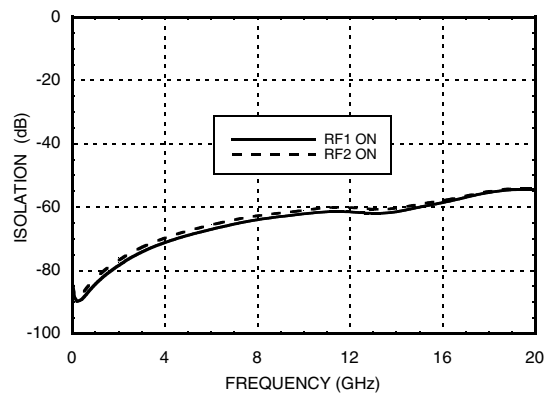

Information furnished by Analog Devices is believed to be accurate and reliable. However, no responsibility is assumed by Analog Devices for its use, nor for any infringements of patents or other rights of third parties that may result from its use. Specifications subject to change without notice. No license is granted by implication or otherwise under any patent or patent rights of Analog Devices. Trademarks and registered trademarks are the property of their respective owners.

For price, delivery, and to place orders: Analog Devices, Inc., One Technology Way, P.O. Box 9106, Norwood, MA 02062-9106 Phone: 781-329-4700 • Order online at www.analog.com Application Support: Phone: 1-800-ANALOG-D

**GaAs MMIC SPDT NON-REFLECTIVE
SWITCH, DC - 18 GHz**



Input P1dB Compression Point

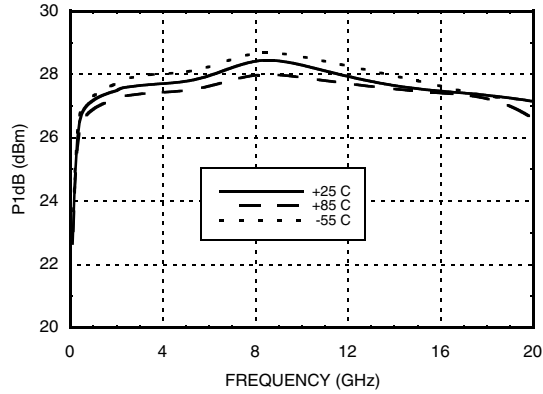

Input Third Order Intercept Point

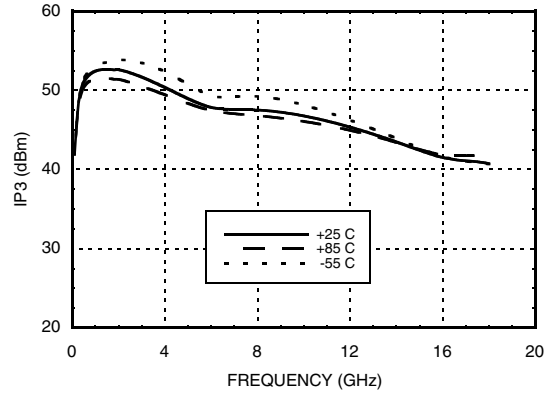

Absolute Maximum Ratings

RF Input Power	+30 dBm
Supply Voltage (Vdc)	+7 V
Control Voltage Range (Vctl)	-0.5V to Vdc +0.5V
Hot Switch Power Level	+27 dBm
Storage Temperature	-65 to +150 °C
Operating Temperature	-55 to +85 °C

Control Voltages

State	Bias Condition
High	+3.5 to Vdc @ 1 mA Typ.
Low	0 to +1.5V @ 20 µA Typ.



**ELECTROSTATIC SENSITIVE DEVICE
OBSERVE HANDLING PRECAUTIONS**

Truth Table

Control Input	Signal Path State	
	RFC to RF1	RFC to RF2
High	On	Off
Low	Off	On

Bias Voltage & Current



Vdc Range = +5 Vdc ± 10%	
Vdc (V)	Idc (Typ.) (mA)
+5.0	1.4

(Bias current increases with switching rate to 15 - 20 mA.)

GaAs MMIC SPDT NON-REFLECTIVE SWITCH, DC - 18 GHz

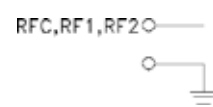

Pin Descriptions

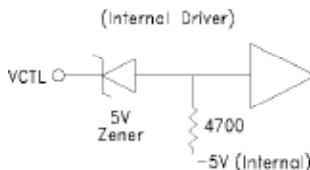
Pin Number	Function	Description	Interface Schematic
1, 2, 3	RFC, RF1, RF2	RF connector, SMA female, field replaceable. These pins are DC coupled and matched to 50 Ohms. DC blocking capacitors are required if external RF line potential is not equal to 0V.	
4	GND	Power supply ground.	
5	Vctl	CMOS interface, control voltages per table. Requires active pullup to +5V (V_{dc}).	
6	Vdc	Supply voltage	

GaAs MMIC SPDT NON-REFLECTIVE SWITCH, DC - 18 GHz



Outline Drawing

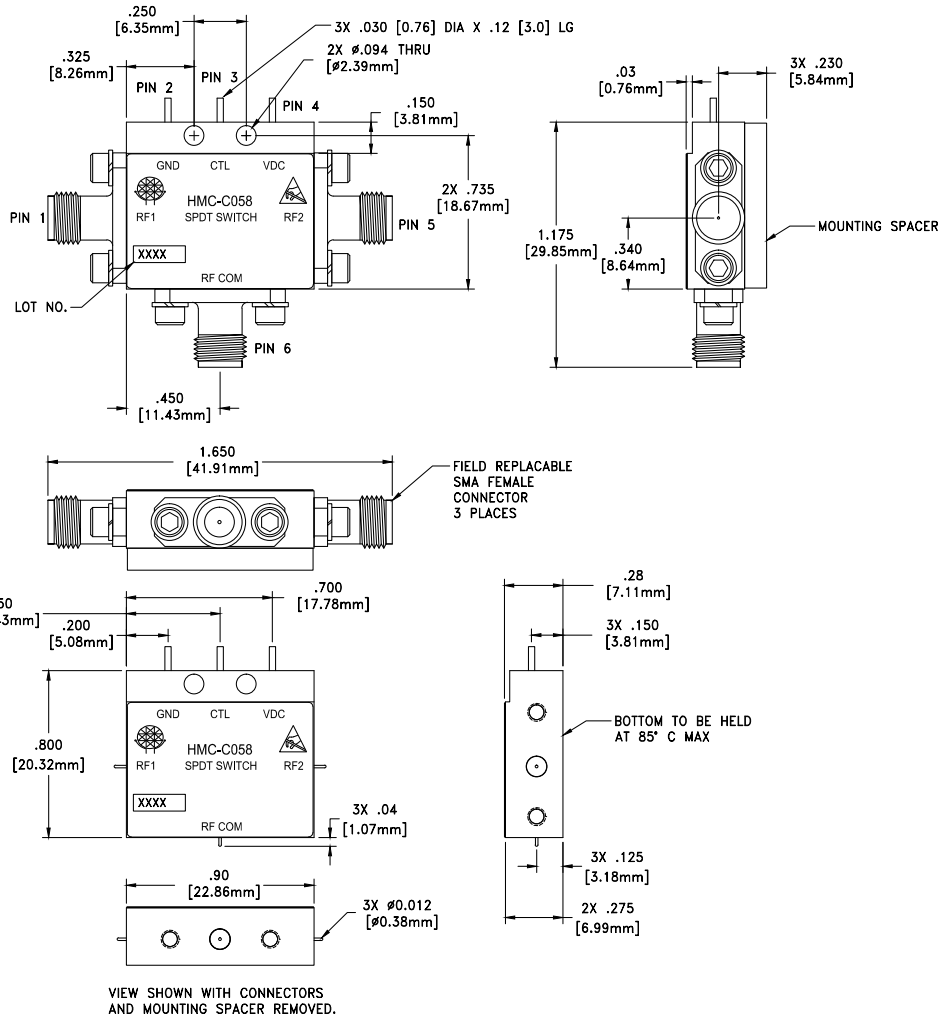

SWITCHES

Package Information

Package Type	C-14
--------------	------

NOTES:

1. PACKAGE, LEADS, COVER MATERIAL: KOVAR™
2. PLATING: ELECTROLYTIC GOLD 50 MICROINCHES MIN., OVER ELECTROLYTIC NICKEL 75 MICROINCHES MIN.
3. SPACER MATERIAL: NICKEL PLATED ALUMINUM
4. DIMENSIONS ARE IN INCHES [MILLIMETERS].
5. TOLERANCES ±0.010 [0.25] UNLESS OTHERWISE SPECIFIED
6. FIELD REPLACEABLE SMA CONNECTORS. TENSOLITE 5602-5CCSF OR EQUIVALENT.

**GaAs MMIC SPDT NON-REFLECTIVE
SWITCH, DC - 18 GHz****Notes:**