



Chipsmall Limited consists of a professional team with an average of over 10 year of expertise in the distribution of electronic components. Based in Hongkong, we have already established firm and mutual-benefit business relationships with customers from,Europe,America and south Asia,supplying obsolete and hard-to-find components to meet their specific needs.

With the principle of “Quality Parts,Customers Priority,Honest Operation,and Considerate Service”,our business mainly focus on the distribution of electronic components. Line cards we deal with include Microchip,ALPS,ROHM,Xilinx,Pulse,ON,Everlight and Freescale. Main products comprise IC,Modules,Potentiometer,IC Socket,Relay,Connector.Our parts cover such applications as commercial,industrial, and automotives areas.

We are looking forward to setting up business relationship with you and hope to provide you with the best service and solution. Let us make a better world for our industry!



Contact us

Tel: +86-755-8981 8866 Fax: +86-755-8427 6832

Email & Skype: info@chipsmall.com Web: www.chipsmall.com

Address: A1208, Overseas Decoration Building, #122 Zhenhua RD., Futian, Shenzhen, China





MicroSynth® INTEGRATED SYNTHESIZER MODULE, 2 - 6 GHz



Typical Applications

The HMC-C083 is ideal for:

- Military Radar, EW & ECM
- Test & Measurement Equipment
- Lab Instrumentation
- Industrial/Medical Equipment

Functional Diagram

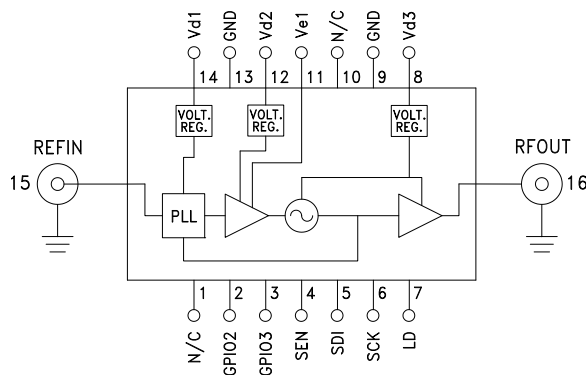

Features

- Extremely Compact, Broadband Synthesizer
- 24-Bit Step Size, 0.6 Hz Resolution
- Auto and Triggered Sweeper Functions
- Integrated Low Noise Voltage Regulators
- Hermetic Module
- Operating Temperature: -40°C to +85°C
- Class 2 ESD Rating (2 kV)

General Description

The HMC-C083 MicroSynth® is a fully integrated broadband synthesizer module that combines high performance SiGe, GaAs pHEMT, and InGaP HBT technologies into one compact hermetic package. The output frequency range is 2 to 6 GHz with an average output power of +17 dBm. In fractional-N mode, the HMC-C083 can realize step sizes as low as 0.6 Hz. The HMC-C083 also features fully integrated low noise regulators and an output buffer amplifier which results in superior pushing and pulling performance. This module has been designed to withstand harsh environments and can be upscrambled to higher military standards upon request.

For theory of operation and register map refer to the MicroSynth® Operating Guide. To view the Operating Guide, please visit www.hittite.com and choose HMC-C083 from the "Search by Part Number" pull down menu.

Electrical Specifications, $T_A = +25^\circ\text{C}$, $V_{d1} = 3.6\text{V}$, $V_{d2} = 20\text{V}$, $V_{d3} = 6\text{V}$, $V_{e1} = -2\text{V}$

Parameter	Min.	Typ.	Max.	Units
Frequency Range		2 - 6		GHz
Power Output	14	17		dBm
Phase Noise @ 100 Hz Offset		-83		dBc/Hz
Phase Noise @ 1 kHz Offset		-88		dBc/Hz
Phase Noise @ 10 kHz Offset		-92		dBc/Hz
Phase Noise @ 100 kHz Offset		-94		dBc/Hz
Phase Noise @ 1 MHz Offset		-122		dBc/Hz
Reference Spur (@ 10 MHz)		-50	-45	dBc
Second Harmonic		-22		dBc
Third Harmonic		-25		dBc
Prescaler Coefficient (M)		1		
Phase Settling Time (<3 degrees), 10 MHz Step		500		µs
Phase Settling Time (<3 degrees), 4 GHz Step		15		ms

Information furnished by Analog Devices is believed to be accurate and reliable. However, no responsibility is assumed by Analog Devices for its use, nor for any infringements of patents or other rights of third parties that may result from its use. Specifications subject to change without notice. No license is granted by implication or otherwise under any patent or patent rights of Analog Devices. Trademarks and registered trademarks are the property of their respective owners.

For price, delivery, and to place orders: Analog Devices, Inc., One Technology Way, P.O. Box 9106, Norwood, MA 02062-9106
Phone: 781-329-4700 • Order online at www.analog.com
Application Support: Phone: 1-800-ANALOG-D

HMC-C083* PRODUCT PAGE QUICK LINKS

Last Content Update: 02/23/2017

COMPARABLE PARTS

View a parametric search of comparable parts.

DOCUMENTATION

Data Sheet

- HMC-C083 Data Sheet

User Guides

- Microsynth® Integrated Hermetic Synthesizer Product & Operating Guide

REFERENCE MATERIALS

Technical Articles

- New MicroSynth™ Integrated Hermetic Synthesizer Module

DESIGN RESOURCES

- HMC-C083 Material Declaration
- PCN-PDN Information
- Quality And Reliability
- Symbols and Footprints

DISCUSSIONS

View all HMC-C083 EngineerZone Discussions.

SAMPLE AND BUY

Visit the product page to see pricing options.

TECHNICAL SUPPORT

Submit a technical question or find your regional support number.

DOCUMENT FEEDBACK

Submit feedback for this data sheet.



MicroSynth® INTEGRATED SYNTHESIZER MODULE, 2 - 6 GHz

Electrical Specifications, (Continued)

Parameter	Min.	Typ.	Max.	Units
Output Return Loss		13		dB
Loop Bandwidth		150		kHz
Reference (comparison) Frequency		10		MHz
Reference Input Power	-6	0	12	dBm
Voltage Supply (Vd1)	3.3	3.6	12	V
Supply Current (Id1)		110	125	mA
Voltage Supply (Vd2)	19	20	20.5	V
Supply Current (Id2)		7	15	mA
Voltage Supply (Vd3)	5.5	6	12	V
Supply Current (Id3)		330	375	mA
Total DC Power Dissipation		2.5	6.5	W
Voltage Supply (Ve1) [1]	-6	-2	375	V
Supply Current (Ve1)		7	15	mA

Output Power vs. Frequency

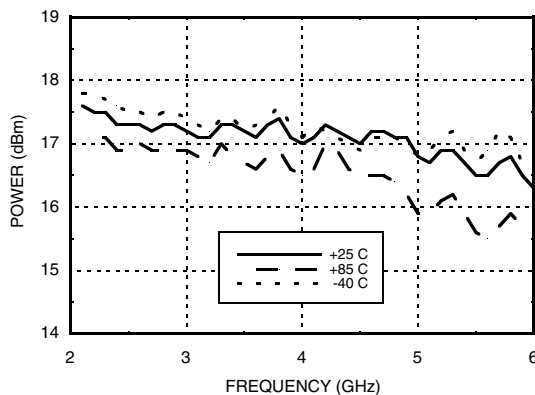

Phase Noise @ 2 GHz, Integer Mode

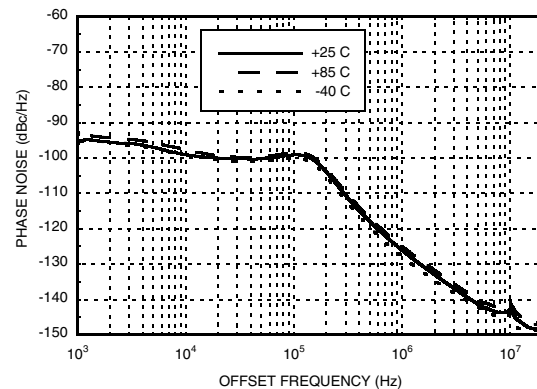

Phase Noise @ 4 GHz, Integer Mode

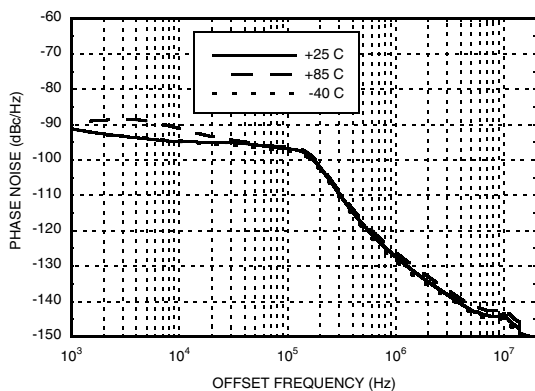

Phase Noise @ 4 GHz Integer vs. Fractional Mode

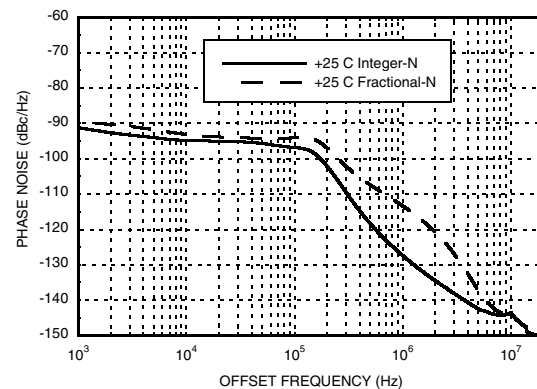

[1] Ve1 can be grounded if operation 2.1 - 6.0 GHz is acceptable



MicroSynth® INTEGRATED SYNTHESIZER MODULE, 2 - 6 GHz

Phase Noise @ 6 GHz, Integer Mode

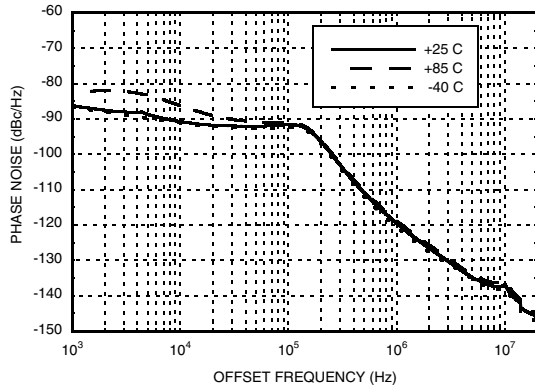

Reference Spur

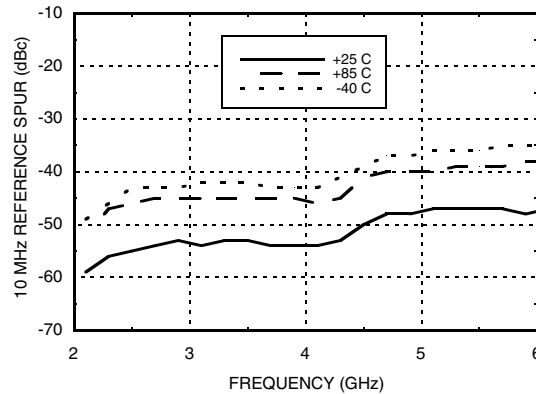

Second Harmonic vs. Frequency

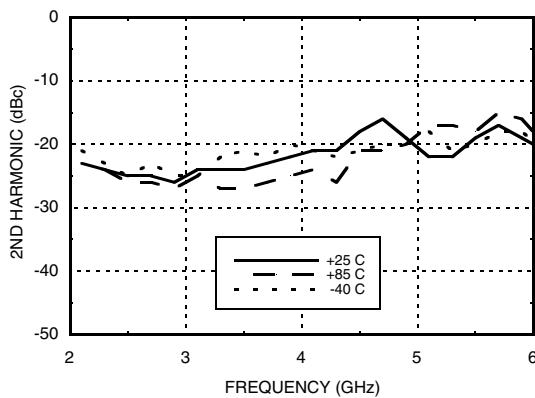

Third Harmonic vs. Frequency

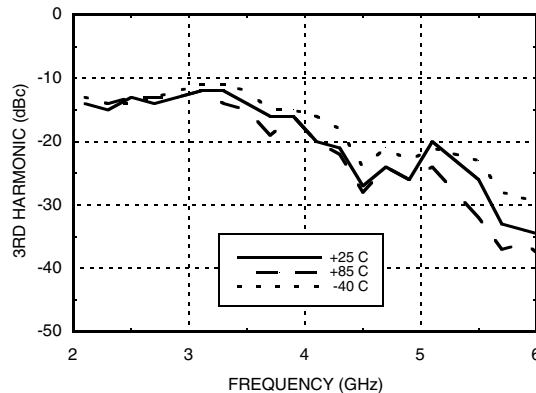

Fractional Spur Levels

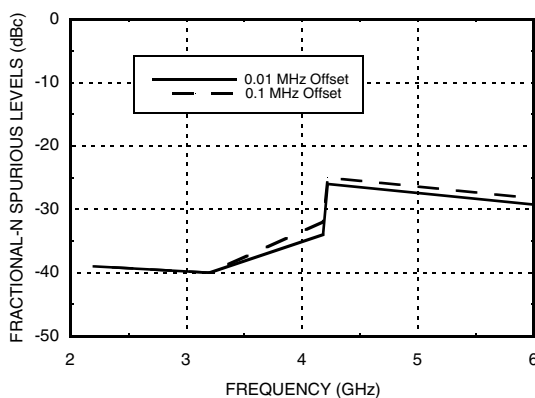

Absolute Maximum Ratings

Vd1	12 V
Vd2	20.5 V
Vd3	12 V
Ve1 (min)	-6 V
Continuous Pdiss (T = 85°C)	6.5 W
Storage Temperature	-55 to +125 °C
Operating Temperature (backside)	-40 to +85 °C
SEN, CLK, SDI, GPIO2, GPIO3, LD	3.6V



**ELECTROSTATIC SENSITIVE DEVICE
OBSERVE HANDLING PRECAUTIONS**

Note that for operation below 4.2 GHz, register 1Bh should be set to 90h. In all other instances, register 1Bh should be set to 80h.

Information furnished by Analog Devices is believed to be accurate and reliable. However, no responsibility is assumed by Analog Devices for its use, nor for any infringements of patents or other rights of third parties that may result from its use. Specifications subject to change without notice. No license is granted by implication or otherwise under any patent or patent rights of Analog Devices. Trademarks and registered trademarks are the property of their respective owners.

For price, delivery, and to place orders: Analog Devices, Inc., One Technology Way, P.O. Box 9106, Norwood, MA 02062-9106
Phone: 781-329-4700 • Order online at www.analog.com
Application Support: Phone: 1-800-ANALOG-D



MicroSynth® INTEGRATED SYNTHESIZER MODULE, 2 - 6 GHz

Outline Drawing

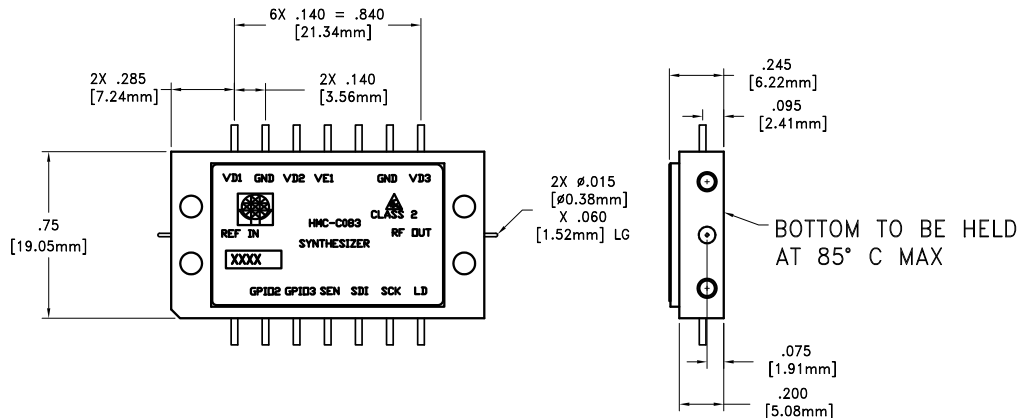
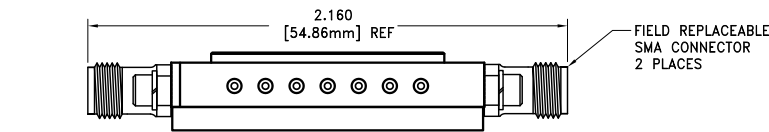
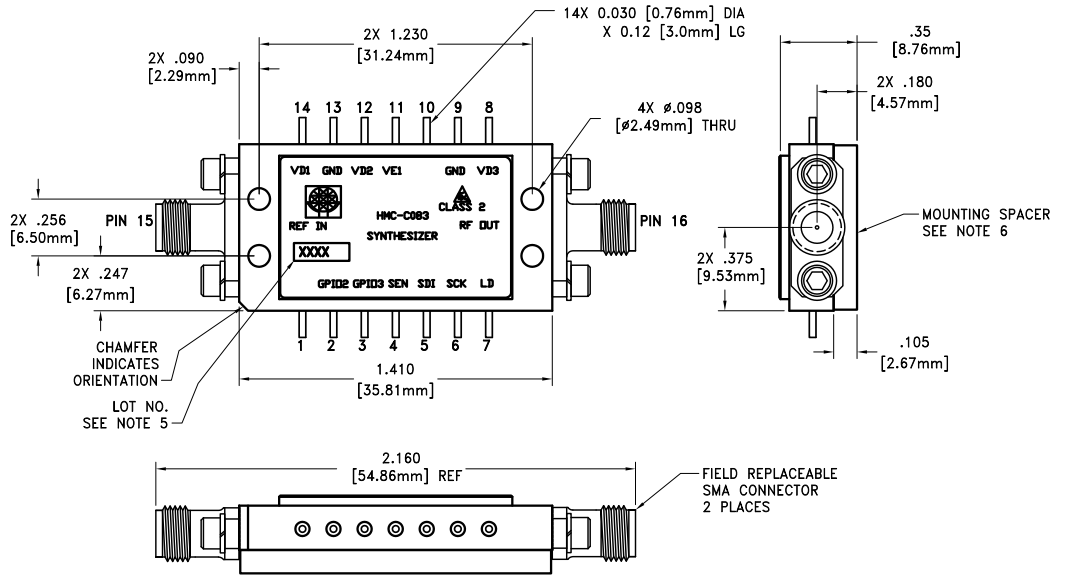

Package Information



Package Type	C-20
Package Weight [1]	16.5g
Spacer Weight	4.6g

[1] Does not include connectors, or mounting hardware

NOTES:

- 1.0 PACKAGE, LEADS, COVER MATERIAL: KOVAR™
- 2.0 FINISH: GOLD PLATE OVER NICKEL PLATE.
- 3.0 ALL DIMENSIONS ARE IN INCHES [MILLIMETERS].
- 4.0 TOLERANCES: UNLESS OTHERWISE SPECIFIED
- 4.1 .XX = ±0.02 [0.51]
.XXX = ±0.010 [0.25]
- 5.0 MARK LOT NUMBER ON 0.080 X 0.250 LABEL WHERE SHOWN WITH 0.030" MIN TEXT HEIGHT.
- 6.0 MOUNTING SPACER ALUMINUM 6061-T6 PER QQ-A-250/11, PLATING 0.0005 - 0.0007 ELECTROLESS NICKEL, SIZE 1.400 X 0.740 X 0.105. SURFACE PLANARITY 0.001 IN/IN ON MOUNTING SURFACES.

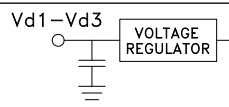
**MicroSynth® INTEGRATED
SYNTHESIZER MODULE, 2 - 6 GHz**
Pin Descriptions

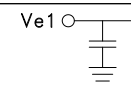
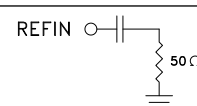
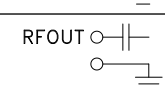
Pin Number	Function	Description	Interface Schematic
1, 10	N/C	The pins are not connected internally; however, all data shown herein was measured with these pins connected to RF/DC ground externally.	
2 - 3	GPIO2, GPIO3	General Purpose I/O with Tristate	See operating guide. [1]
4	SEN	Serial port Enable Input	See operating guide. [1]
5	SDI	Serial port Data input	See operating guide. [1]
6	SCK	Serial port Clock input	See operating guide. [1]
7	LD	Lock Detect	See operating guide. [1]
8, 12, 14	Vd3, Vd2, Vd1	Voltage Supply Pins	
9, 13	GND	These pins must be connected to RF/DC ground.	
11	Ve1	Note: Voltage supply pin may be grounded if operation 2.1 - 6.0 GHz is acceptable.	
15	REFIN	Reference input, 10 MHz nominal, 220 MHz maximum. Note: the comparison frequency (reference freq./R) may not exceed 75 MHz and the module performance is not specified at comparison frequencies other than 10 MHz.	
16	RFOUT	Synthesizer RF output.	

[1] To view the [Operating Guide](#), please visit www.hittite.com and choose HMC-C083 from the "Search by Part Number" pull down menu.

**MicroSynth[®] INTEGRATED
SYNTHESIZER MODULE, 2 - 6 GHz****Notes:**