



Chipsmall Limited consists of a professional team with an average of over 10 year of expertise in the distribution of electronic components. Based in Hongkong, we have already established firm and mutual-benefit business relationships with customers from,Europe,America and south Asia,supplying obsolete and hard-to-find components to meet their specific needs.

With the principle of "Quality Parts,Customers Priority,Honest Operation,and Considerate Service",our business mainly focus on the distribution of electronic components. Line cards we deal with include Microchip,ALPS,ROHM,Xilinx,Pulse,ON,Everlight and Freescale. Main products comprise IC,Modules,Potentiometer,IC Socket,Relay,Connector.Our parts cover such applications as commercial,industrial, and automotives areas.

We are looking forward to setting up business relationship with you and hope to provide you with the best service and solution. Let us make a better world for our industry!



## Contact us

Tel: +86-755-8981 8866 Fax: +86-755-8427 6832

Email & Skype: info@chipsmall.com Web: www.chipsmall.com

Address: A1208, Overseas Decoration Building, #122 Zhenhua RD., Futian, Shenzhen, China



## SUCCESSIVE DETECTION LOG VIDEO AMPLIFIER (SDLVA) 1 - 20 GHz

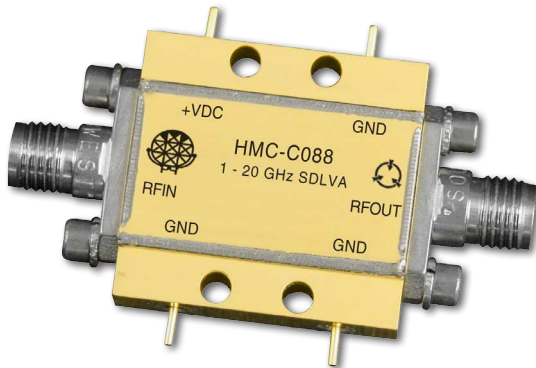

### Typical Applications

The HMC-C088 is ideal for:

- EW, ELINT & IFM Receivers
- DF Radar Systems
- ECM Systems
- Broadband Test & Measurement
- Power Measurement & Control Circuits
- Military & Space Applications

### Functional Diagram

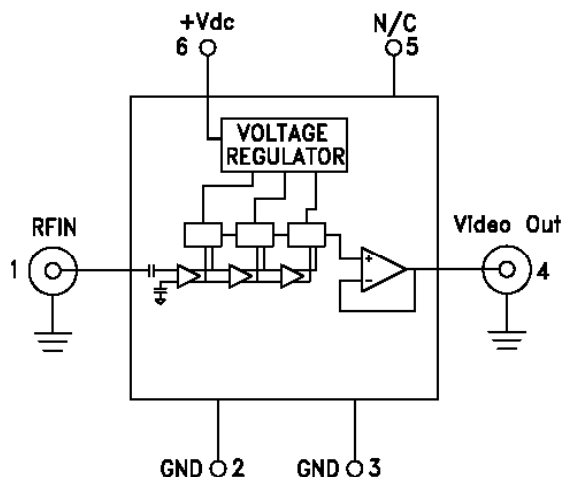

### Electrical Specifications, $T_A = +25^\circ\text{C}$ $V_{dc} = +12\text{V}$

Parameter	Conditions	Typ.	Units
Input Frequency Range		1 - 20	GHz
Frequency Flatness	Pin= -30 dBm	±2	dB
Log Linearity	Pin= -50 dBm to +0 dBm	±1	dBm
Log Linearity over Temperature	-55 to +85° C, Pin= -30 dBm	±1	dB
Minimum Logging Range	to ±3 dB error	-54	dBm
Maximum Logging Range	to ±3 dB error	+5	dBm
Input Return Loss		9	dB
Log Video Minimum Output Voltage		0.9	V

### Features

- 1 to 20 GHz Operation
- High Logging Range: 59 dB
- Output Frequency Flatness: ±2 dB
- Internal Voltage Regulation
- Fast Rise/Fall Times: 2/7 ns
- Hermetically Sealed Module
- Single Positive Supply: +7V to +16V
- 55 °C to +85 °C Operating Temperature

### General Description

The HMC-C088 is a Successive Detection Log Video Amplifier (SDLVA) which operates from 1 to 20 GHz. The HMC-C088 provides a logging range of 59 dB.

This product comes standard with two female SMA field replaceable connectors but can also be used with blind mate SMP connectors or as a drop-in module. The package size measures 1.086 x 0.85 x 0.23" (27.58 x 21.6 x 5.84 mm) making it ideal for environmentally robust applications where space is limited.

The HMC-C088 has an integrated voltage regulator that allows the SDLVA to operate from a single supply between +7 and +16V without any appreciable change in performance.

# HMC-C088\* PRODUCT PAGE QUICK LINKS

Last Content Update: 02/23/2017

---

## [COMPARABLE PARTS](#)

View a parametric search of comparable parts.

## [DOCUMENTATION](#)

### Data Sheet

- [HMC-C088 Data Sheet](#)

## [DESIGN RESOURCES](#)

- [HMC-C088 Material Declaration](#)
- [PCN-PDN Information](#)
- [Quality And Reliability](#)
- [Symbols and Footprints](#)

## [DISCUSSIONS](#)

View all HMC-C088 EngineerZone Discussions.

## [SAMPLE AND BUY](#)

Visit the product page to see pricing options.

## [TECHNICAL SUPPORT](#)

Submit a technical question or find your regional support number.

## [DOCUMENT FEEDBACK](#)

Submit feedback for this data sheet.

---

**SUCCESSIVE DETECTION LOG VIDEO AMPLIFIER (SDLVA)  
1 - 20 GHz**

**Electrical Specifications, (continued)**

Parameter	Conditions	Typ.	Units
Log Video Maximum Output Voltage		1.5	V
Log Video Output Rise Time	Pin = -20 dBm, 10% to 90%	2	ns
Log Video Output Fall Time	Pin = -20 dBm, 90% to 10%	7	ns
Vdc Voltage Range	7 - 16	12	V
Log Video Recovery Time	-50 dBm to 0 dBm	21	ns
Log Video Output Slope		14	mV/dB
Log Video Output Slope Variation over Temperature	@ 10 GHz	5	μV/dB°C
Log Video Propagation Delay		3	ns
Supply Current (I <sub>dc</sub> )		86	mA

**Error Flatness vs. Input Power Over Frequency**

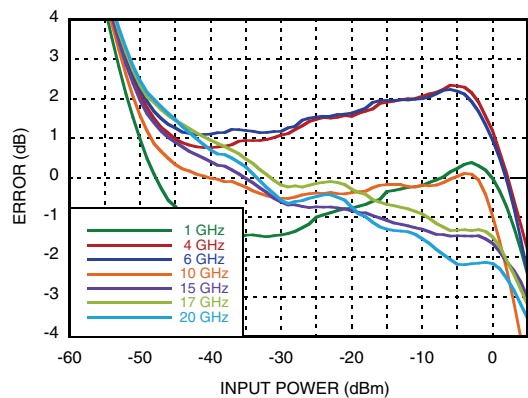

**X-Band Error Flatness vs. Input Power Over Frequency**

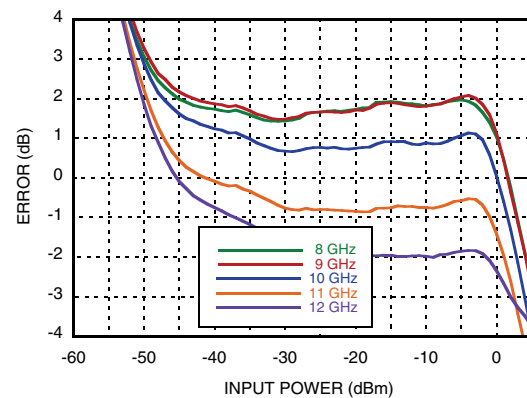

**VIDEO OUT & Error vs. Input Power, Fin= 1 GHz**

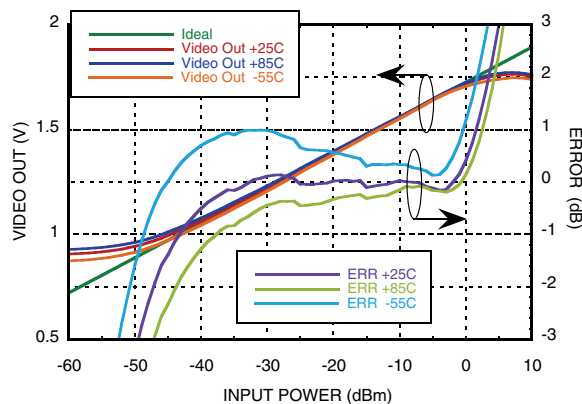

**VIDEO OUT & Error vs. Input Power, Fin= 4 GHz**

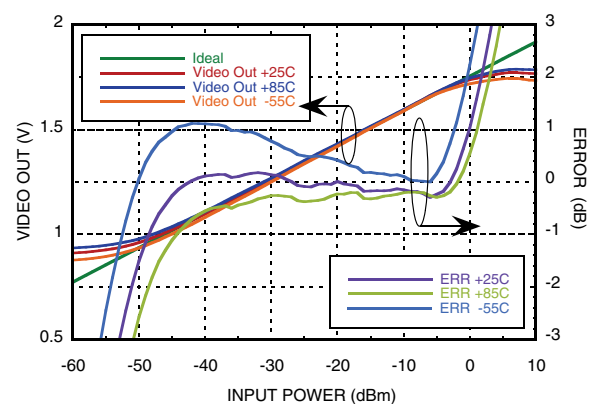

Information furnished by Analog Devices is believed to be accurate and reliable. However, no responsibility is assumed by Analog Devices for its use, nor for any infringements of patents or other rights of third parties that may result from its use. Specifications subject to change without notice. No license is granted by implication or otherwise under any patent or patent rights of Analog Devices. Trademarks and registered trademarks are the property of their respective owners.

For price, delivery, and to place orders: Analog Devices, Inc., One Technology Way, P.O. Box 9106, Norwood, MA 02062-9106 Phone: 781-329-4700 • Order online at [www.analog.com](http://www.analog.com) Application Support: Phone: 1-800-ANALOG-D

**SUCCESSIVE DETECTION LOG VIDEO AMPLIFIER (SDLVA)  
1 - 20 GHz**

SDLVAS - CONNECTORIZED

**VIDEO OUT & Error vs. Input Power,  $F_{in}$  = 6 GHz**

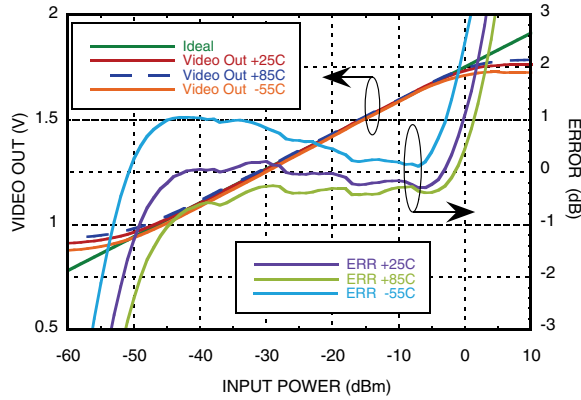

**VIDEO OUT & Error vs. Input Power,  $F_{in}$  = 10 GHz**

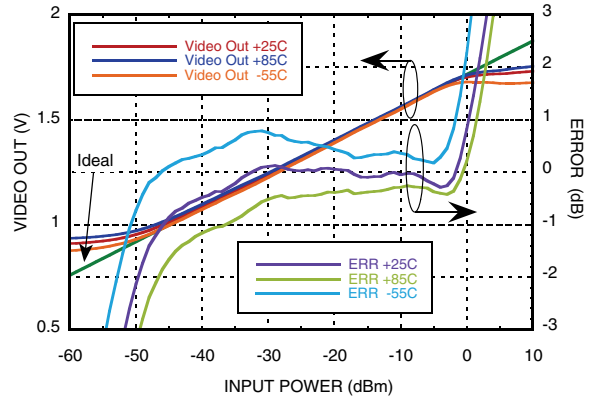

**VIDEO OUT vs. Error vs. Input Power,  $F_{in}$  = 12 GHz**

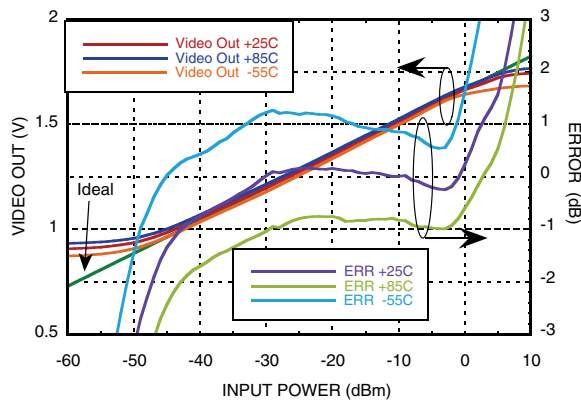

**VIDEO OUT & Error vs. Input Power,  $F_{in}$  = 15 GHz**

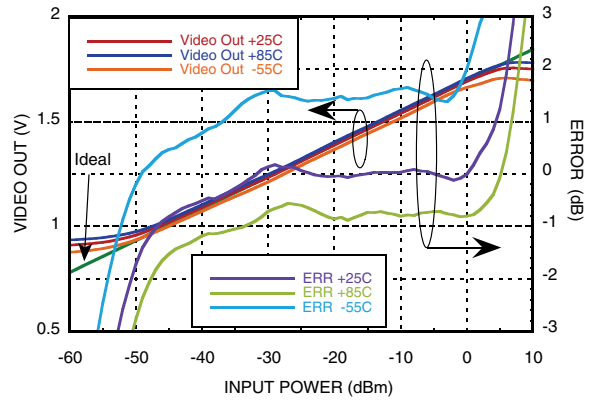

**VIDEO OUT & Error vs. Input Power,  $F_{in}$  = 17 GHz**

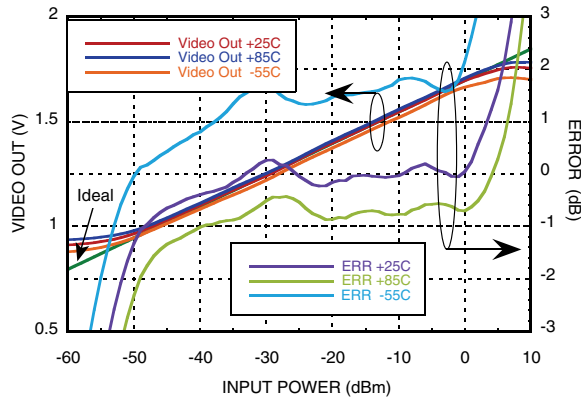

**VIDEO OUT & Error vs. Input Power,  $F_{in}$  = 20 GHz**

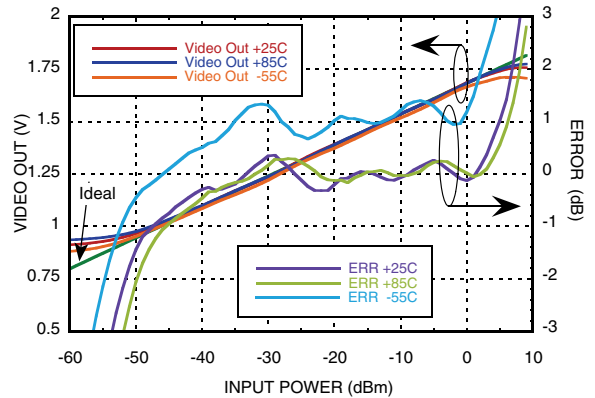

Information furnished by Analog Devices is believed to be accurate and reliable. However, no responsibility is assumed by Analog Devices for its use, nor for any infringements of patents or other rights of third parties that may result from its use. Specifications subject to change without notice. No license is granted by implication or otherwise under any patent or patent rights of Analog Devices. Trademarks and registered trademarks are the property of their respective owners.

For price, delivery, and to place orders: Analog Devices, Inc., One Technology Way, P.O. Box 9106, Norwood, MA 02062-9106 Phone: 781-329-4700 • Order online at [www.analog.com](http://www.analog.com) Application Support: Phone: 1-800-ANALOG-D

## SUCCESSIVE DETECTION LOG VIDEO AMPLIFIER (SDLVA) 1 - 20 GHz

**VIDEO OUT vs. Frequency  
Over Input Power & Temperature**

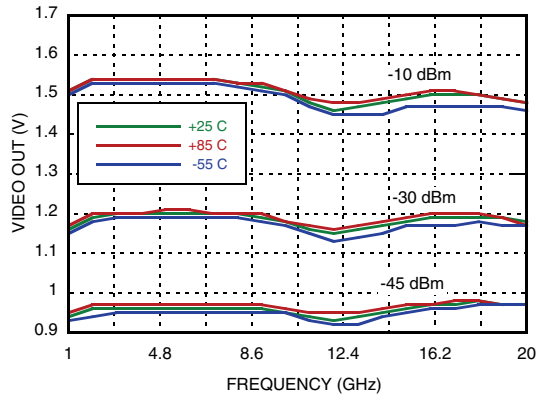

**Input Return Loss vs. Frequency**

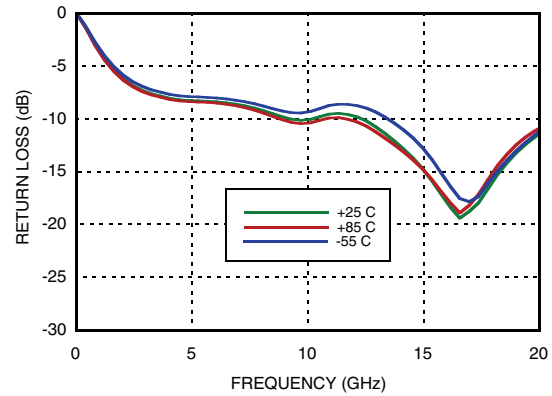

**Rise Time @ 10 GHz @ -20 dBm**

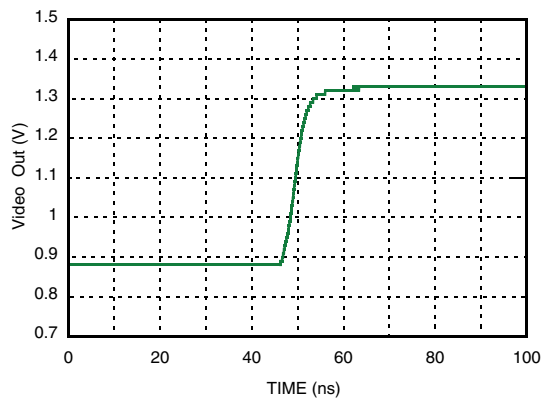

**Fall Time @ 10 GHz @ -20 dBm**

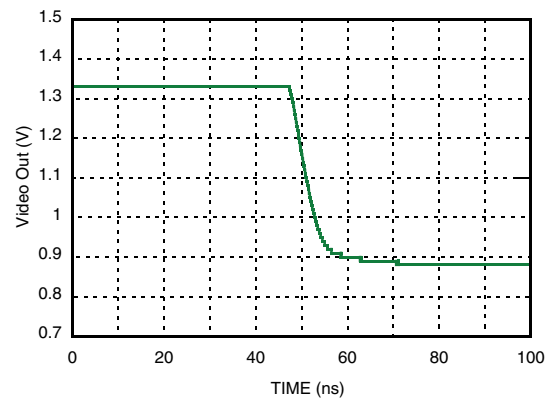

### Absolute Maximum Ratings

I <sub>cc</sub>	100 mA
Input Signal Amplitude	18 dBm
Junction Temperature	125 °C
Continuous P <sub>diss</sub> (T=85°C) Derate 59 mW/°C above 85°C	1.6 W
Thermal Resistance (R <sub>th</sub> ) (junction to package bottom)	17 °C/W
V <sub>dc</sub> Max	+16V
Storage Temperature	-65 to +150 °C
Operating Temperature	-55 to +85 °C
ESD Sensitivity (HBM)	Class 1A



**ELECTROSTATIC SENSITIVE DEVICE  
OBSERVE HANDLING PRECAUTIONS**

**SUCCESSIVE DETECTION LOG VIDEO AMPLIFIER (SDLVA)  
1 - 20 GHz**

**Outline Drawing**

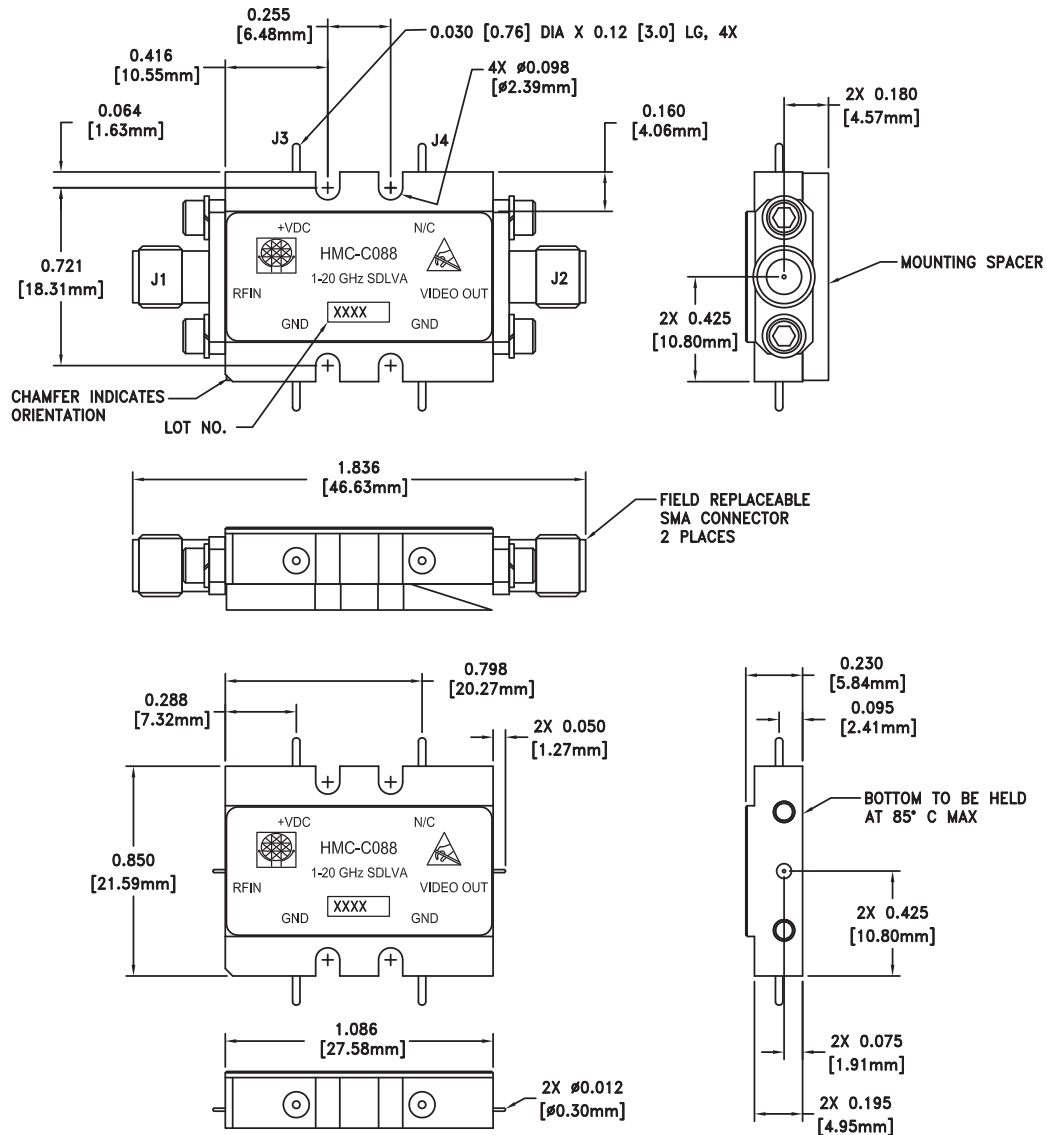

**Package Information**

Package Type	C-10
Package Weight [1]	16.7 gms [2]
Spacer Weight	3.3 gms [2]

[1] Includes the connectors

[2] ±1 gms Tolerance



**NOTES:**

NOTES:

1. PACKAGE, LEADS, COVER MATERIAL: KOVAR™
2. PLATING: GOLD PLATE OVER NICKEL PLATE.
3. MOUNTING SPACER: NICKEL PLATED ALUMINUM.
4. ALL DIMENSIONS ARE IN INCHES [MILLIMETERS].
5. TOLERANCES:
  - 5.1 .XX = ±.02
  - 5.2 .XXX = ±.010
6. MARK LOT NUMBER ON 0.080 X 0.250 LABEL WHERE SHOWN WITH .030" MIN TEXT HEIGHT.
7. MOUNTING SPACER PART NUMBER 126216.

## SUCCESSIVE DETECTION LOG VIDEO AMPLIFIER (SDLVA) 1 - 20 GHz

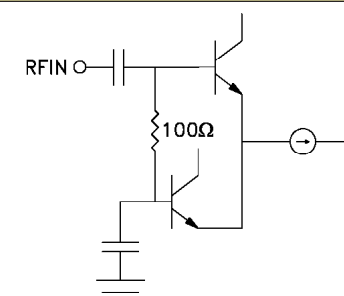
### Pin Descriptions

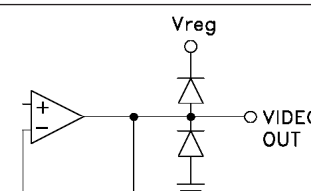
Pin Number	Function	Description	Interface Schematic
1	RFIN	RF Input pin.	
2, 3	GND	These pins must be connected to a high quality RF/DC ground.	
4	VIDEO OUT	Video Out is a voltage that is proportional to the log of the Input Power.	
5	N/C	The pins are not connected internally; however, all data shown herein was measured with these pins connected to RF/DC ground externally.	
6	Vdc	Bias Supply pin.	