



Chipsmall Limited consists of a professional team with an average of over 10 year of expertise in the distribution of electronic components. Based in Hongkong, we have already established firm and mutual-benefit business relationships with customers from,Europe,America and south Asia,supplying obsolete and hard-to-find components to meet their specific needs.

With the principle of "Quality Parts,Customers Priority,Honest Operation,and Considerate Service",our business mainly focus on the distribution of electronic components. Line cards we deal with include Microchip,ALPS,ROHM,Xilinx,Pulse,ON,Everlight and Freescale. Main products comprise IC,Modules,Potentiometer,IC Socket,Relay,Connector.Our parts cover such applications as commercial,industrial, and automotives areas.

We are looking forward to setting up business relationship with you and hope to provide you with the best service and solution. Let us make a better world for our industry!



Contact us

Tel: +86-755-8981 8866 Fax: +86-755-8427 6832

Email & Skype: info@chipsmall.com Web: www.chipsmall.com

Address: A1208, Overseas Decoration Building, #122 Zhenhua RD., Futian, Shenzhen, China



GaAs MMIC I/Q DOWNCONVERTER 27 - 34 GHz



Typical Applications

The HMC1065LP4E is ideal for:

- Point-to-Point and Point-to-Multi-Point Radios
- Satellite Communications
- Sensors

Features

- Conversion Gain: 13 dB
- Image Rejection: 17 dBc
- Input Third-Order Intercept (IP3): -2 dBm
- LO Drive Range: -4 dBm to +4 dBm
- 24 Lead 4 mm x 4 mm SMT Package

Functional Diagram

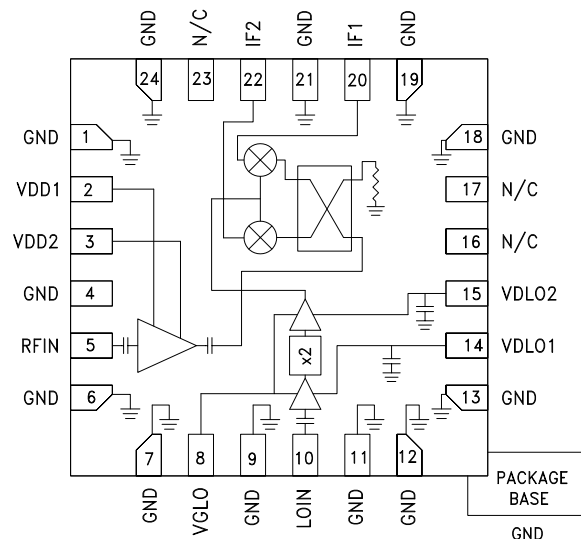

General Description

The HMC1065LP4E is a compact GaAs MMIC Image Reject Low Noise Converter in a leadless RoHS compliant SMT package. This device provides a small signal conversion gain of 13 dB with 17 dBc of image rejection and 2 dBm of Input IP3. The HMC1065LP4E utilizes an RF LNA followed by an I/Q mixer which is driven by an active x2 multiplier. IF1 and IF2 mixer outputs are provided and an external 90° hybrid is needed to select the required sideband. The I/Q mixer topology reduces the need for filtering of the unwanted sideband. The HMC1065LP4E is a much smaller alternative to hybrid style image reject downconverter assemblies and it eliminates the need for wire bonding by allowing the use of surface mount manufacturing techniques.

Electrical Specifications,

$T_A = +25^\circ\text{C}$, $IF = 2000\text{ MHz}$, $LO = +2\text{ dBm}$, $VDLO1 = VDLO2 = 3\text{ V}$, $VDD1 = VDD2 = 3\text{ V}$, **USB** ^[1]

Parameter	Min.	Typ.	Max.	Units
RF Frequency Range	27		34	GHz
LO Frequency Range	11.5		19	GHz
IF Frequency Range	DC		4	GHz
LO Drive Range	-4		+4	dBm
Conversion Gain	9	12		dB
Noise Figure		3		dB
Image Rejection	12	17		dBc
Input Power for 1 dB Compression (P1dB)		-9		dBm
Input Third-Order Intercept (IIP3)		-2		dBm
Output Third-Order Intercept (OIP3)		14		dBm
2x LO / RF Isolation	35	45		dB
2x LO / IF Isolation		20		dB
Amplitude Balance ^[2]		-1		dB
Phase Balance ^[2]		7		deg
Supply Current (IDLO) ^[3]		150		mA
Supply Current (IDD)		90		mA

[1] All measurements performed with upper sideband selected and external 90° hybrid at the IF ports, unless otherwise noted.

[2] Data taken without external 90° hybrid, IF = 1000 MHz.

[3] Adjust VGLO1 and VGLO2 between -2 V and 0 V to achieve total quiescent current (IDLO1 + IDLO2) = 150 mA.

HMC1065* PRODUCT PAGE QUICK LINKS

Last Content Update: 02/23/2017

COMPARABLE PARTS

View a parametric search of comparable parts.

EVALUATION KITS

- HMC1065LP4 Evaluation Board

DOCUMENTATION

Data Sheet

- HMC1065: GaAs MMIC I/Q Downconverter 27 - 34 GHz Data Sheet

REFERENCE MATERIALS

Quality Documentation

- Package/Assembly Qualification Test Report: LP4, LP4B, LP4C, LP4K (QTR: 2013-00487 REV: 04)
- Semiconductor Qualification Test Report: PHEMT-L (QTR: 2013-00266)

DESIGN RESOURCES

- HMC1065 Material Declaration
- PCN-PDN Information
- Quality And Reliability
- Symbols and Footprints

DISCUSSIONS

View all HMC1065 EngineerZone Discussions.

SAMPLE AND BUY

Visit the product page to see pricing options.

TECHNICAL SUPPORT

Submit a technical question or find your regional support number.

DOCUMENT FEEDBACK

Submit feedback for this data sheet.



**GaAs MMIC I/Q DOWNCONVERTER
27 - 34 GHz**

Data Taken as SSB Downconverter with External IF 90° Hybrid, IF = 2000 MHz

Conversion Gain vs. Temperature, USB

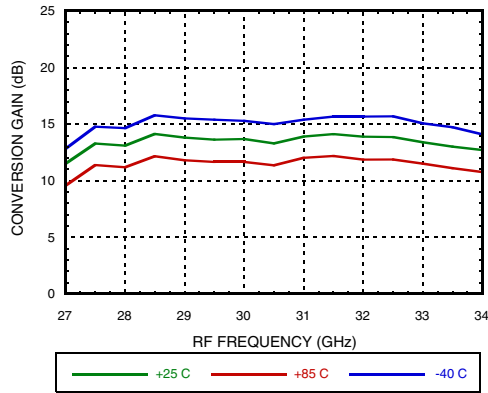

Conversion Gain vs. LO Drive, USB

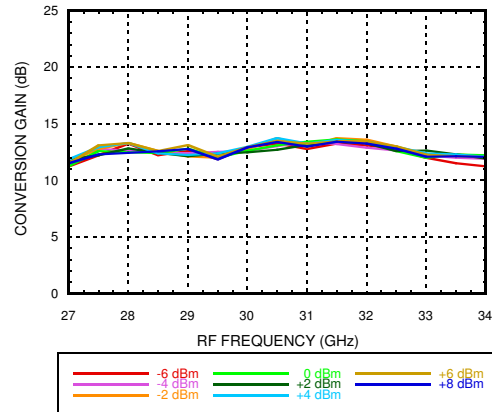

RF Return Loss vs. Temperature

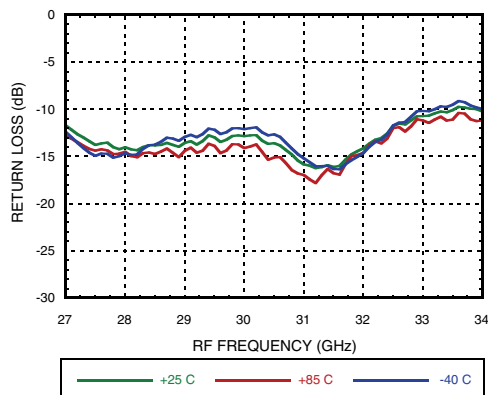

LO Return Loss vs. Temperature

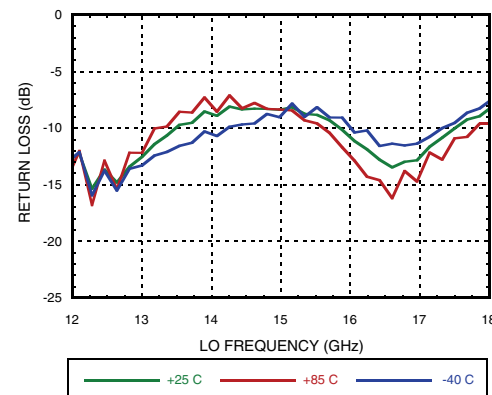

IF Return Loss [1]

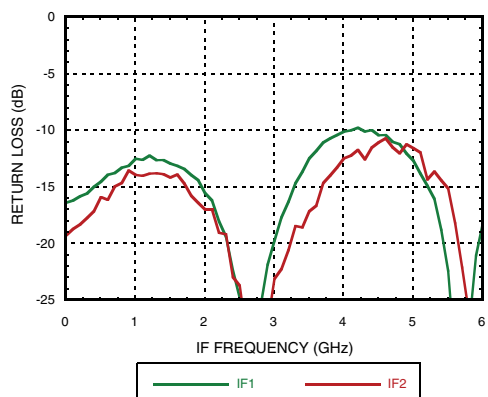
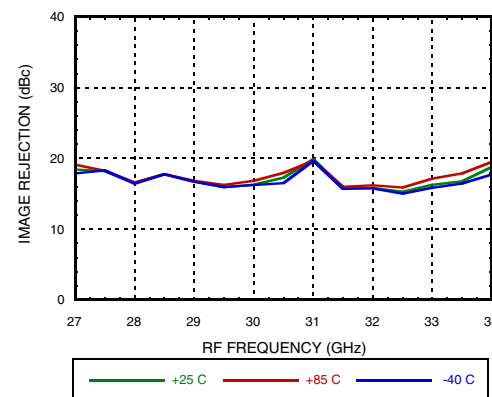

Image Rejection vs. Temperature, USB



[1] Data taken without external IF 90° hybrid

**GaAs MMIC I/Q DOWNCONVERTER
27 - 34 GHz**



Data Taken as SSB Downconverter with External IF 90° Hybrid, IF = 2000 MHz

LO Isolation [1]

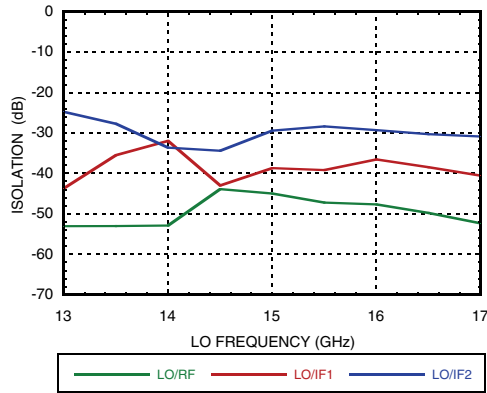

2x LO Isolation [1]

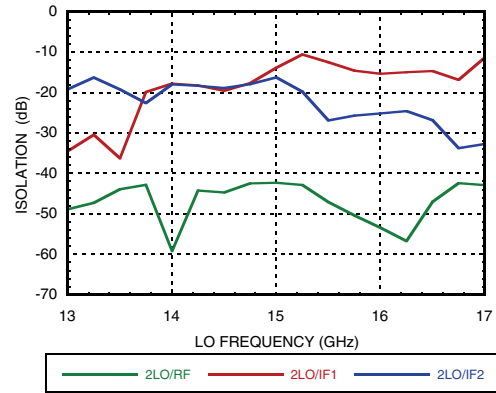

Input P1dB vs. Temperature, USB

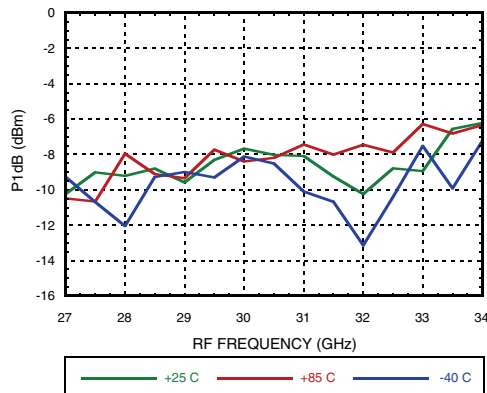

Input IP3 vs. Temperature, USB

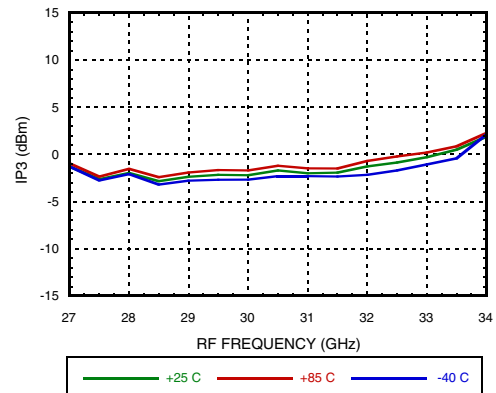

Input IP3 vs. LO Drive, USB

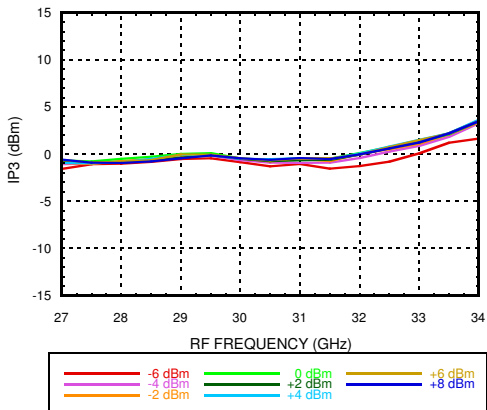

Output IP3 vs. Temperature, USB

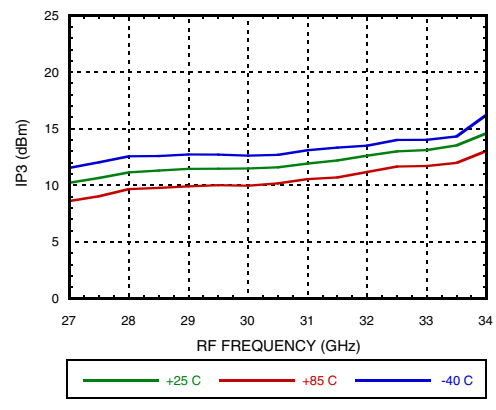

[1] Data taken without external IF 90° hybrid



GaAs MMIC I/Q DOWNCONVERTER
27 - 34 GHz

Data Taken as SSB Downconverter with External IF 90° Hybrid, IF = 2000 MHz

Output IP3 vs. LO Drive, USB

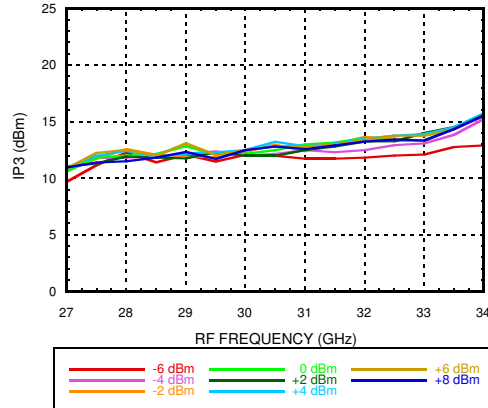

Noise Figure vs. Temperature, USB

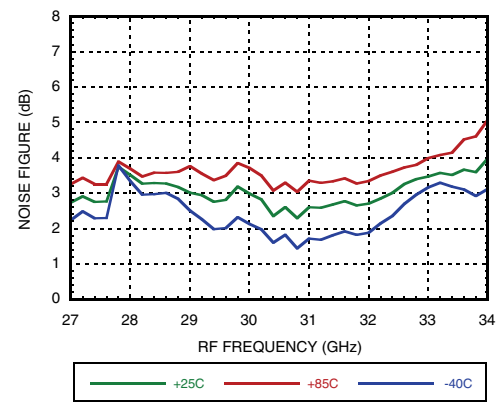

IF Bandwidth [1]

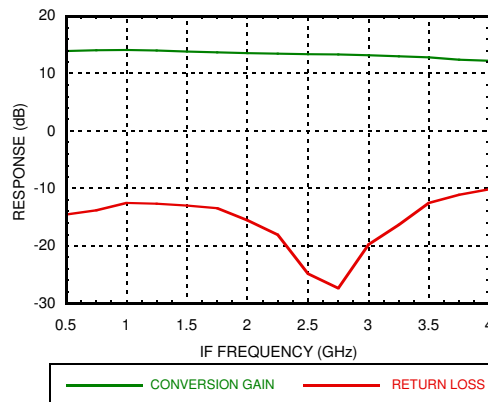

Amplitude Balance vs. LO Drive [1] [2]

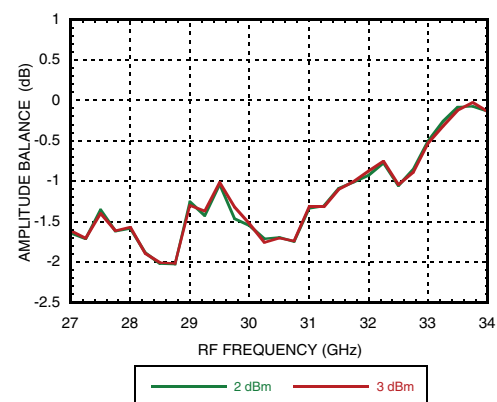

Phase Balance vs. LO Drive [1] [2]

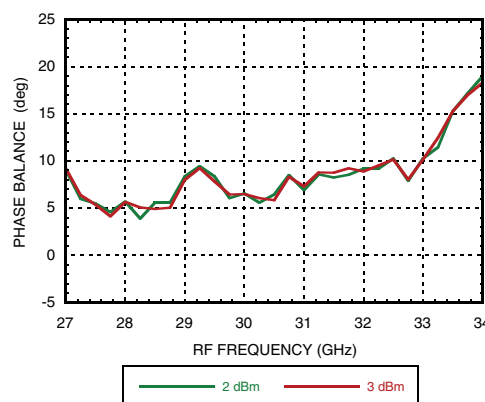

[1] Data taken without external 90° hybrid.
[2] Data taken with IF = 1000MHz.



**GaAs MMIC I/Q DOWNCONVERTER
27 - 34 GHz**

Data Taken as SSB Downconverter with External IF 90° Hybrid, IF = 2000 MHz

Conversion Gain vs. Temperature, LSB

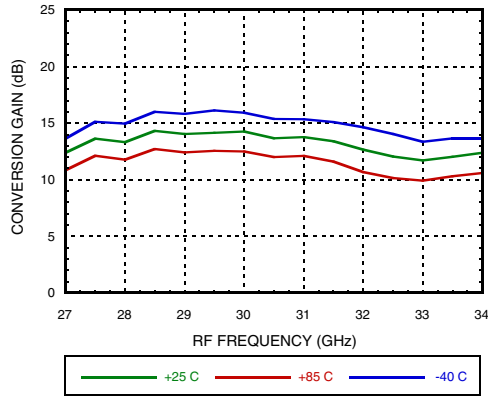

Conversion Gain vs. LO Drive, LSB

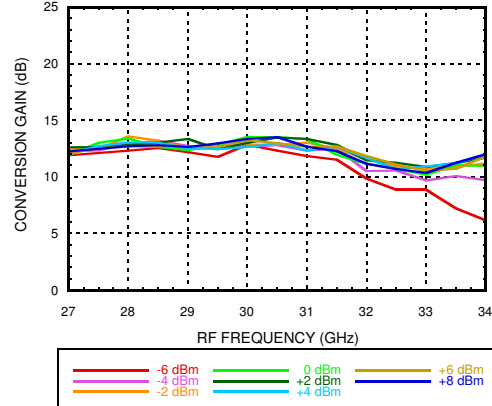
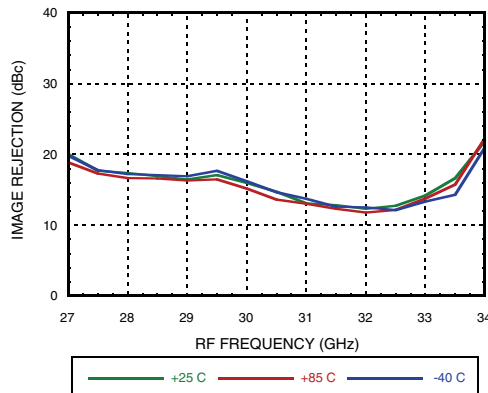
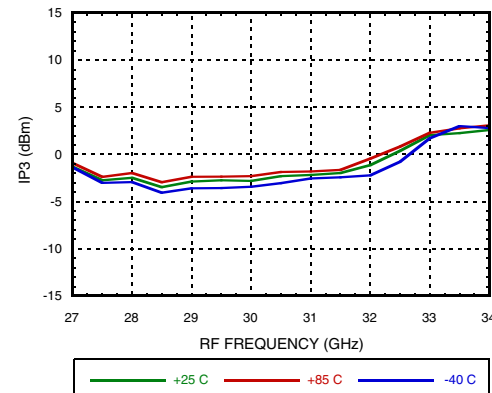

Image Rejection vs. Temperature, LSB



Input IP3 vs. Temperature, LSB



Input IP3 vs. LO Drive, LSB

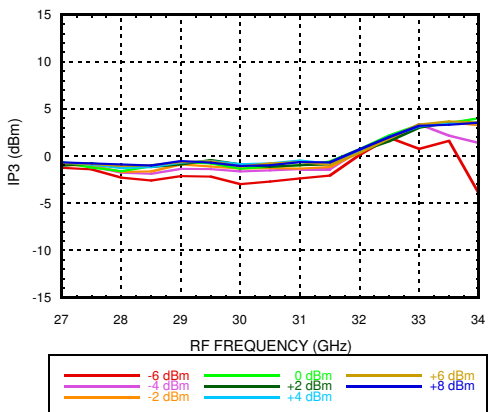

Output IP3 vs. Temperature, LSB

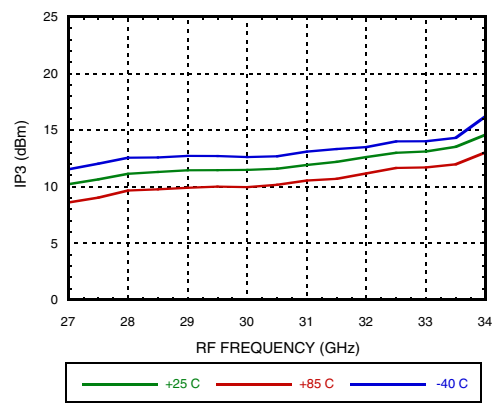

Information furnished by Analog Devices is believed to be accurate and reliable. However, no responsibility is assumed by Analog Devices for its use, nor for any infringements of patents or other rights of third parties that may result from its use. Specifications subject to change without notice. No license is granted by implication or otherwise under any patent or patent rights of Analog Devices. Trademarks and registered trademarks are the property of their respective owners.

For price, delivery, and to place orders: Analog Devices, Inc., One Technology Way, P.O. Box 9106, Norwood, MA 02062-9106 Phone: 781-329-4700 • Order online at www.analog.com Application Support: Phone: 1-800-ANALOG-D



**GaAs MMIC I/Q DOWNCONVERTER
27 - 34 GHz**

**Data Taken as SSB Downconverter with External IF 90° Hybrid, IF = 2000 MHz
Output IP3 vs. LO Drive, LSB**

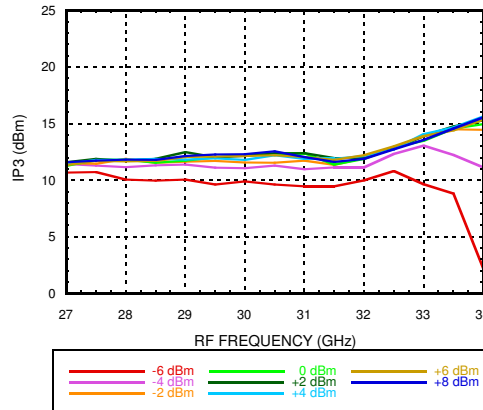

Data Taken as SSB Downconverter with External IF 90° Hybrid, IF = 1000 MHz

Conversion Gain vs. Temperature, USB

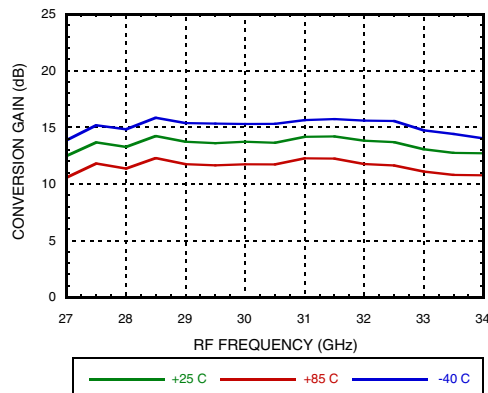

Conversion Gain vs. LO Drive, USB

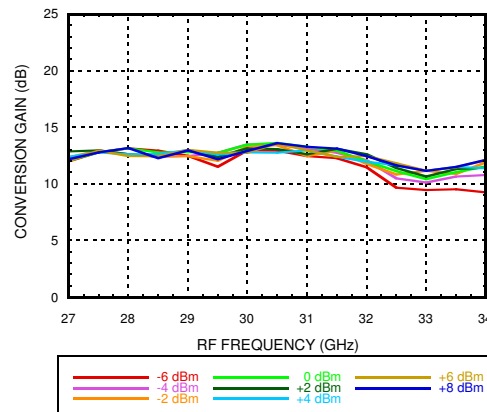
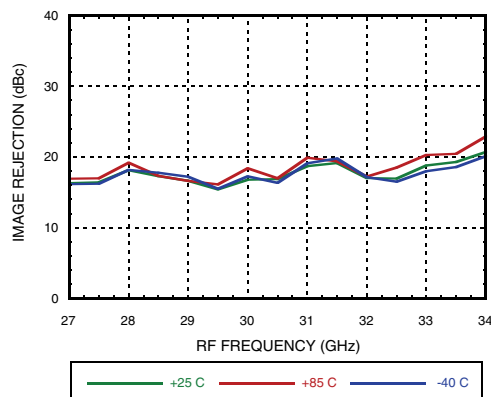
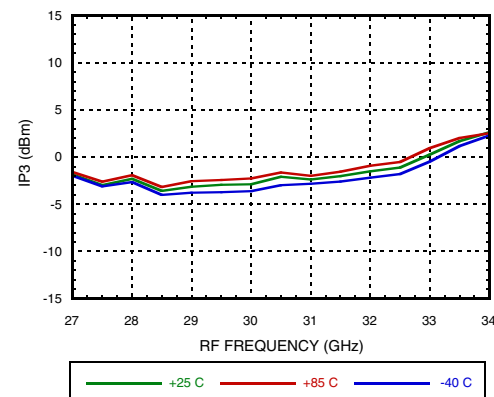

Image Rejection vs. Temperature, USB



Input IP3 vs. Temperature, USB



Information furnished by Analog Devices is believed to be accurate and reliable. However, no responsibility is assumed by Analog Devices for its use, nor for any infringements of patents or other rights of third parties that may result from its use. Specifications subject to change without notice. No license is granted by implication or otherwise under any patent or patent rights of Analog Devices. Trademarks and registered trademarks are the property of their respective owners.

For price, delivery, and to place orders: Analog Devices, Inc., One Technology Way, P.O. Box 9106, Norwood, MA 02062-9106 Phone: 781-329-4700 • Order online at www.analog.com Application Support: Phone: 1-800-ANALOG-D

**GaAs MMIC I/Q DOWNCONVERTER
27 - 34 GHz**



Data Taken as SSB Downconverter with External IF 90° Hybrid, IF = 1000 MHz
Input IP3 vs. LO Drive, USB **Output IP3 vs. Temperature, USB**

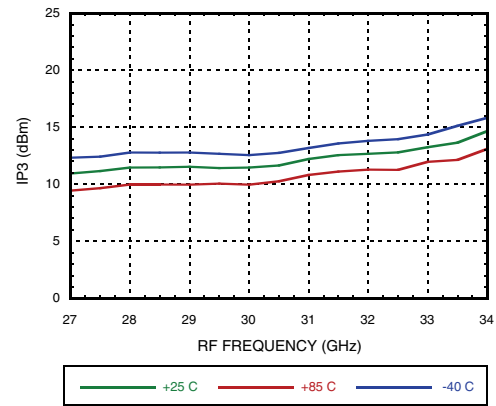
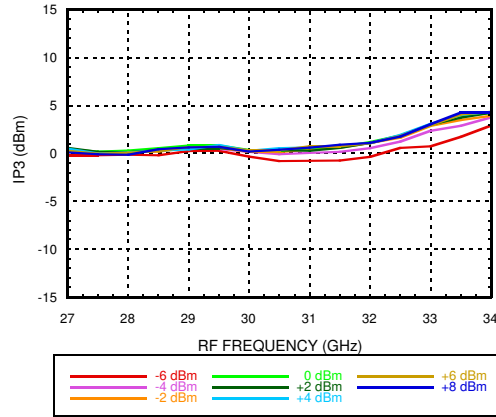

Output IP3 vs. LO Drive, USB

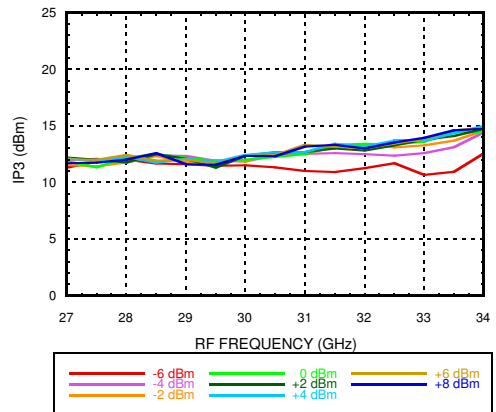

Noise Figure vs. Temperature, USB

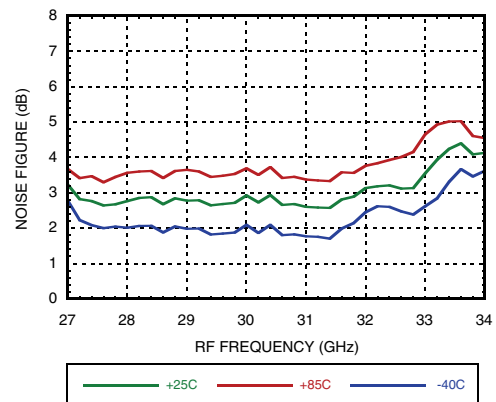

Conversion Gain vs. Temperature, LSB

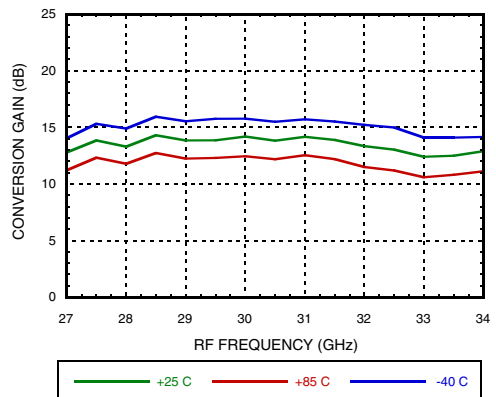

Conversion Gain vs. LO Drive, LSB

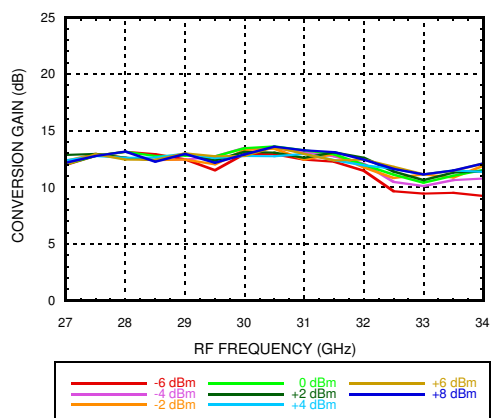

Information furnished by Analog Devices is believed to be accurate and reliable. However, no responsibility is assumed by Analog Devices for its use, nor for any infringements of patents or other rights of third parties that may result from its use. Specifications subject to change without notice. No license is granted by implication or otherwise under any patent or patent rights of Analog Devices. Trademarks and registered trademarks are the property of their respective owners.

For price, delivery, and to place orders: Analog Devices, Inc., One Technology Way, P.O. Box 9106, Norwood, MA 02062-9106 Phone: 781-329-4700 • Order online at www.analog.com Application Support: Phone: 1-800-ANALOG-D



**GaAs MMIC I/Q DOWNCONVERTER
27 - 34 GHz**

Data Taken as SSB Downconverter with External IF 90° Hybrid, IF = 1000 MHz

Image Rejection vs. Temperature, LSB

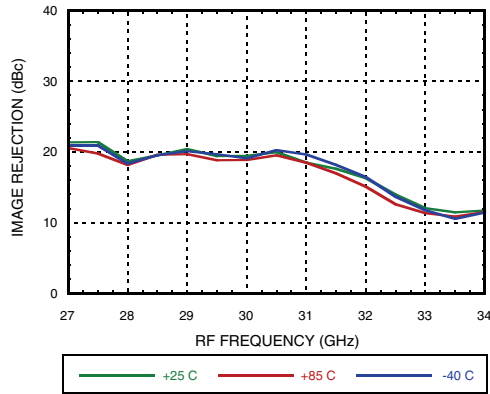

Input IP3 vs. Temperature, LSB

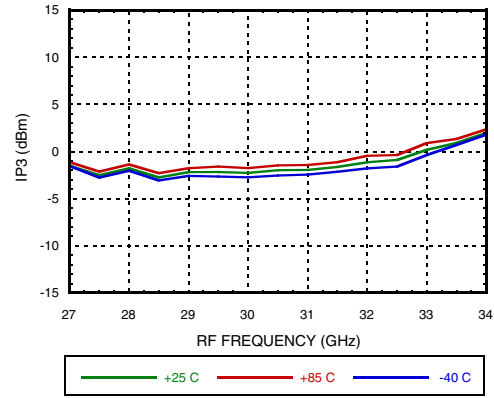

Input IP3 vs. LO Drive LSB

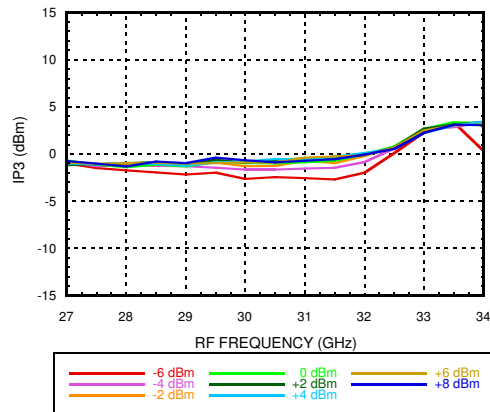

Output IP3 vs. Temperature, LSB

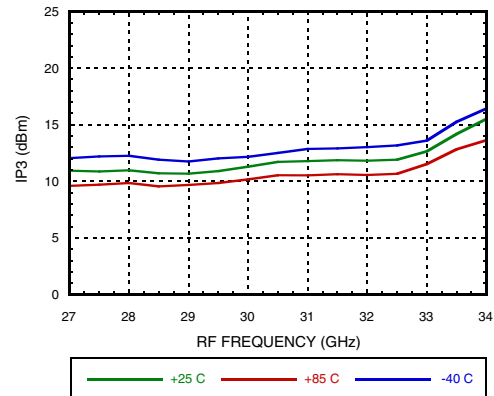

Output IP3 vs. LO Drive, LSB

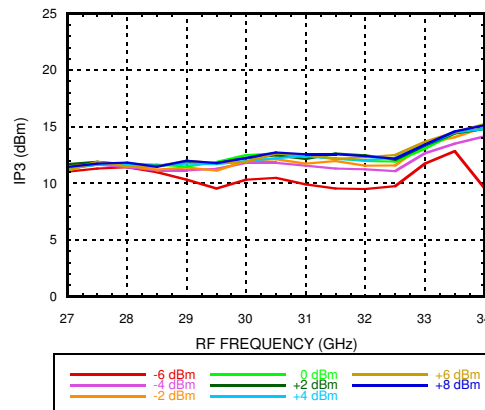

Information furnished by Analog Devices is believed to be accurate and reliable. However, no responsibility is assumed by Analog Devices for its use, nor for any infringements of patents or other rights of third parties that may result from its use. Specifications subject to change without notice. No license is granted by implication or otherwise under any patent or patent rights of Analog Devices. Trademarks and registered trademarks are the property of their respective owners.

For price, delivery, and to place orders: Analog Devices, Inc., One Technology Way, P.O. Box 9106, Norwood, MA 02062-9106 Phone: 781-329-4700 • Order online at www.analog.com Application Support: Phone: 1-800-ANALOG-D



**GaAs MMIC I/Q DOWNCONVERTER
27 - 34 GHz**

Data Taken as SSB Downconverter with External IF 90° Hybrid, IF = 3300 MHz

Conversion Gain vs. Temperature, USB

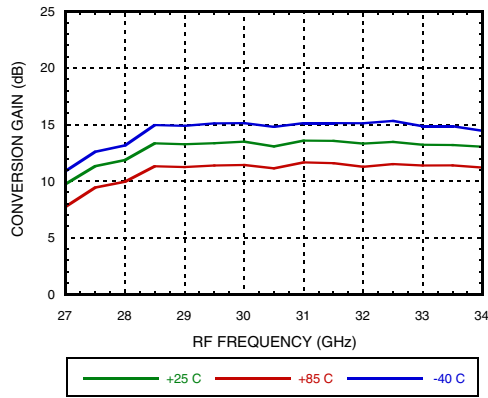

Conversion Gain vs. LO Drive, USB

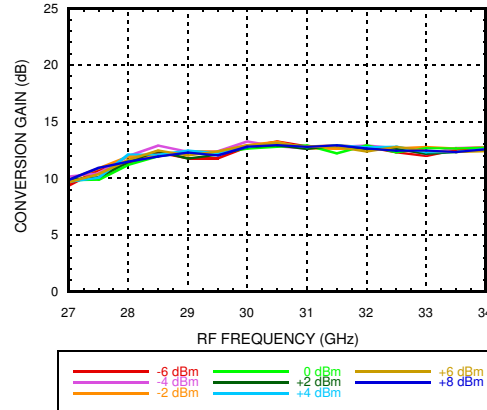
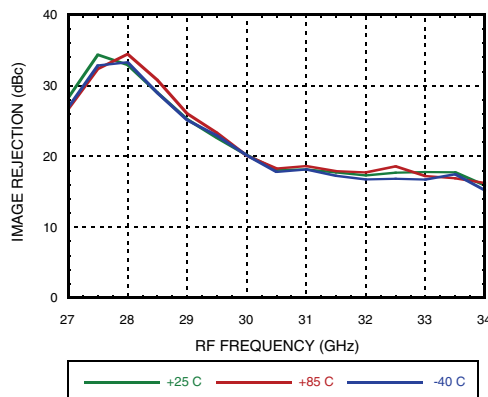
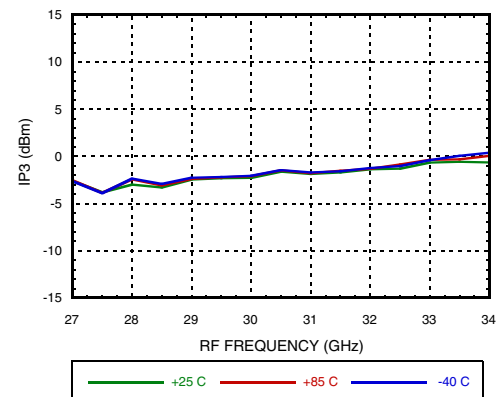

Image Rejection vs. Temperature, USB



Input IP3 vs. Temperature, USB



Input IP3 vs. LO Drive, USB

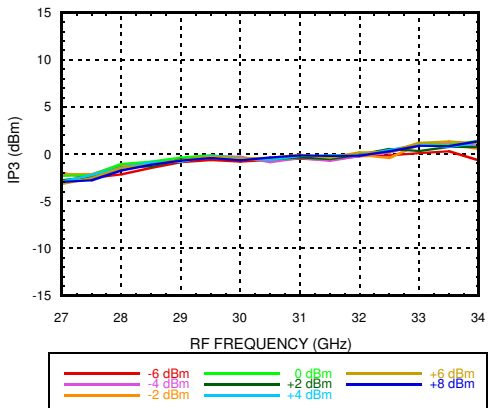

Output IP3 vs. Temperature, USB

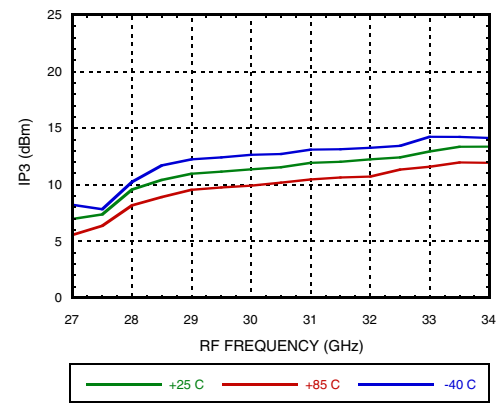

Information furnished by Analog Devices is believed to be accurate and reliable. However, no responsibility is assumed by Analog Devices for its use, nor for any infringements of patents or other rights of third parties that may result from its use. Specifications subject to change without notice. No license is granted by implication or otherwise under any patent or patent rights of Analog Devices. Trademarks and registered trademarks are the property of their respective owners.

For price, delivery, and to place orders: Analog Devices, Inc., One Technology Way, P.O. Box 9106, Norwood, MA 02062-9106 Phone: 781-329-4700 • Order online at www.analog.com Application Support: Phone: 1-800-ANALOG-D



**GaAs MMIC I/Q DOWNCONVERTER
27 - 34 GHz**

**Data Taken as SSB Downconverter with External IF 90° Hybrid, IF = 3300 MHz
Output IP3 vs. LO Drive, USB**

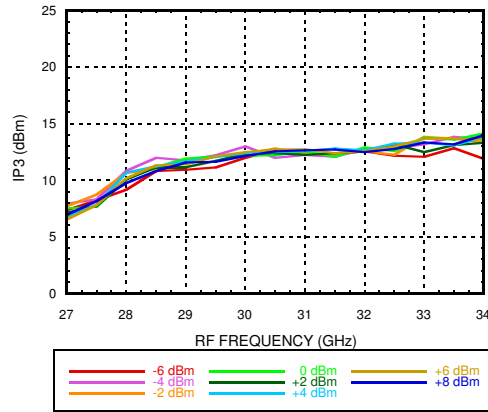

Noise Figure vs. Temperature, USB

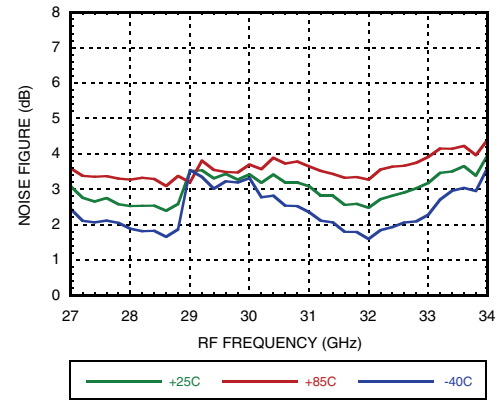

Conversion Gain vs. Temperature, LSB

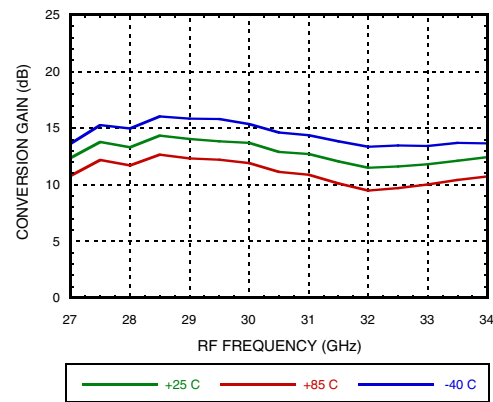

Conversion Gain vs. LO Drive, LSB

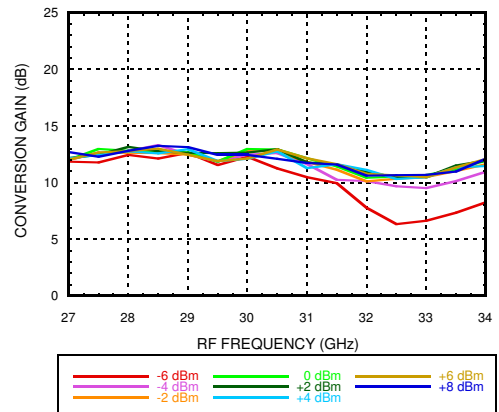
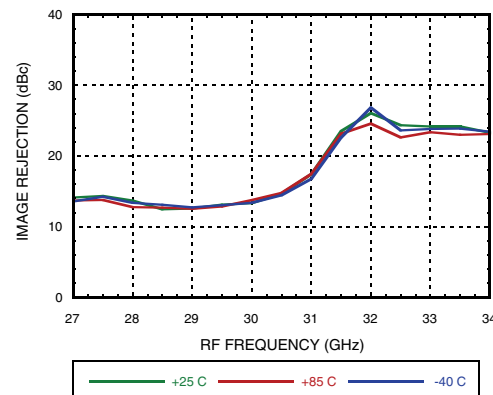
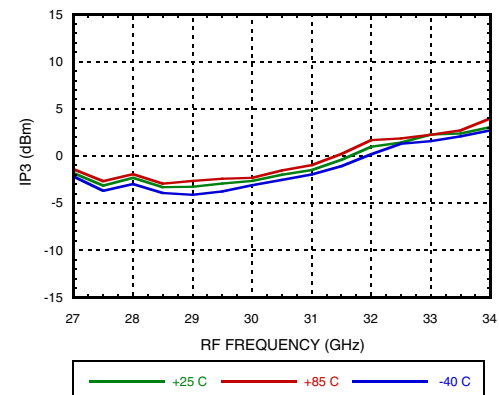

Image Rejection vs. Temperature, LSB



Input IP3 vs. Temperature, LSB



Information furnished by Analog Devices is believed to be accurate and reliable. However, no responsibility is assumed by Analog Devices for its use, nor for any infringements of patents or other rights of third parties that may result from its use. Specifications subject to change without notice. No license is granted by implication or otherwise under any patent or patent rights of Analog Devices. Trademarks and registered trademarks are the property of their respective owners.

For price, delivery, and to place orders: Analog Devices, Inc., One Technology Way, P.O. Box 9106, Norwood, MA 02062-9106 Phone: 781-329-4700 • Order online at www.analog.com Application Support: Phone: 1-800-ANALOG-D



**GaAs MMIC I/Q DOWNCONVERTER
27 - 34 GHz**

Data Taken as SSB Downconverter with External IF 90° Hybrid, IF = 3300 MHz

Input IP3 vs. LO Drive, LSB

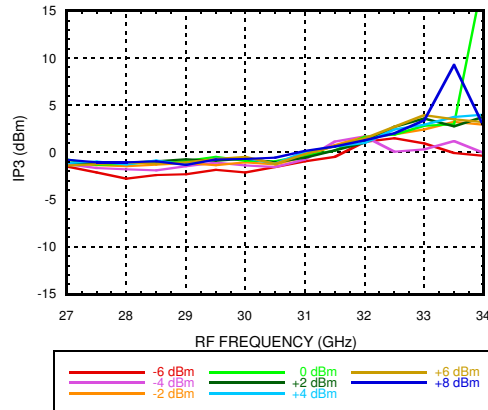

Output IP3 vs. Temperature, LSB

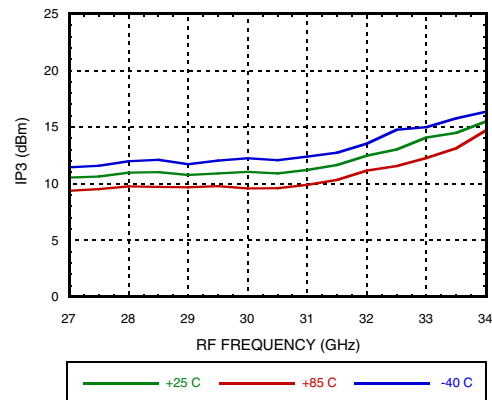

Output IP3 vs. LO Drive, LSB

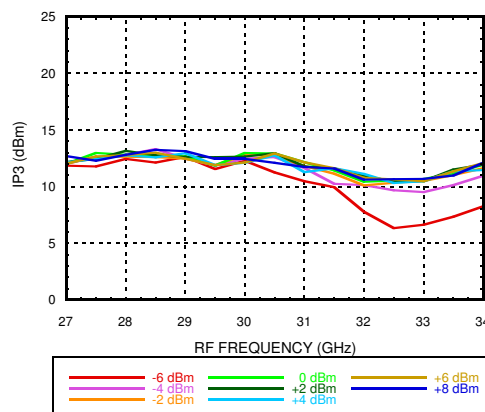

Information furnished by Analog Devices is believed to be accurate and reliable. However, no responsibility is assumed by Analog Devices for its use, nor for any infringements of patents or other rights of third parties that may result from its use. Specifications subject to change without notice. No license is granted by implication or otherwise under any patent or patent rights of Analog Devices. Trademarks and registered trademarks are the property of their respective owners.

For price, delivery, and to place orders: Analog Devices, Inc., One Technology Way, P.O. Box 9106, Norwood, MA 02062-9106
Phone: 781-329-4700 • Order online at www.analog.com
Application Support: Phone: 1-800-ANALOG-D



GaAs MMIC I/Q DOWNCONVERTER 27 - 34 GHz

MxN Spurious Outputs, IF = 1 GHz ^[1]

mRF	nLO				
	0	1	2	3	4
0	x	35	18	49	
1	7	41	0	48	28
2		59	52	64	35
3				85	69

RF = 30 GHz @ -8 dBm

LO = 14.5 GHz @ +2 dBm

All values in dBc below IF power level (1RF -2LO)

Spur values are (M x RF) + (N x LO)

MxN Spurious Outputs, IF = 2 GHz ^[1]

mRF	nLO				
	0	1	2	3	4
0	x	32	18	52	
1	8	48	0	47	31
2		64	61	65	37
3				86	68

RF = 30 GHz @ -8 dBm

LO = 14.0 GHz @ +2 dBm

All values in dBc below IF power level (1RF -2LO)

Spur values are (M x RF) + (N x LO)

MxN Spurious Outputs, IF = 3.3 GHz ^[1]

mRF	nLO				
	0	1	2	3	4
0		42	23	46	
1	7	50	0	38	28
2		79	60	67	43
3				88	63

RF = 30 GHz @ -8 dBm

LO = 13.35 GHz @ +2 dBm

All values in dBc below IF power level (1RF -2LO)

Spur values are (M x RF) + (N x LO)

[1] Data taken without external IF 90° hybrid



**GaAs MMIC I/Q DOWNCONVERTER
27 - 34 GHz**

Typical Application

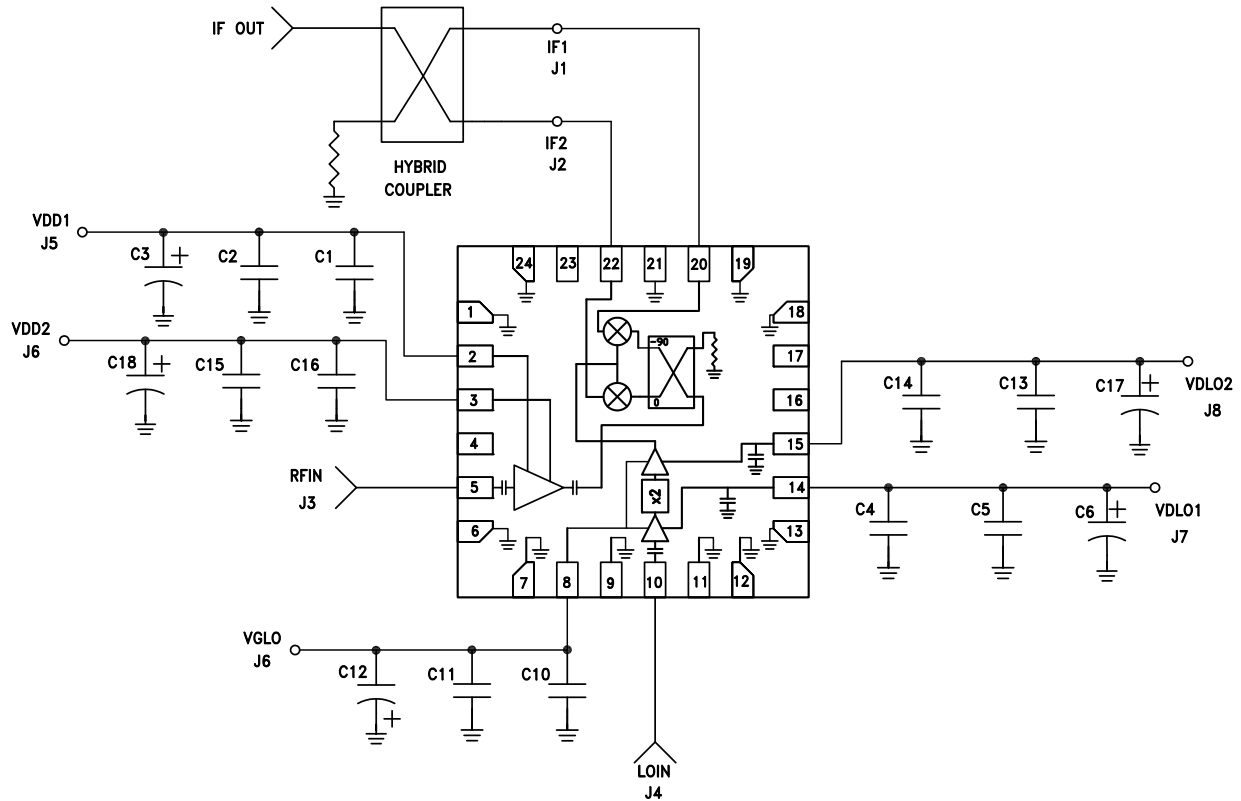

C1, C4, C10, C14, C16	100 pF Capacitor, 0402 Pkg.
C2, C5, C11, C13, C15	0.1 uF Capacitor, 0402 Pkg.
C3, C6, C12, C17, C18	4.7 uF Capacitor, Case A Pkg.



GaAs MMIC I/Q DOWNCONVERTER 27 - 34 GHz

Pin Descriptions

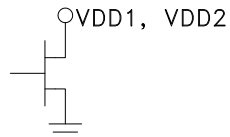
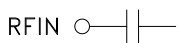
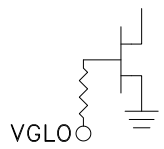
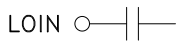
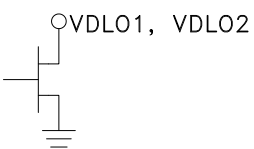
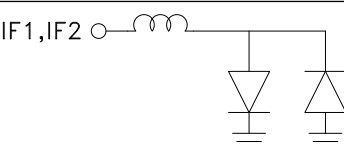
Pin Number	Function	Description	Interface Schematic
1, 4, 6, 7, 9, 11, 12, 13, 18, 19, 21, 24	GND	Ground Connect. These pins and exposed ground paddle must be connected to RF/DC ground.	
2	VDD1	Drain Bias for the low noise amplifier. The recommended DC voltage is 3 V. Refer to the typical application circuit for required external components.	
3	VDD2		
5	RFIN	Radio Frequency Input. This pin is AC coupled and matched to 50 Ohms.	
8	VGLO	Gate Bias for the Local Oscillator. Adjust VGLO from -2 V to 0 V to set total VDLO1 and VDLO2 current to 150mA. Refer to the typical application circuit for required external components.	
10	LOIN	Local Oscillator Input. This pin is AC coupled and matched to 50 Ohms.	
14	VDLO1	Drain Bias for the Multiplier Input Buffer Amp. The recommended DC voltage is 3V. Refer to the typical application circuit for required external components.	
15	VDLO2	Drain Bias for the Multiplier output Buffer Amp. The recommended DC voltage is 3V. Refer to the typical application circuit for required external components.	
16, 17, 23	N/C	No connection required. The pins are not connected internally. However, all data shown herein was measured with these pins connected to RF/DC ground externally.	
20	IF1	Quadrature Intermediate Frequency Inputs. These pins are DC coupled. For applications not requiring operation to DC, use an off chip DC blocking capacitor. For operation to DC, these pins must not source/sink more than 3 mA of current or device non-function and failure may result.	
22	IF2		



GaAs MMIC I/Q DOWNCONVERTER 27 - 34 GHz

Absolute Maximum Ratings

RF Input	+8 dBm
LO Input	+8 dBm
Drain Bias Voltage (Vdd)	+3.5 V
Channel Temperature	175 °C
Continuous P _{diss} (T = 85°C) (derate 18.5 mW/°C above 85°C)	1.66 W
Thermal Resistance (channel to ground paddle)	54.1 °C/W
Storage Temperature Range	-65 to +150 °C
Operating Temperature Range	-40 to +85 °C
ESD Sensitivity (HBM)	250 V (Class 1A)



ELECTROSTATIC SENSITIVE DEVICE
OBSERVE HANDLING PRECAUTIONS

Outline Drawing

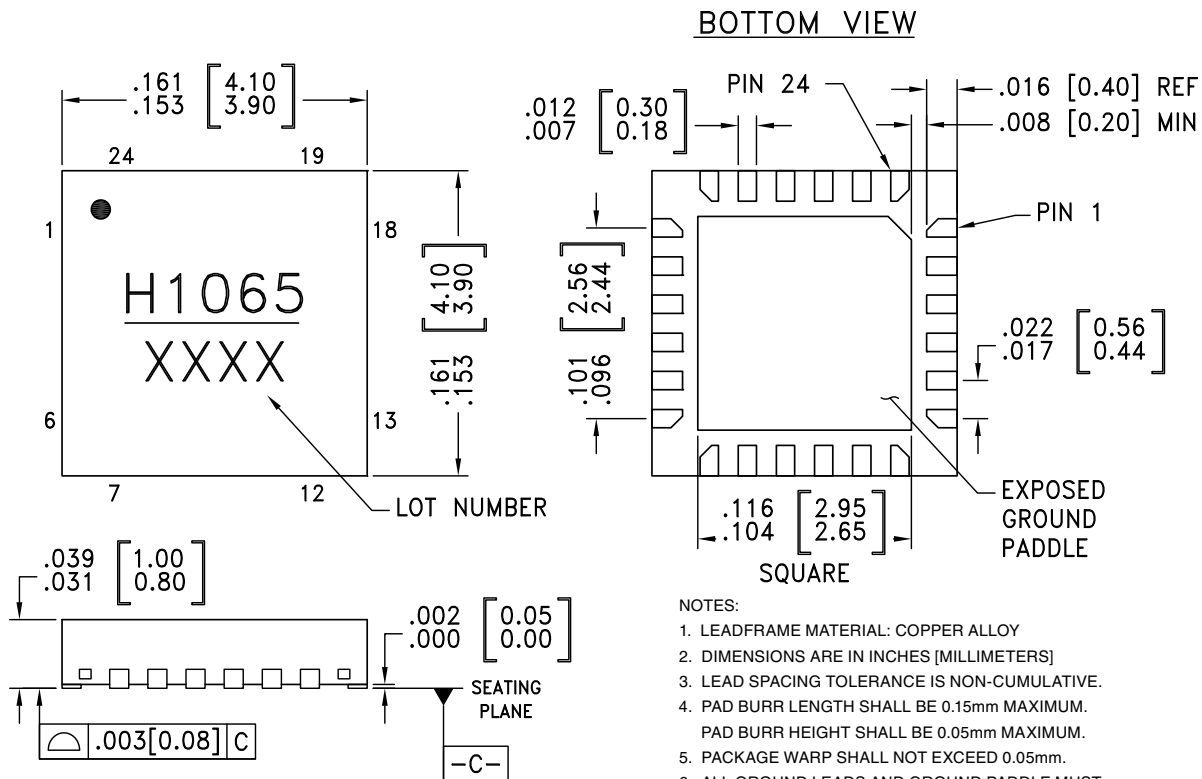

NOTES:

- LEADFRAME MATERIAL: COPPER ALLOY
- DIMENSIONS ARE IN INCHES [MILLIMETERS]
- LEAD SPACING TOLERANCE IS NON-CUMULATIVE.
- PAD BURR LENGTH SHALL BE 0.15mm MAXIMUM.
PAD BURR HEIGHT SHALL BE 0.05mm MAXIMUM.
- PACKAGE WARP SHALL NOT EXCEED 0.05mm.
- ALL GROUND LEADS AND GROUND PADDLE MUST BE SOLDERED TO PCB RF GROUND.
- REFER TO HITTITE APPLICATION NOTE FOR SUGGESTED LAND PATTERN.

Package Information

Part Number	Package Body Material	Lead Finish	MSL Rating	Package Marking ^[2]
HMC1065LP4E	RoHS-compliant Low Stress Injection Molded Plastic	100% Sn 10 micron min	MSL1 ^[1]	H1065 XXXX

[1] Max peak reflow temperature of 260 °C

[2] 4-Digit lot number XXXX



**GaAs MMIC I/Q DOWNCONVERTER
27 - 34 GHz**

Evaluation PCB

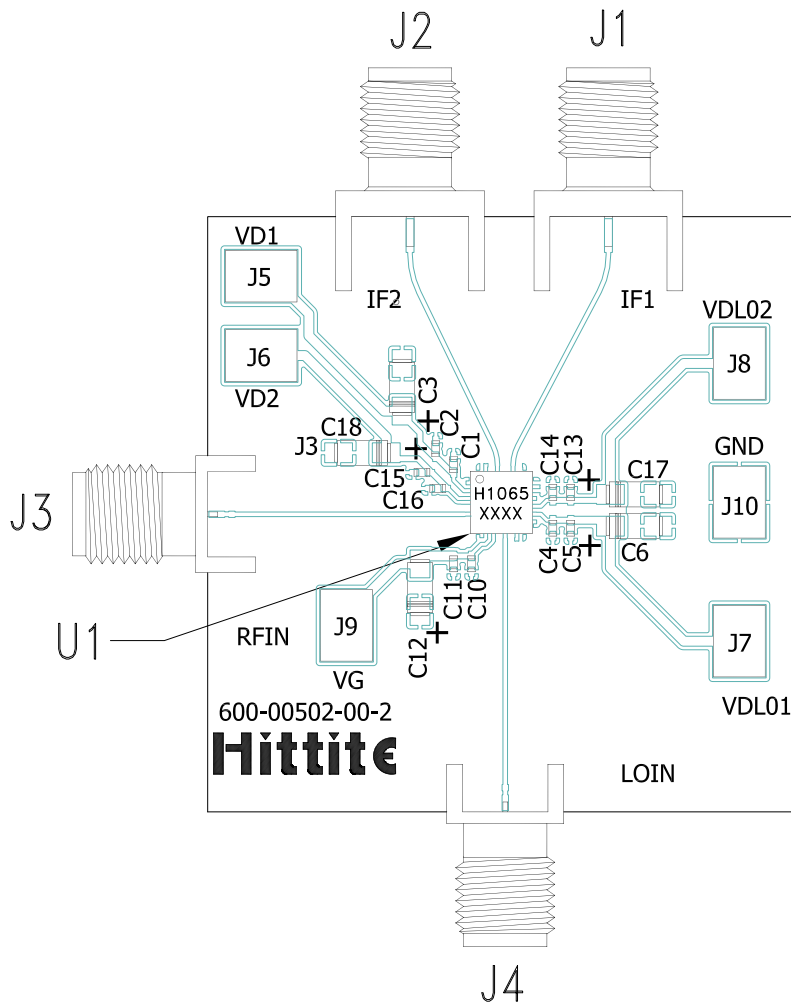

List of Materials for Evaluation PCB Eval01-HMC1065LP4 [1]

Item	Description
J1, J2	SMA SRI
J3, J4	K-Connector SRI
J5 - J10	DC Pins
C1, C4, C10, C14, C16	100 pF Capacitor, 0402 Pkg.
C2, C5, C11, C13, C15	0.1 uF Capacitor, 0402 Pkg.
C3, C6, C12, C17, C18	4.7 uF Capacitor, Case A
U1	HMC1065LP4E Downconverter
PCB [2]	600-00502-00 Evaluation Board

[1] Reference this number when ordering complete evaluation PCB

[2] Circuit Board Material: Arlon 25FR, FR4 or Rogers 4350

The circuit board used in the application should use RF circuit design techniques. Signal lines should have 50 Ohm impedance while the package ground leads and exposed paddle should be connected directly to the ground plane similar to that shown. A sufficient number of via holes should be used to connect the top and bottom ground planes. The evaluation circuit board shown is available from Analog Devices upon request.