



Chipsmall Limited consists of a professional team with an average of over 10 year of expertise in the distribution of electronic components. Based in Hongkong, we have already established firm and mutual-benefit business relationships with customers from,Europe,America and south Asia,supplying obsolete and hard-to-find components to meet their specific needs.

With the principle of “Quality Parts,Customers Priority,Honest Operation,and Considerate Service”,our business mainly focus on the distribution of electronic components. Line cards we deal with include Microchip,ALPS,ROHM,Xilinx,Pulse,ON,Everlight and Freescale. Main products comprise IC,Modules,Potentiometer,IC Socket,Relay,Connector.Our parts cover such applications as commercial,industrial, and automotives areas.

We are looking forward to setting up business relationship with you and hope to provide you with the best service and solution. Let us make a better world for our industry!



Contact us

Tel: +86-755-8981 8866 Fax: +86-755-8427 6832

Email & Skype: info@chipsmall.com Web: www.chipsmall.com

Address: A1208, Overseas Decoration Building, #122 Zhenhua RD., Futian, Shenzhen, China





GaAs MMIC X6 ACTIVE FREQUENCY MULTIPLIER, 71 - 86 GHz

Typical Applications

The HMC1110 is ideal for:

- Point-to-Point & VSAT Radios
- Test Instrumentation
- Military & Space
- Sensors

Features

- High Output Power: +13 dBm
- Low Input Power Drive: 0 to +6 dBm
- 5Fo Harmonic Isolation: +25 dBc
- 7Fo Harmonic Isolation: +40 dBc
- Die Size: 2.44 x 1.35 x 0.1 mm

Functional Diagram

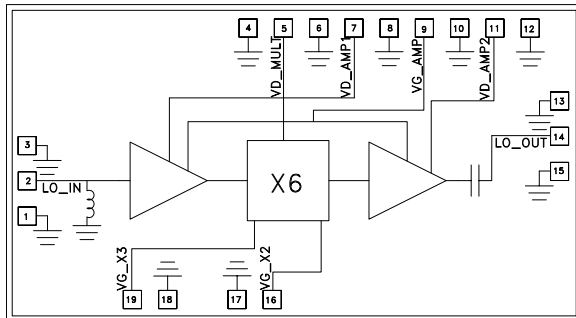

General Description

The HMC1110 is a x6 active broadband frequency multiplier chip utilizing GaAs pHEMT technology. When driven by a +4 dBm signal, the multiplier provides +13 dBm typical output power from 71 to 86 GHz. The 5Fo and 7Fo harmonic isolations with respect to the output signal level are +25 dBc and +40 dBc respectively. The HMC1110 is ideal for use in LO multiplier chains for Pt-to-Pt & VSAT Radios yielding reduced parts count by integrating input and output amplifiers vs. traditional approach which uses discrete components. All data is taken with the chip connected via two 0.025mm (1 mil) wire bonds of minimal length 0.31 mm (12 mils).

Electrical Specifications, $T_A = +25^\circ\text{C}$, $VD_AMP1 = VD_AMP2 = 4V$, $VD_MULT = 1.5V$, 4 dBm Drive Level ^{[1] [2]}

Parameter	Min.	Typ.	Max.	Units
Frequency Range, Input	11.83 - 14.33			GHz
Frequency Range, Output	71 - 86			GHz
Input Power Drive	0 - 6			dBm
Output Power	10	13		dBm
5Fo Harmonic Isolation (with respect to the output signal level)	25			dBc
7Fo Harmonic Isolation (with respect to the output signal level)	40			dBc
Input Return Loss	15			dB
Output Return Loss	12			dB
Supply Current (VD_AMP1 + VD_AMP2) ^[1]	175			mA
Supply Current (VD_MULT) ^[2]	80			mA

[1] Adjust VG_AMP between -2 to 0V to achieve 175 mA total on VD_AMP1 and VD_AMP2.

[2] Adjust VG_X2, VG_X3 between -2 to 0V to achieve 1 - 2 mA on VD_MULT.

HMC1110* PRODUCT PAGE QUICK LINKS

Last Content Update: 02/23/2017

COMPARABLE PARTS

View a parametric search of comparable parts.

DOCUMENTATION

Data Sheet

- HMC1110: GaAs MMIC X6 Active Frequency Multiplier, 71-86 GHz Data Sheet

DESIGN RESOURCES

- HMC1110 Material Declaration
- PCN-PDN Information
- Quality And Reliability
- Symbols and Footprints

DISCUSSIONS

View all HMC1110 EngineerZone Discussions.

SAMPLE AND BUY

Visit the product page to see pricing options.

TECHNICAL SUPPORT

Submit a technical question or find your regional support number.

DOCUMENT FEEDBACK

Submit feedback for this data sheet.



**GaAs MMIC X6 ACTIVE FREQUENCY
MULTIPLIER, 71 - 86 GHz**

Output Power vs. Temperature [1]

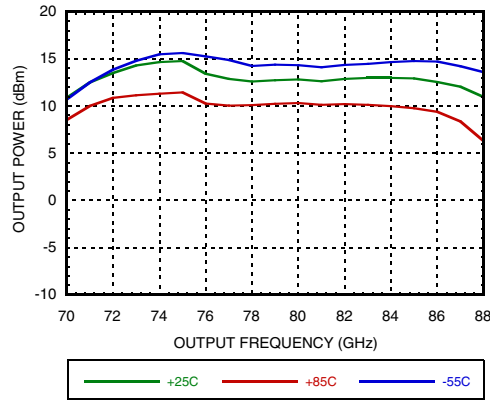

Output Power vs. Drive Level

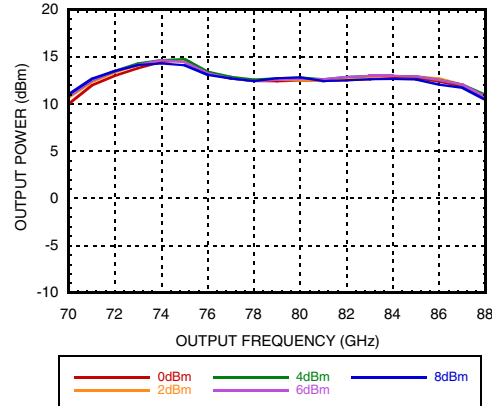

**Output Power vs. VD_AMP
Supply Current, VD_AMP = +4V [1]**

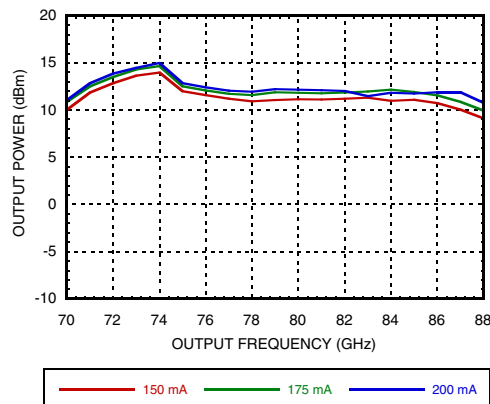

**Output Power vs. VD_AMP
Supply Current, VD_AMP = +3V [1]**

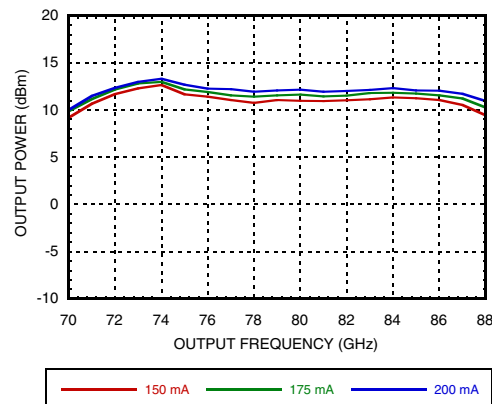

**Output Power vs. VD_MULT
Supply Voltage, VD_AMP = +4V [1]**

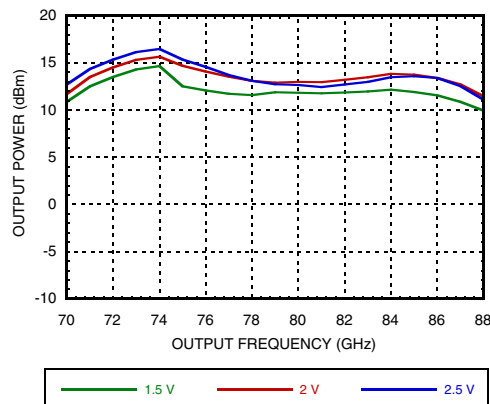

**Output Power vs. VD_MULT
Supply Voltage, VD_AMP = +3V [1]**

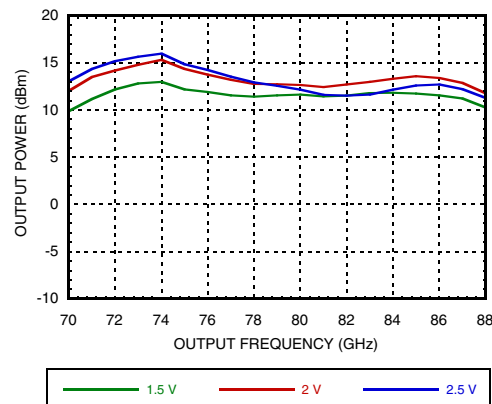

[1] Drive Level = +4 dBm



GaAs MMIC X6 ACTIVE FREQUENCY MULTIPLIER, 71 - 86 GHz

FREQUENCY MULTIPLIER - ACTIVE - CHIP

Input Return Loss

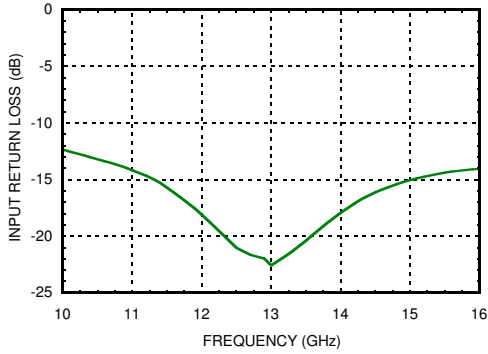

Output Return Loss, RF input = 12.5 GHz

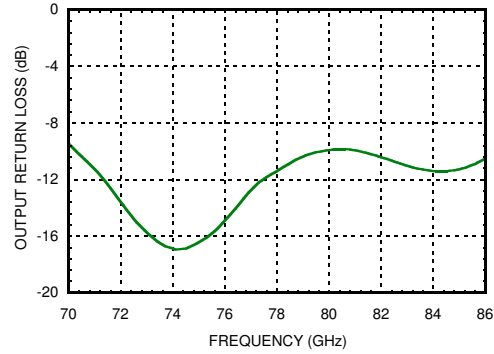

**DC Power vs. Temperature, Pin = 4dBm
VD_MULT = +1.5V, VD_AMP = +4V**

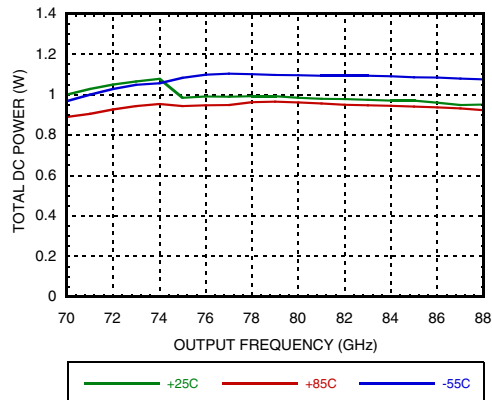

**5th & 7th Harmonic Isolation, Pin = 4dBm
VD_MULT = +1.5V, VD_AMP = +4V**

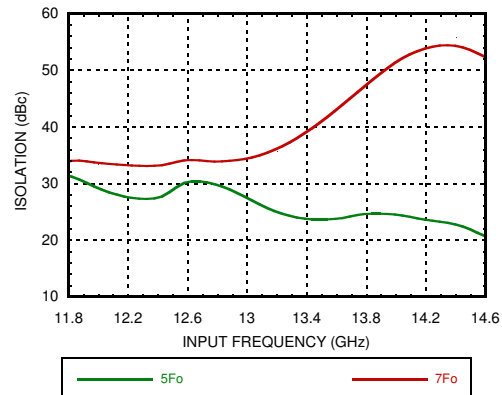

**5th Harmonic Isolation vs. VD_MULT
Pin = 4dBm, VD_AMP = +4V**

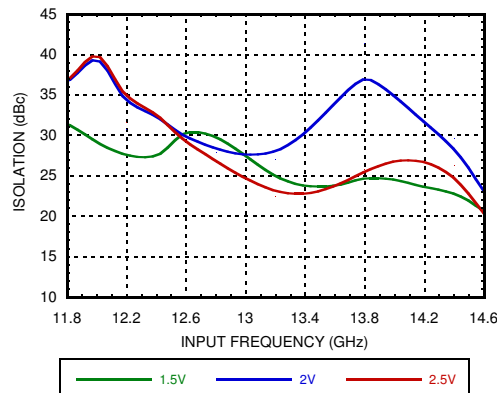

Information furnished by Analog Devices is believed to be accurate and reliable. However, no responsibility is assumed by Analog Devices for its use, nor for any infringements of patents or other rights of third parties that may result from its use. Specifications subject to change without notice. No license is granted by implication or otherwise under any patent or patent rights of Analog Devices. Trademarks and registered trademarks are the property of their respective owners.

For price, delivery, and to place orders: Analog Devices, Inc., One Technology Way, P.O. Box 9106, Norwood, MA 02062-9106 Phone: 781-329-4700 • Order online at www.analog.com Application Support: Phone: 1-800-ANALOG-D



GaAs MMIC X6 ACTIVE FREQUENCY MULTIPLIER, 71 - 86 GHz

Absolute Maximum Ratings

Amplifier Drain Bias Voltage (VD_AMP)	+4.5 V
Multiplier Drain Bias Voltage (VD_MULT)	+3V
RF Input Power	+10 dBm
Junction Temperature	146 °C
Channel Temperature	175 °C
Continuous P _{diss} (T=85 °C) (derate=17.21 mW/ °C above 85°C)	1.55 W
Thermal Resistance (R _{TH}) (junction to die bottom)	58.1 °C/W
Operating Temperature	-55 °C to +85 °C
Storage Temperature	-65 °C to 150 °C
ESD Sensitivity (HBM)	Class 0, passed 150V



ELECTROSTATIC SENSITIVE DEVICE
OBSERVE HANDLING PRECAUTIONS

Outline Drawing

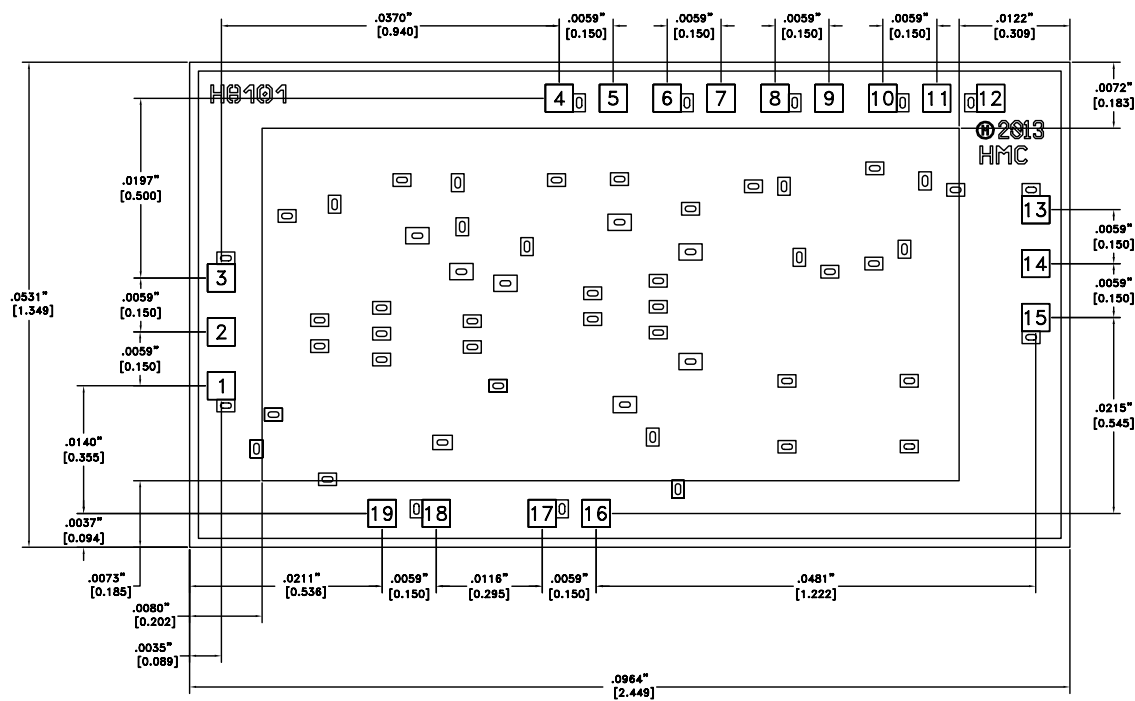

Die Packaging Information ^[1]

Standard	Alternate
GP-2 (Gel Pack)	[2]

[1] Refer to the "Packaging Information" section for die packaging dimensions.

[2] For alternate packaging information contact Hittite Microwave Corporation.



NOTES:

1. ALL DIMENSIONS ARE IN INCHES [MM]
2. DIE THICKNESS IS .004"
3. TYPICAL BOND PAD IS 0.0051" [3.303] SQUARE
4. BACKSIDE METALLIZATION: GOLD
5. BOND PAD METALLIZATION: GOLD
6. BACKSIDE METAL IS GROUND.
7. CONNECTION NOT REQUIRED FOR UNLABELED BOND PADS.
8. OVERALL DIE SIZE ± .002

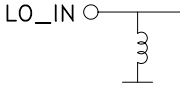
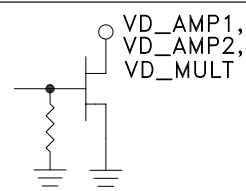
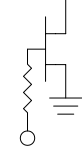
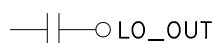

GaAs MMIC X6 ACTIVE FREQUENCY MULTIPLIER, 71 - 86 GHz

Pad Descriptions

Pad Number	Function	Description	Pin Schematic
1, 3, 4, 6, 8, 10, 12, 13, 15, 17, 18	GND	Ground pads must be connected to RF/DC ground.	
2	LO_IN	This pin is DC coupled and matched to 50 Ohms.	
5	VD_MULT	Supply voltage for multiplier. External bypass capacitors of 100 pF, 0.01 μF and 4.7 μF are recommended.	
7, 11	VD_AMP1, VD_AMP2	Supply voltage for input and output amplifiers. External bypass capacitors of 100 pF, 0.01 μF and 4.7 μF are recommended.	
9	VG_AMP	Gate control for amplifier. External bypass capacitors of 100pF, 0.01 μF and 4.7 μF are required. Adjust VG_AMP between -2 to 0V to achieve 175 mA total on VD_AMP1 and VD_AMP2.	
16, 19	VG_X2, VG_X3	Gate control for multiplier. External bypass capacitors of 100 pF, 0.01 μF and 4.7 μF are recommended. Adjust VG_X2, VG_X3 between -2 to 0V to achieve 1 - 2 mA on VD_MULT.	
14	LO_OUT	This pin is AC coupled and matched to 50 Ohms.	
Die Bottom	GND	Die bottom must be connected to RF/DC ground.	



**GaAs MMIC X6 ACTIVE FREQUENCY
MULTIPLIER, 71 - 86 GHz**

Assembly Diagram

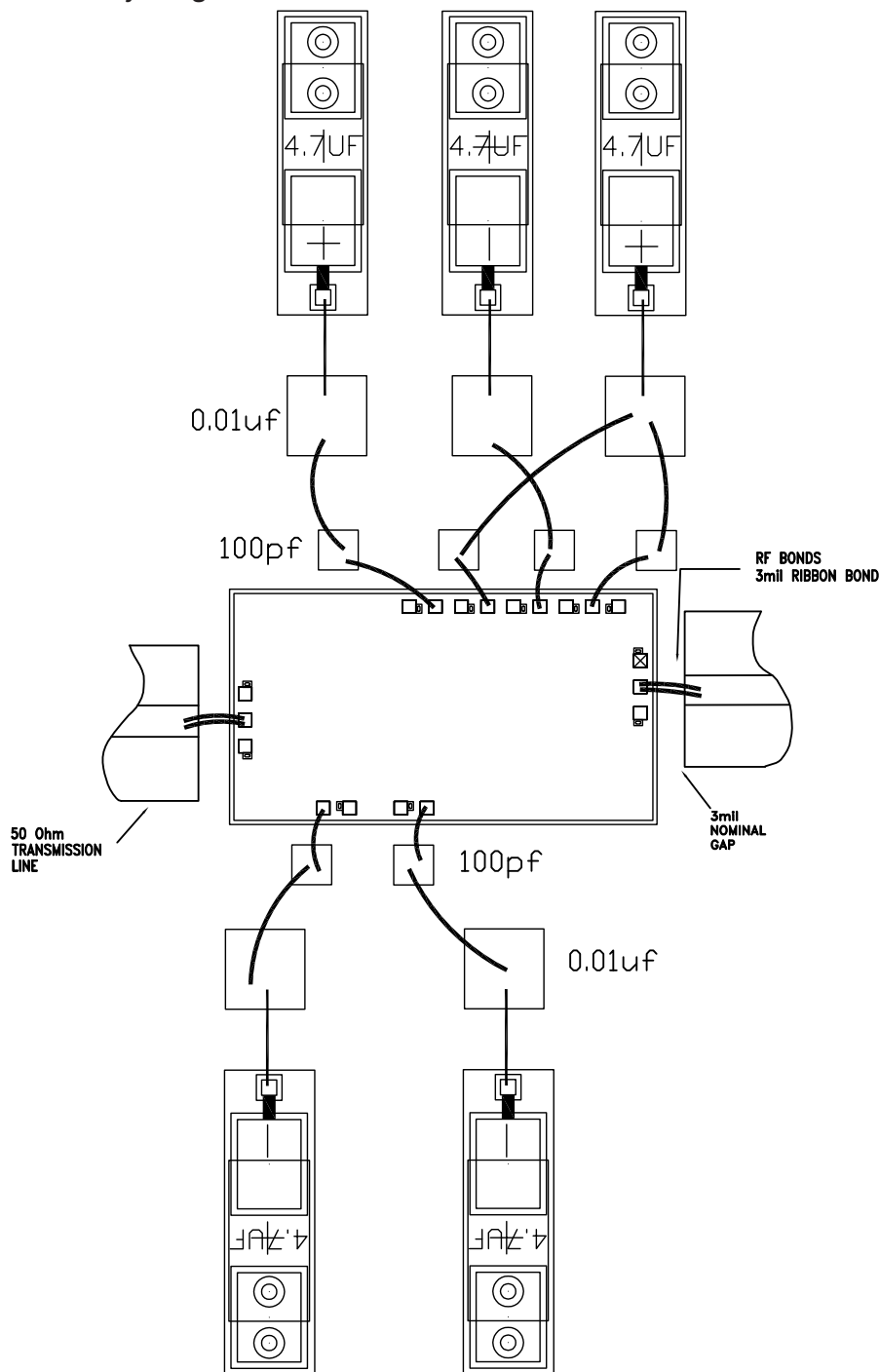

Information furnished by Analog Devices is believed to be accurate and reliable. However, no responsibility is assumed by Analog Devices for its use, nor for any infringements of patents or other rights of third parties that may result from its use. Specifications subject to change without notice. No license is granted by implication or otherwise under any patent or patent rights of Analog Devices. Trademarks and registered trademarks are the property of their respective owners.

For price, delivery, and to place orders: Analog Devices, Inc., One Technology Way, P.O. Box 9106, Norwood, MA 02062-9106 Phone: 781-329-4700 • Order online at www.analog.com Application Support: Phone: 1-800-ANALOG-D



GaAs MMIC X6 ACTIVE FREQUENCY MULTIPLIER, 71 - 86 GHz

Mounting & Bonding Techniques for Millimeterwave GaAs MMICs

The die should be attached directly to the ground plane eutectically or with conductive epoxy (see HMC general Handling, Mounting, Bonding Note).

50 Ohm Microstrip transmission lines on 0.127mm (5 mil) thick alumina thin film substrates are recommended for bringing RF to and from the chip (Figure 1). If 0.254mm (10 mil) thick alumina thin film substrates must be used, the die should be raised 0.150mm (6 mils) so that the surface of the die is coplanar with the surface of the substrate. One way to accomplish this is to attach the 0.102mm (4 mil) thick die to a 0.150mm (6 mil) thick molybdenum heat spreader (moly-tab) which is then attached to the ground plane (Figure 2).

Microstrip substrates should be located as close to the die as possible in order to minimize bond wire length. Typical die-to-substrate spacing is 0.076mm to 0.152 mm (3 to 6 mils).

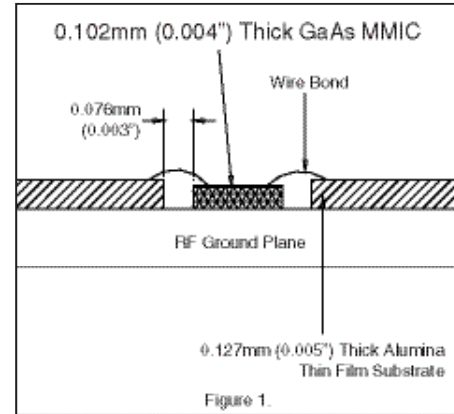

Handling Precautions

Follow these precautions to avoid permanent damage.

Storage: All bare die are placed in either Waffle or Gel based ESD protective containers, and then sealed in an ESD protective bag for shipment. Once the sealed ESD protective bag has been opened, all die should be stored in a dry nitrogen environment.

Cleanliness: Handle the chips in a clean environment. DO NOT attempt to clean the chip using liquid cleaning systems.

Static Sensitivity: Follow ESD precautions to protect against > ± 150V ESD strikes.

Transients: Suppress instrument and bias supply transients while bias is applied. Use shielded signal and bias cables to minimize inductive pick-up.

General Handling: Handle the chip along the edges with a vacuum collet or with a sharp pair of bent tweezers. The surface of the chip may have fragile air bridges and should not be touched with vacuum collet, tweezers, or fingers.

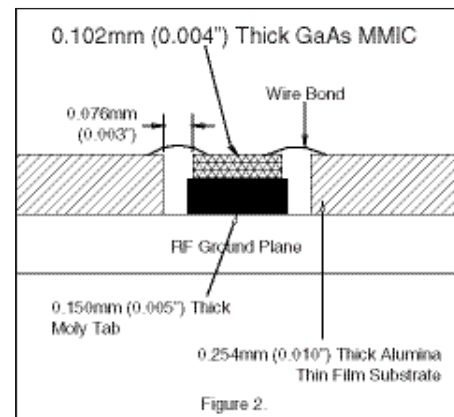

Mounting

The chip is back-metallized and can be die mounted with AuSn eutectic preforms or with electrically conductive epoxy. The mounting surface should be clean and flat.

Eutectic Die Attach: A 80/20 gold tin preform is recommended with a work surface temperature of 255 °C and a tool temperature of 265 °C. When hot 90/10 nitrogen/hydrogen gas is applied, tool tip temperature should be 290 °C. DO NOT expose the chip to a temperature greater than 320 °C for more than 20 seconds. No more than 3 seconds of scrubbing should be required for attachment.

Epoxy Die Attach: Apply a minimum amount of epoxy to the mounting surface so that a thin epoxy fillet is observed around the perimeter of the chip once it is placed into position. Cure epoxy per the manufacturer's schedule.

Wire Bonding

Ball or wedge bond with 0.025mm (1 mil) diameter pure gold wire. Thermosonic wirebonding with a nominal stage temperature of 150 °C and a ball bonding force of 40 to 50 grams or wedge bonding force of 18 to 22 grams is recommended. Use the minimum level of ultrasonic energy to achieve reliable wirebonds. Wirebonds should be started on the chip and terminated on the package or substrate. All bonds should be as short as possible <0.31mm (12 mils).

**GaAs MMIC X6 ACTIVE FREQUENCY
MULTIPLIER, 71 - 86 GHz****Notes**