



Chipsmall Limited consists of a professional team with an average of over 10 year of expertise in the distribution of electronic components. Based in Hongkong, we have already established firm and mutual-benefit business relationships with customers from,Europe,America and south Asia,supplying obsolete and hard-to-find components to meet their specific needs.

With the principle of "Quality Parts,Customers Priority,Honest Operation,and Considerate Service",our business mainly focus on the distribution of electronic components. Line cards we deal with include Microchip,ALPS,ROHM,Xilinx,Pulse,ON,Everlight and Freescale. Main products comprise IC,Modules,Potentiometer,IC Socket,Relay,Connector.Our parts cover such applications as commercial,industrial, and automotives areas.

We are looking forward to setting up business relationship with you and hope to provide you with the best service and solution. Let us make a better world for our industry!



## Contact us

Tel: +86-755-8981 8866 Fax: +86-755-8427 6832

Email & Skype: info@chipsmall.com Web: www.chipsmall.com

Address: A1208, Overseas Decoration Building, #122 Zhenhua RD., Futian, Shenzhen, China





## GaAs MMIC DOUBLE-BALANCED MIXER, 6 - 20 GHz

### Typical Applications

The HMC144LC4 is ideal for:

- Point-to-Point Radios
- Point-to-Multi-Point Radios & VSAT
- Test Equipment & Sensors
- Military End-Use

### Features

- +23 dBm Input IP3
- 35 dB LO/Rf Isolation
- IF Bandwidth: DC to 3 GHz
- RoHS Compliant 4x4 mm SMT Package

### Functional Diagram

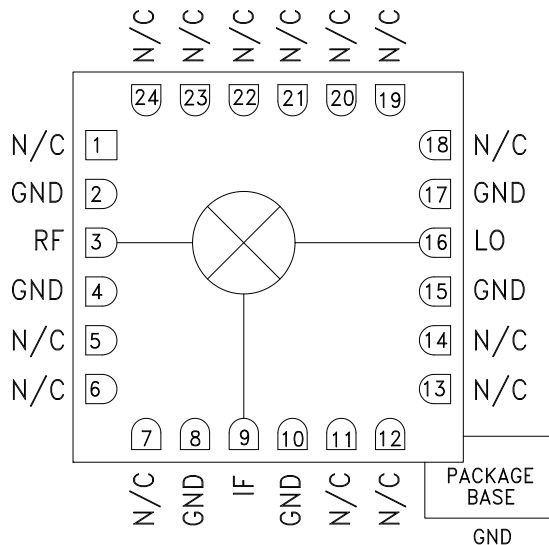

### General Description

The HMC144LC4 is a Double-Balanced MMIC Mixer in a leadless "Pb free" SMT package which can be used as an upconverter or downconverter from 6 to 20 GHz. Broadband operation and 30 to 40 dB isolations are provided by on-chip baluns, which require no external components or DC bias. MMIC mixers are more reliable replacements to hybrid diode mixers assuring consistent conversion loss and isolation performance over high volume production lots. The HMC144LC4 eliminates the need for wire bonding, allowing use of surface mount manufacturing techniques.

### Electrical Specifications, $T_A = +25^\circ C$

| Parameter                | IF = 100 MHz<br>LO = +20 dBm |      |      |         |      |      | Units |
|--------------------------|------------------------------|------|------|---------|------|------|-------|
|                          | Min.                         | Typ. | Max. | Min.    | Typ. | Max. |       |
| Frequency Range, RF & LO | 6 - 12                       |      |      | 12 - 20 |      |      | GHz   |
| Frequency Range, IF      | DC - 3                       |      |      | DC - 3  |      |      | GHz   |
| Conversion Loss          |                              | 9.5  | 11.5 |         | 11   | 13   | dB    |
| Noise Figure (SSB)       |                              | 9.5  | 11.5 |         | 11   | 13   | dB    |
| LO to RF Isolation       | 25                           | 35   |      | 25      | 35   |      | dB    |
| LO to IF Isolation       | 15                           | 20   |      | 15      | 20   |      | dB    |
| RF to IF Isolation       | 15                           | 25   |      | 15      | 25   |      | dB    |
| IP3 (Input)              |                              | 23   |      |         | 23   |      | dBm   |
| 1 dB Compression (Input) | 12                           | 15   |      | 12      | 15   |      | dBm   |

\* Unless otherwise noted, all measurements performed as downconverter, IF= 100 MHz.



**GaAs MMIC DOUBLE-BALANCED MIXER, 6 - 20 GHz**

**Conversion Gain vs. Temperature @ LO = +20 dBm**

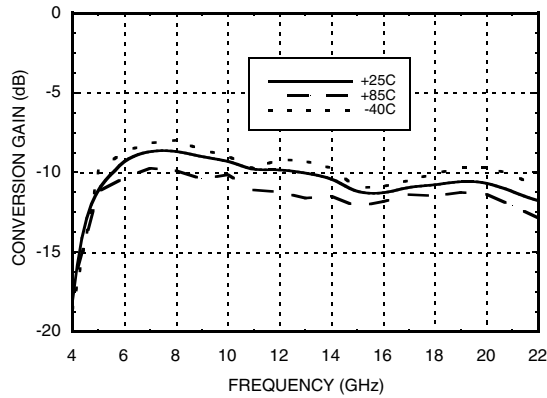

**Isolation @ LO = +20 dBm**

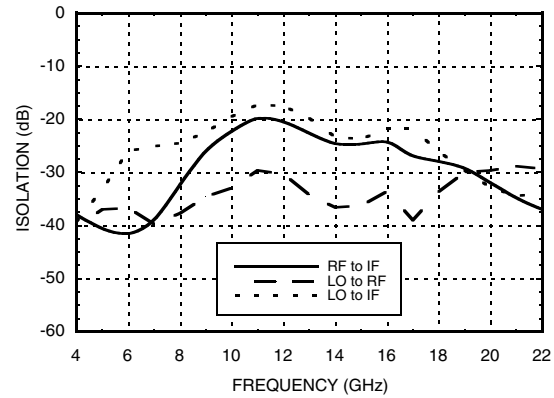

**Conversion Gain vs. LO Drive**

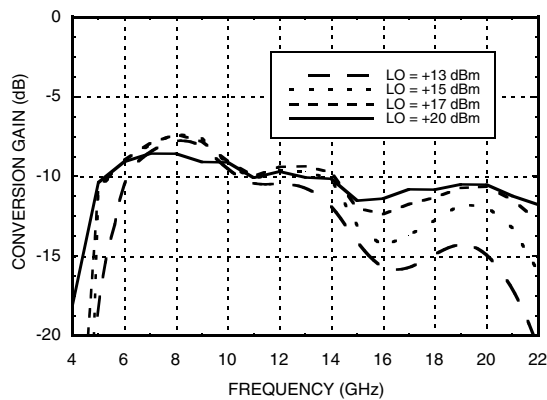

**Return Loss @ LO = +20 dBm**

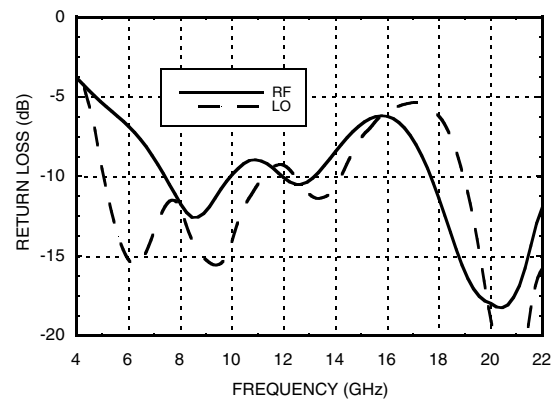

**IF Bandwidth @ LO = +20 dBm**

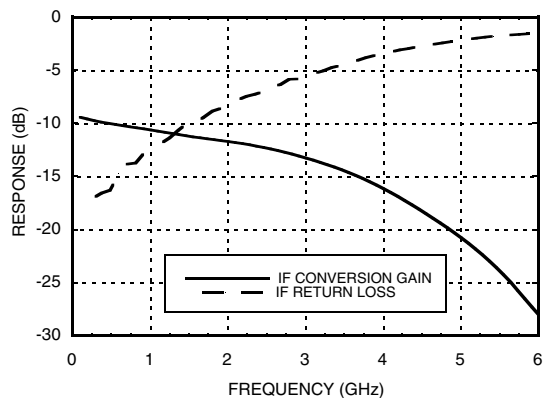

**Upconverter Performance Conversion Gain @ LO = +20 dBm**

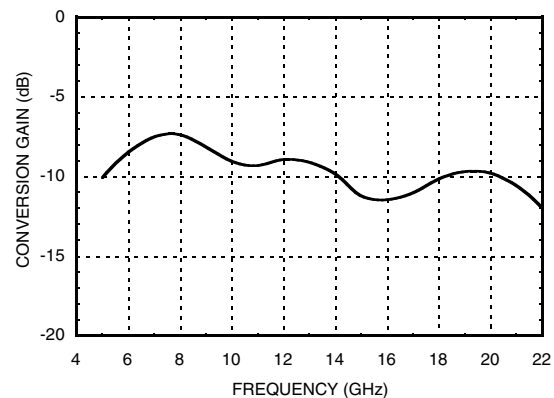

Information furnished by Analog Devices is believed to be accurate and reliable. However, no responsibility is assumed by Analog Devices for its use, nor for any infringements of patents or other rights of third parties that may result from its use. Specifications subject to change without notice. No license is granted by implication or otherwise under any patent or patent rights of Analog Devices. Trademarks and registered trademarks are the property of their respective owners.

For price, delivery, and to place orders: Analog Devices, Inc., One Technology Way, P.O. Box 9106, Norwood, MA 02062-9106 Phone: 781-329-4700 • Order online at [www.analog.com](http://www.analog.com) Application Support: Phone: 1-800-ANALOG-D





**GaAs MMIC DOUBLE-BALANCED MIXER, 6 - 20 GHz**

**Input IP3 vs. LO Drive\***

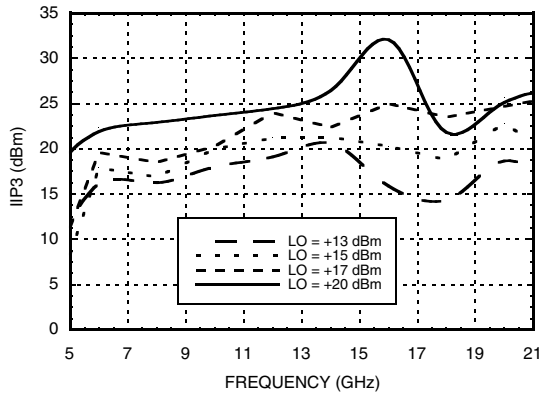

**Input IP3 vs. Temperature @ LO = +20 dBm\***

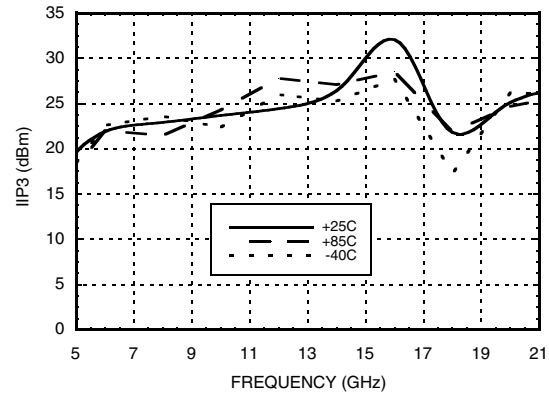

**Input IP2 vs. LO Drive \***

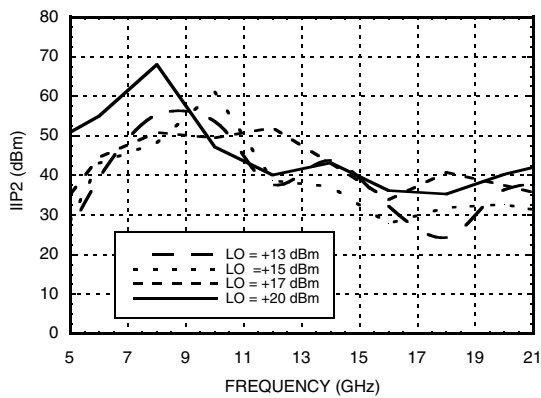

**Input P1dB vs. Temperature @ LO = +20 dBm**

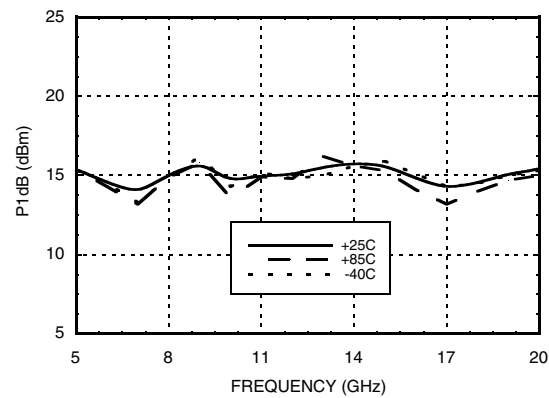

**MxN Spurious @ IF Port**

| mRF | nLO |     |     |     |     |
|-----|-----|-----|-----|-----|-----|
|     | 0   | 1   | 2   | 3   | 4   |
| 0   | XX  | 0   | 5   | 37  | N/A |
| 1   | 7   | 0   | 49  | 42  | 54  |
| 2   | 47  | 66  | 44  | 56  | 57  |
| 3   | >95 | >95 | >95 | 58  | 77  |
| 4   | N/A | >95 | >95 | >95 | >95 |

RF = 12 GHz @ -10 dBm  
 LO = 12.1 GHz @ 20 dBm  
 All values in dBc relative to the IF power level.  
 Measured as downconverter.

**Harmonics of LO**

| LO Freq. (GHz) | nLO Spur @ RF Port |    |    |     |
|----------------|--------------------|----|----|-----|
|                | 1                  | 2  | 3  | 4   |
| 9              | 25                 | 18 | 46 | 53  |
| 10.5           | 25                 | 20 | 52 | 66  |
| 12             | 27                 | 24 | 47 | 63  |
| 13.5           | 27                 | 33 | 61 | N/A |
| 15             | 27                 | 47 | 67 | N/A |
| 16.5           | 24                 | 52 | 63 | N/A |

LO = +20 dBm  
 All values in dBc below input LO level @ RF port.

\* Two-tone input power = 0 dBm each tone, 1 MHz spacing.

**GaAs MMIC DOUBLE-BALANCED  
MIXER, 6 - 20 GHz****Absolute Maximum Ratings**

|                       |                |
|-----------------------|----------------|
| RF / IF Input         | +15 dBm        |
| LO Drive              | +27 dBm        |
| IF DC Current         | ±2 mA          |
| Storage Temperature   | -65 to +150 °C |
| Operating Temperature | -40 to +85 °C  |
| ESD Sensitivity (HBM) | Class 1A       |

**ELECTROSTATIC SENSITIVE DEVICE  
OBSERVE HANDLING PRECAUTIONS**



## GaAs MMIC DOUBLE-BALANCED MIXER, 6 - 20 GHz

### Outline Drawing

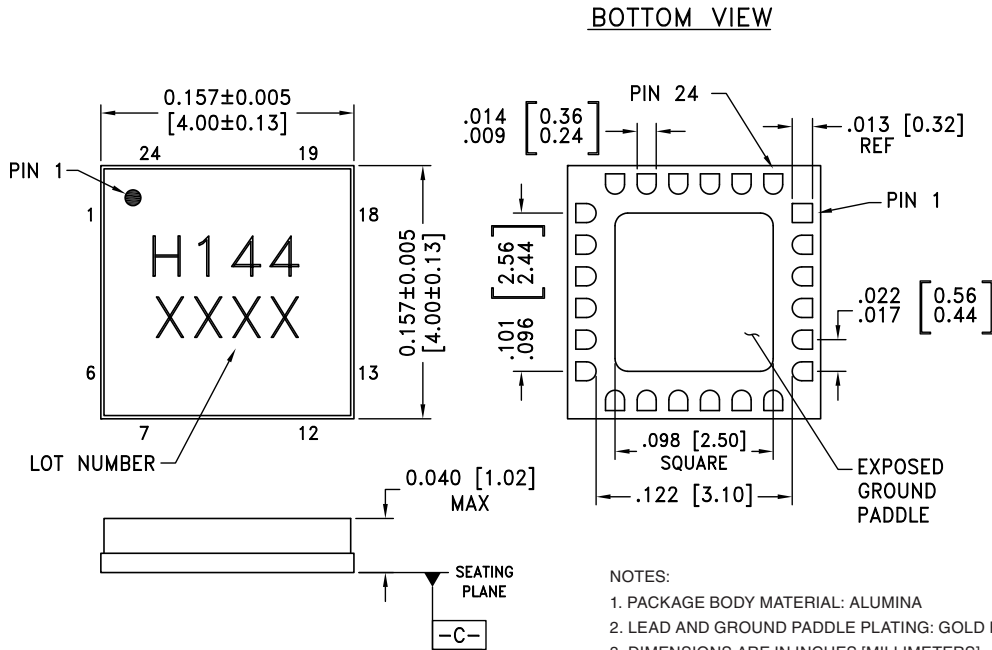

**NOTES:**

1. PACKAGE BODY MATERIAL: ALUMINA
2. LEAD AND GROUND PADDLE PLATING: GOLD FLASH OVER NI.
3. DIMENSIONS ARE IN INCHES [MILLIMETERS].
4. LEAD SPACING TOLERANCE IS NON-CUMULATIVE.
5. PACKAGE WARP SHALL NOT EXCEED 0.05mm DATUM -C-
6. ALL GROUND LEADS AND GROUND PADDLE MUST BE SOLDERED TO PCB RF GROUND.

### Package Information

| Part Number | Package Body Material | Lead Finish      | MSL Rating          | Package Marking <sup>[2]</sup> |
|-------------|-----------------------|------------------|---------------------|--------------------------------|
| HMC144LC4   | Alumina, White        | Gold over Nickel | MSL3 <sup>[1]</sup> | H144<br>XXXX                   |

[1] Max peak reflow temperature of 260 °C

[2] 4-Digit lot number XXXX



## GaAs MMIC DOUBLE-BALANCED MIXER, 6 - 20 GHz

### Pin Descriptions

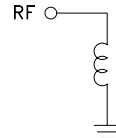
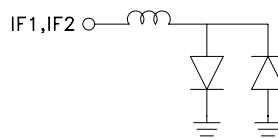
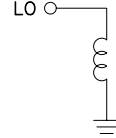
| Pin Number                 | Function | Description   | Interface Schematic  |
|----------------------------|----------|---|--|
| 1, 5 - 7, 11 - 14, 18 - 24 | N/C      | No Connection. These pins may be connected to RF/DC ground. Performance will not be affected.   |  |
| 2, 4, 8, 10, 15, 17        | GND      | These pins and package bottom must be connect to RF/DC ground.  |   |
| 3                          | RF       | This pin is AC coupled and matched to 50 Ohms from 6 - 20 GHz   |   |
| 9                          | IF       | This pin is DC coupled. For applications not requiring operation to DC, this port should be DC blocked externally using a series capacitor whose value has been chosen to pass the necessary IF frequency range. For operation to DC, this pin must not source/sink more than 2 mA of current or die non-function and possible die failure will result. |   |
| 16                         | LO       | This pin is AC coupled and matched to 50 Ohms from 6 - 20 GHz   |  |



**GaAs MMIC DOUBLE-BALANCED  
MIXER, 6 - 20 GHz**

**Evaluation PCB**

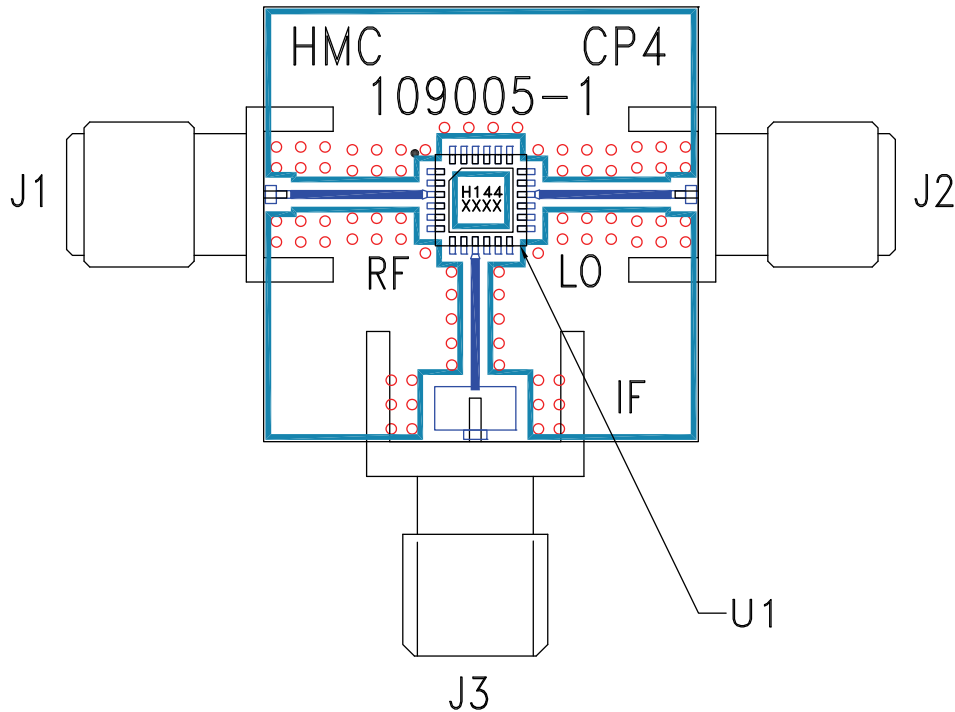

**List of Materials for Evaluation PCB 109010 [1]**

| Item    | Description                      |
|---------|----------------------------------|
| J1 - J2 | PCB Mount SMA RF Connector, SRI  |
| J3      | PCB Mount SMA Connector, Johnson |
| U1      | HMC144LC4                        |
| PCB [2] | 109005 Evaluation Board          |

[1] Reference this number when ordering complete evaluation PCB

[2] Circuit Board Material: Rogers 4350

The circuit board used in the application should use RF circuit design techniques. Signal lines should have 50 Ohm impedance while the package ground leads and exposed paddle should be connected directly to the ground plane similar to that shown. A sufficient number of via holes should be used to connect the top and bottom ground planes. The evaluation circuit board shown is available from Hittite upon request.



**GaAs MMIC DOUBLE-BALANCED  
MIXER, 6 - 20 GHz**